

# SSM-AQUO

Static smart cold water meter



Revision C - Edition 02/2024

**USE, MAINTENANCE  
AND WARNING  
MANUAL**



# 1 - INTRODUCTION

## FOREWORD

All rights reserved. No part of this publication may be reproduced, distributed, translated into other languages or transmitted by any electronic or mechanical media, including photocopies, recording or any other storage and retrieval system, for any other purposes that are not exclusively the personal use of the buyer, without the express written permission of the Manufacturer.

The manufacturer is in no way responsible for the consequences of operations carried out in a manner not in accordance with the manual.

## GENERAL REMARKS

All operating, maintenance instructions and recommendations described in this manual must be followed to in order to:

- obtain the best possible performance from the equipment;
- keep the equipment in efficient conditions.

Training the personnel in charge is essential in order to:

- use and service the equipment properly;
- correctly apply the safety alerts and recommended procedures.

### **NOTICE!**

**Details of the product may differ from the images in this document.**

Revision: C

**COPYRIGHT 2024**

**© PIETRO FIORENTINI S.P.A.**



## 1.1 - REVISION HISTORY

Revision index	Date	Revision contents
<b>A</b>	08/2023	First issue
<b>B</b>	02/2024	<ul style="list-style-type: none"><li>• Chapter 4: updated Tab. 4.20</li><li>• Chapter 6: updated Dimension L for DN 15 in Tab. 6.32</li></ul>
<b>C</b>	03/2024	Chapter 4: updated Tab. 4.21

Tab. 1.1.

## INDICE

<b>1 - INTRODUCTION .....</b>	<b>3</b>
1.1 - REVISION HISTORY.....	5
<b>2 - GENERAL INFORMATION .....</b>	<b>9</b>
2.1 - MANUFACTURER IDENTIFICATION .....	9
2.2 - IDENTIFICATION OF THE PRODUCT .....	9
2.3 - REGULATORY FRAMEWORK.....	10
2.4 - WARRANTY .....	10
2.4.1 - REFERENCE OPERATING CONDITIONS .....	11
2.5 - ADDRESSEES, SUPPLY AND STORAGE OF THE MANUAL .....	12
2.6 - LANGUAGE .....	12
2.7 - SYMBOLS USED IN THE MANUAL.....	13
2.8 - EQUIPMENT IDENTIFICATION .....	14
2.8.1 - IDENTIFIER OF THE LOGIC DEVICE .....	15
2.8.1.1 - TYPE OF GAUGE .....	15
2.8.1.2 - REMOTE COMMUNICATION TYPE .....	16
2.8.2 - DESCRIPTION OF IDENTIFYING ELEMENTS .....	16
2.9 - GLOSSARY OF MEASUREMENT UNITS.....	18
2.10 - QUALIFIED PROFESSIONAL FIGURES.....	18
<b>3 - SAFETY .....</b>	<b>19</b>
3.1 - GENERAL SAFETY WARNINGS.....	19
3.1.1 - CONNECTING TO OTHER DEVICES.....	19
3.1.2 - POWER SUPPLY DEVICES .....	19
3.1.3 - SAFETY INSTRUCTIONS FOR INSTALLATION.....	20
3.2 - PERSONAL PROTECTIVE EQUIPMENT.....	21
3.3 - OBLIGATIONS AND PROHIBITIONS .....	22
3.4 - RESIDUAL RISKS .....	23
3.5 - SAFETY AND FRAUD PREVENTION .....	24
3.6 - SAFETY PICTOGRAMS .....	25
3.7 - NOISE LEVEL .....	25

## 4 - DESCRIPTION AND OPERATION ..... 27

4.1 - GENERAL DESCRIPTION .....	27
4.1.1 - POWER SUPPLY DEVICES .....	28
4.1.1.1 - CONNECTION OF THE POWER SUPPLY DEVICES .....	28
4.1.1.2 - POWER SUPPLY STATUS .....	28
4.1.2 - ACQUISITION OF THE MEASURE.....	29
4.1.3 - EVENTS AND DIAGNOSTICS.....	29
4.1.4 - ACTIVATION AND CONFIGURATION.....	29
4.1.5 - COMMUNICATION INTERFACES .....	29
4.1.6 - USER INTERFACE.....	30
4.2 - INTENDED USE .....	30
4.2.1 - ENVISAGED USE .....	30
4.2.2 - REASONABLY FORESEEABLE MISUSE .....	30
4.3 - TECHNICAL DATA .....	31

## 5 - USER INTERFACE..... 33

5.1 - GENERAL DESCRIPTION .....	33
5.2 - LCD DISPLAY DESCRIPTION .....	34
5.3 - NAVIGATION PROCEDURE .....	35
5.3.1 - SEQUENCE OF AVAILABLE MENUS.....	35
5.3.2 - ALARMS .....	36
5.4 - DATA LOGGER .....	37
5.5 - RADIO TRANSMITTED PAYLOAD .....	37

## 6 - TRANSPORT AND HANDLING ..... 39

6.1 - SPECIFIC WARNINGS FOR TRANSPORT AND HANDLING .....	39
6.1.1 - PACKAGING AND FASTENERS USED FOR TRANSPORT .....	40
6.2 - PACKAGING CONTENT.....	40
6.3 - PHYSICAL CHARACTERISTICS OF THE EQUIPMENT .....	41
6.3.1 - SSM-AQUO .....	41
6.4 - EQUIPMENT ANCHORING AND LIFTING METHOD.....	42
6.4.1 - FORKLIFT HANDLING METHOD.....	43
6.5 - PACKAGING REMOVAL.....	45
6.5.1 - PACKAGING DISPOSAL .....	45
6.6 - STORAGE AND ENVIRONMENTAL CONDITIONS .....	46

<b>7 - INSTALLATION .....</b>	<b>47</b>
7.1 - GENERAL WARNINGS .....	47
7.2 - INSTALLATION PRE-REQUISITES.....	47
7.2.1 - ALLOWED ENVIRONMENTAL CONDITIONS.....	47
7.3 - CHECKS BEFORE INSTALLATION.....	48
7.4 - SPECIFIC SAFETY INSTRUCTIONS FOR THE INSTALLATION STEP .....	48
7.5 - INSTALLATION REQUIREMENTS.....	49
7.6 - INSTALLATION PROCEDURE .....	50
7.7 - TIGHTENING TORQUES.....	51
7.8 - EQUIPMENT ADJUSTMENTS.....	51
<b>8 - CONFIGURATION.....</b>	<b>53</b>
8.1 - SAFETY REQUIREMENTS FOR CONFIGURATION .....	53
8.2 - EQUIPMENT CONFIGURATION .....	53
8.2.1 - USING THE NFC DRIVER.....	53
8.3 - VERIFY CORRECT CONFIGURATION.....	53
8.4 - CONNECTING TO OTHER DEVICES .....	53
<b>9 - MAINTENANCE AND FUNCTIONAL CHECKS.....</b>	<b>55</b>
9.1 - ROUTINE MAINTENANCE .....	55
9.2 - SPECIAL MAINTENANCE .....	55
<b>10 - UNINSTALLATION AND DISPOSAL .....</b>	<b>57</b>
10.1 -QUALIFICATION OF THE OPERATORS IN CHARGE.....	57
10.2 -UNINSTALLATION.....	57
10.3 -INFORMATION REQUIRED IN CASE OF NEW INSTALLATION.....	58
10.4 -STORAGE OF THE BATTERIES .....	58
10.5 -INFORMATION REQUIRED IN CASE OF RE-INSTALLATION.....	58
10.6 -DISPOSAL INFORMATION.....	59
10.6.1 - DISPOSING OF THE BATTERIES .....	60
10.6.1.1 - BATTERY PACKAGING.....	60
<b>11 - RECOMMENDED SPARE PARTS .....</b>	<b>61</b>
11.1 -GENERAL WARNINGS .....	61
11.2 -HOW TO REQUEST SPARE PARTS.....	61



## 2 - GENERAL INFORMATION

### 2.1 - MANUFACTURER IDENTIFICATION

<b>Manufacturer</b>	PIETRO FIORENTINI S.P.A.
<b>Address</b>	Via Enrico Fermi, 8/10 36057 Arcugnano (VI) - ITALY <b>Tel. +39 0444 968511    Fax +39 0444 960468</b> <b>www.fiorentini.com    sales@fiorentini.com</b>

Tab. 2.2.

#### NOTICE!

For any problems with the equipment, please contact **PIETRO FIORENTINI S.p.A.**

### 2.2 - IDENTIFICATION OF THE PRODUCT

<b>Equipment</b>	CONTATORE SMART STATICO PER ACQUA FREDDA
<b>Series</b>	SSM-AQUO
<b>Available models</b>	<ul style="list-style-type: none"> <li>• SSM-AQUO DN 15</li> <li>• SSM-AQUO DN 20</li> <li>• SSM-AQUO DN 25</li> <li>• SSM-AQUO DN 32</li> <li>• SSM-AQUO DN 40</li> </ul>

Tab. 2.3.

## 2.3 - REGULATORY FRAMEWORK

PIETRO FIORENTINI S.P.A. with registered office in Arcugnano (Italy) - Via E. Fermi, 8/10, declares that the equipment of the SSM-AQUO series described in this manual is designed, manufactured, tested and checked in compliance with:

- Directive 2014/32/EU "MID" - DIRECTIVE 2014/32/EU OF THE EUROPEAN PARLIAMENT AND OF THE COUNCIL of 26 February 2014 on the harmonisation of the laws of the Member States relating to making available on the market of measuring instruments (recast)
- Directive 2014/53/EU "RED" OF THE EUROPEAN PARLIAMENT AND OF THE COUNCIL of 2014/53 April 16, 2014 on the harmonisation of the laws of the Member States concerning the making available on the market of radio equipment and that supersede directive 1999/5/EC
- Directive 2011/65/EU and Delegated Directive 2015/863/EU "RoHS 2"
- European Directive 98/83/EC and European Regulation 10/2011 - Ministerial Decree No. 174 of 06/04/2004 - Official Journal No. 166 of 17/07/2004 Implementation of Directive 98/83/EC in Italy
- EU declaration of conformity of the product's hygienic suitability for potable water: KTW (Germany), PZH (Poland)
- EN 61000-6-1 -2 and -3 Electromagnetic compatibility
- EN 60529, Degrees of protection provided by enclosures (IP code)
- EN13757-4 Wireless MBUS protocol
- ISO 4064-1:2017 Water meters for cold potable water and hot water - Part 1: Metrological and technical requirements
- OIML R49-1:2013 Water meters for cold potable water and hot water - Part 1: Metrological and technical requirements
- WHO Specification Issue 3.0.0-2013-10-18
- LoRaWAN® 1.0.3

### NOTICE!

**For specific type approvals, see the appropriate section on the Manufacturer's website: <https://www.fiorentini.com>**

### NOTICE!

**The declaration of conformity in its original version is delivered together with the equipment.**

## 2.4 - WARRANTY

PIETRO FIORENTINI S.P.A. guarantees that the equipment was manufactured using the best materials, with high quality workmanship, and complies with the quality requirements, specifications and performance set out in the order.

The warranty shall be considered null and void and PIETRO FIORENTINI S.P.A. shall not be liable for any damage and/or malfunctions:

- due to any acts or omissions of the purchaser or end-user, or any of their carriers, employees, agents, or any third party or entity;
- in the event that the purchaser, or a third party, makes changes to the equipment supplied by PIETRO FIORENTINI S.P.A. without the prior written approval of the latter;
- in the event of failure by the purchaser to comply with the instructions contained in this manual, as provided by PIETRO FIORENTINI S.P.A.

### NOTICE!

**The warranty conditions are specified in the commercial contract.**

### 2.4.1 - REFERENCE OPERATING CONDITIONS

The reference operating conditions for battery life calculations can be found at Tab. 2.4:

Operative condition	Reference indications
<b>User interface</b>	Display always active (automatic menu scrolling) 15 minutes per month (NFC/Zvei interface)
<b>Upgrade firmware code</b>	Local: No. 3 (within the equipment's service life)
<b>Communication</b>	Wireless M-Bus version: <ul style="list-style-type: none"> <li>• Mode T1: 10 hours of transmission/day (every 60 seconds)</li> <li>• Mode C1: 10 hours of transmission/day (every 16 sec.)</li> </ul>
	LoRaWAN version: <ul style="list-style-type: none"> <li>• Up to 4 transmissions per day in SF12</li> </ul>
	Version NBloT: <ul style="list-style-type: none"> <li>• 1 recording per year</li> <li>• 1 communication per day</li> </ul>

Tab. 2.4.

Ambient temperature has an effect on battery life. The operating profile used to calculate the battery life expectancy is indicated in Tab. 2.5:

	Reference indications
	44,35% of the time at +5 °C
	43% of the time at +20 °C
	11.8% of the time at +35 °C
	0.5% of the time at +50 °C
	0.25% of the time at +60 °C
	0.1% of the time at +70 °C

Tab. 2.5.

## 2.5 - ADDRESSEES, SUPPLY AND STORAGE OF THE MANUAL

The instruction manual is intended for qualified technicians responsible for operating and managing the equipment throughout its service life.

It contains the necessary information to properly use the equipment and keep its functional and qualitative characteristics unchanged over time. All information and warnings for safe, correct use are also provided.

The manual, as well as the declaration of conformity and/or test certificate, is an integral part of the equipment and must always accompany it whenever it is moved or resold. It is the responsibility of the qualified professionals (see paragraph 2.10) to use and manage the equipment.

### **WARNING!**

**Removing, rewriting or editing the pages of the manual and their contents is not allowed.**

**PIETRO FIORENTINI S.p.A. shall not be held liable for any damage to people, animals and property caused by failure to adhere to the warnings and operating procedures described in this manual.**

## 2.6 - LANGUAGE

The original instruction manual was drawn up in Italian.

Any translations into additional languages are to be made from the original instruction manual.

### **HAZARD!**

**The translations into other languages cannot be fully verified. If any inconsistency is found, please refer to the text of the original manual.**



**If inconsistencies are found or the text does not make sense:**

- **stop any actions;**
- **immediately contact PIETRO FIORENTINI S.p.A. at the addresses specified in paragraph 2.1 (“Identification of the manufacturer”).**

### **WARNING!**

**PIETRO FIORENTINI S.p.A. shall be held liable for the information provided in the original manual only.**

## 2.7 - SYMBOLS USED IN THE MANUAL

Symbol	Definition
	Symbol used to identify important warnings for the safety of the operator and/or equipment.
	Symbol used to identify information of particular importance in the instruction manual. The information may also concern the safety of the personnel involved in using the equipment.
	Obligation to consult the instruction manual/booklet. Indicates a requirement for the personnel to refer to (and understand) the operating and warning instructions of the machine before working with or on it.

Tab. 2.6.

### HAZARD!

Alerts to a hazard with a high level of risk, an imminent hazardous situation which, if not prevented, will result in death or severe damage.

### WARNING!

Alerts to a hazard with a medium level of risk, a potentially hazardous situation which, if not prevented, may result in death or severe damage.

### ATTENTION!

Alerts to a hazard with a low level of risk, a potentially hazardous situation which, if not prevented, could result in minor or moderate damage.

### NOTICE!

Alerts to specific warnings, directions or notes of particular concern, that are not related to physical injury, as well as practices for which physical injury is not likely to occur.

## 2.8 - EQUIPMENT IDENTIFICATION

The equipment is equipped with identification silk screens.

The rating plates specify identification details of the equipment to be provided, if necessary, to PIETRO FIORENTINI S.p.A. At Tab. 2.7 the equipment identifier:

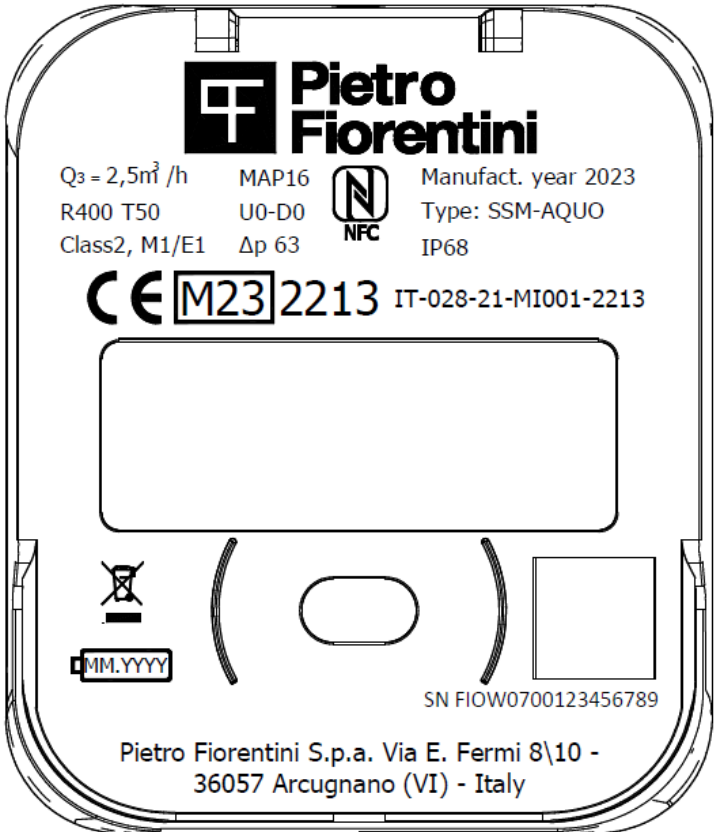
Id.	Type of plate	Image
1	Mod. SSM-AQUO	

Tab. 2.7.

### WARNING!

Removing nameplates and/or replacing them with other plates is strictly not allowed. Should the plates be unintentionally damaged or removed, the customer must notify **PIETRO FIORENTINI S.p.A.**

## 2.8.1 - IDENTIFIER OF THE LOGIC DEVICE

Term	Description
<b>Format</b>	FIO-W-07-ZV-YY-XXXXXX
<b>FIO</b>	Fixed field indicating the manufacturer (PIETRO FIORENTINI S.p.A.) according to the encoding of the Flag Association
<b>W</b>	Reserved
<b>07</b>	Device type (water meter)
<b>Z</b>	Measurement technology
<b>V</b>	Communication technology
<b>YY</b>	Year of manufacture
<b>XXXXXX</b>	Progressive number

Tab. 2.8.

### 2.8.1.1 - TYPE OF GAUGE

Code version "Z"	Measurement technology	DN
<b>0</b>	Ultrasonic smart meter Q3 ≤ 20	0=DN15&Q3=1.6 1=DN15&Q3=2.5 2=DN20&Q3=2.5 3=DN20&Q3=4 4=DN25&Q3=6 5=DN25&Q3=10 6=DN32&Q3=10 7=DN40&Q3=16

Tab. 2.9.

### 2.8.1.2 - REMOTE COMMUNICATION TYPE

Code "V" version	Type of communication	Model code
1	Wireless M-Bus & LoRaWAN	integrated
2	NB-IoT	integrated

Tab. 2.10.

### 2.8.2 - DESCRIPTION OF IDENTIFYING ELEMENTS

The information described in Tab. 2.11 can be found on the identification silkscreen:

Pos.	Description
1	Permanent flow rate Q3
2	Permanent flow rate Q3 / minimum flow rate Q1 ratio
3	Mechanical and electromagnetic accuracy grade and environmental class
4	"MID" Directive marking
5	Disposal guidelines (WEEE Directive 2012/19/EU)
6	Temperature Class
7	Flow profile sensitivity class indicator
8	Maximum permissible working pressure
9	Pressure drop class
10	Year of manufacture
11	Model code
12	EU Type Certificate Number
13	LCD display
14	Static smart meter series
15	Manufacturer's Logo
16	Identifier of the logic device (QR code)
17	Casing protection rating
18	Manufacturer's Address
19	Battery symbol: use within (month/year indicated)
20	NFC Antenna
21	Optical port/infrared

Tab. 2.11.



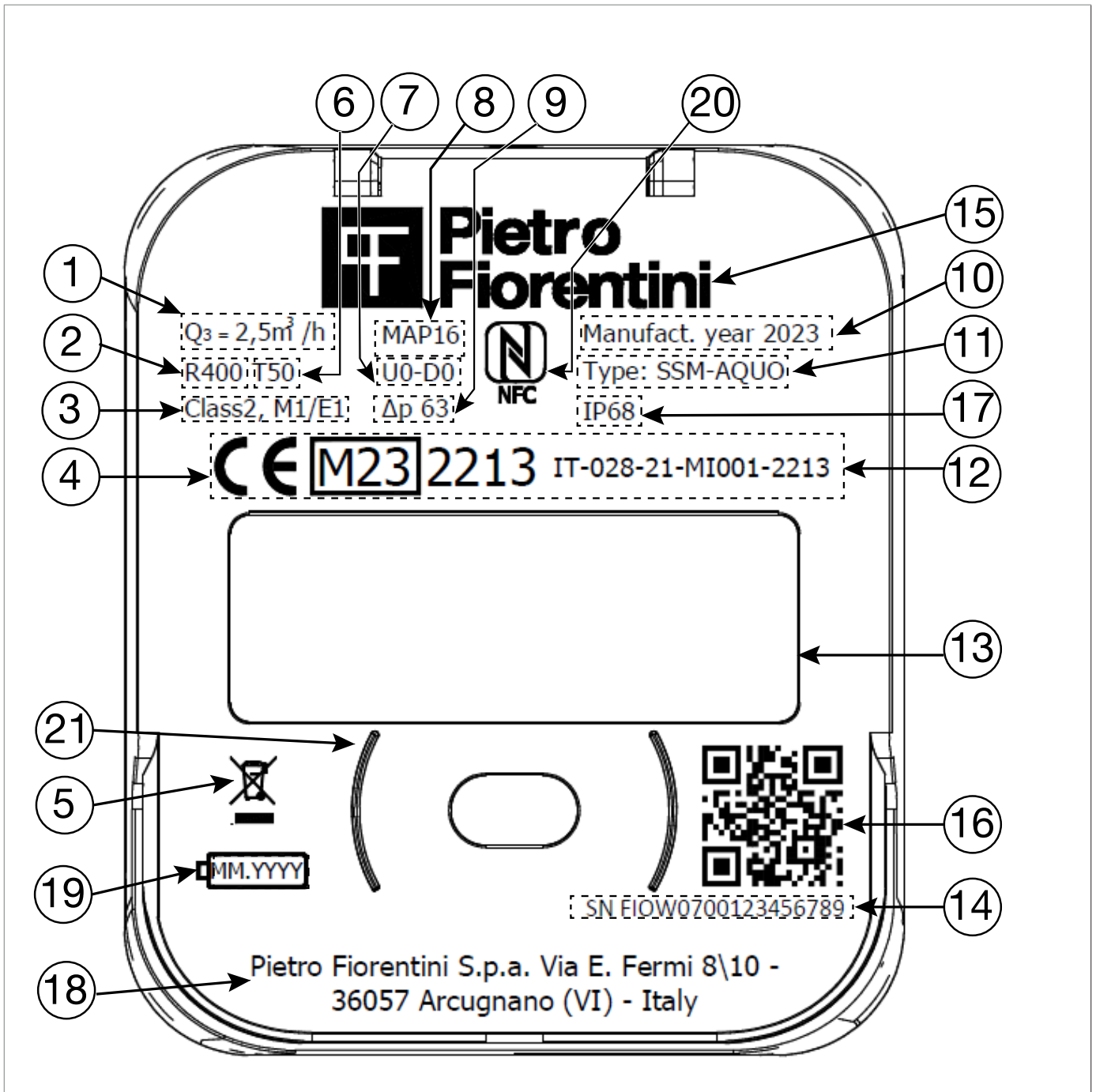

Fig. 2.1. Description of the nameplates

## 2.9 - GLOSSARY OF MEASUREMENT UNITS

Type of measurement	Unit of measurement	Description
<b>Consumption and Volumetric flow rate</b>	m <sup>3</sup>	Cubic metres
	L/h	Litres per hour
<b>Temperature</b>	°C	Degree centigrade

Tab. 2.12.

## 2.10 - QUALIFIED PROFESSIONAL FIGURES

Qualified operators in charge of using and managing the equipment throughout its technical service life to be used as indicated:

Professional figure	Definition
<b>Installer</b>	<p>Qualified operator able to:</p> <ul style="list-style-type: none"> <li>• handle materials and equipment.</li> <li>• carry out all the operations necessary to properly install the equipment;</li> <li>• perform all the operations necessary to safely operate the equipment and system;</li> <li>• be able to perform all the operations necessary to uninstall and subsequently dispose of the equipment in compliance with the regulations in force in the country of installation.</li> </ul>
<b>Specialised technician/ Maintenance technician</b>	<p>Trained and authorised technician on the management and use of the equipment, who must:</p> <ul style="list-style-type: none"> <li>• have proven experience in properly using the equipment similar to that described in this manual, and be trained, informed and instructed in this regard;</li> <li>• be able to perform all operations required for the proper functioning of the equipment and the system, and for their safety and that of any third parties present;</li> <li>• have access to all parts of the device for visual analysis, checking their condition.</li> </ul>

Tab. 2.13.

## 3 - SAFETY

### 3.1 - GENERAL SAFETY WARNINGS

#### **WARNING!**

- **It is strictly forbidden to repair or make any modifications to the equipment.**

#### **ATTENTION!**

**Authorised operators must not carry out operations or services on their own initiative that do not fall within their competence.**

**Never operate the equipment:**

- **while under the influence of intoxicating substances such as alcohol;**
- **if you are using drugs that may slow reaction times.**

#### **NOTICE!**

**The employer must train and inform operators on how to behave during operations and on the equipment to be used.**

Before installation, commissioning or maintenance, operators must:

- take note of the safety regulations applicable to the place of installation they are working in;
- obtain the necessary permits to operate when required;
- wear the personal protective equipment required by the procedures described in this instruction manual;
- ensure that the required collective protective equipment and safety information are available in the area they are operating in.

#### 3.1.1 - CONNECTING TO OTHER DEVICES

There is no permanent connection to external equipment. The SSM-AQUO appliance can connect to other devices. SSM-AQUO can connect locally via the NFC antenna and/or optical port to command data communication devices useful for device configuration.

SSM-AQUO can connect using the radio interface integrated to remote systems for data communication and management of commands useful for the configuration of the device.

#### 3.1.2 - POWER SUPPLY DEVICES

SSM-AQUO can only be powered by the specific battery pack approved with the device; using other power sources is prohibited.

The device uses a single battery pack to manage the metrology part, the local interfaces and the remote communication part. The battery pack is not field-replaceable.

The pack consists of a lithium battery with cables ending with a specific connector, enclosed in a protective sheath.

### 3.1.3 - SAFETY INSTRUCTIONS FOR INSTALLATION

This device must be installed and operated in compliance with the provisions and regulations in force.

#### NOTICE!

**PIETRO FIORENTINI S.p.A. shall not be liable for damage resulting from failure to comply with the instructions and from misuse.**

#### Safety warnings

All operations on the device must be performed by properly trained personnel.

#### Transformation and spare parts

Any technical changes are forbidden. Use only original spare parts intended by PIETRO FIORENTINI S.p.A.

#### Transport

As a rule, SSM-AQUO must be transported in a horizontal position and inside the original packaging box provided by PIETRO FIORENTINI S.p.A.

Upon receipt of the device, examine the supplied material.

Immediately report any shipping damage.

#### Storage

As a rule, SSM-AQUO must be stored in a horizontal position and in a dry place at room temperature (refer to paragraph 6.6.1).

#### WARNING!









- **During installation, avoid mechanical stress to the inlet and outlet connections.**
- **It is strictly forbidden to repair or make any modifications to the device.**
- **The installation, removal, and any operations must be performed by qualified personnel, in compliance with the provisions in force concerning safety.**

### 3.2 - PERSONAL PROTECTIVE EQUIPMENT

The following table shows the Personal Protective Equipment (PPE) and its description; an obligation is associated with each symbol.

Personal protective equipment means any equipment intended to be worn by the worker in order to protect them against one or several risks that are likely to threaten their safety or health during work.

For the operators in charge, depending on the type of work requested, the most appropriate PPE from those reported in Tab. 3.14 must be used:

Symbol	Meaning
	<b>Obligation to use safety or insulated gloves.</b> Indicates a requirement for the personnel to use safety or insulated gloves.
	<b>Obligation to use safety goggles.</b> Indicates a requirement for personnel to use protective goggles for eye protection.
	<b>Obligation to use safety shoes.</b> Indicates a requirement for the personnel to use accident-prevention safety shoes.
	<b>Obligation to use noise protection equipment.</b> Indicates a requirement for the personnel to use ear muffs or ear plugs to protect their hearing.
	<b>Obligation to wear protective clothing.</b> Indicates a requirement for the personnel to wear specific protective clothing.
	<b>Obligation to use a protective mask.</b> Indicates a requirement for the personnel to use respiratory masks in the event of a chemical risk.
	<b>Obligation to use a protective helmet.</b> Indicates a requirement for the personnel to use protective helmets.
	<b>Obligation to wear high visibility vests.</b> Indicates a requirement for the personnel to use high visibility vests.

Tab. 3.14.

 **WARNING!**

Each licensed operator is obliged to:

- **take care of his/her own health and safety and that of other people in the workplace who are affected by his/her actions or omissions, in accordance with the training, instructions and equipment provided by the employer;**
- **appropriately use the PPE made available;**
- **immediately report to the employer, the manager or the person in charge any deficiencies in the equipment and devices, as well as any dangerous conditions they may become aware of.**

### 3.3 - OBLIGATIONS AND PROHIBITIONS

The following is a list of obligations and prohibitions to be observed for the safety of the operator.

It is mandatory to:

- carefully read and understand the use, maintenance and warning manual;
- before installing the equipment, strictly refer to the details specified on the nameplates and in the manual;
- avoid knocks and violent impact that could damage the equipment.

It is forbidden to:

- operate in various capacities on the equipment without the PPE indicated in the work procedures described in this manual;
- operate in the presence of open flames or bring open flames close to the work area;
- use the equipment with parameters other than those indicated on the nameplate;
- use the equipment outside the operating temperature range declared on the identification plate and indicated in this manual;
- install or use the equipment in environments other than those specified in this manual.

### 3.4 - RESIDUAL RISKS

The equipment does not present residual risks for the operator related to its normal operation.

 **WARNING!**

**If there are any functional faults, do not operate.**

**Immediately contact PIETRO FIORENTINI S.p.A. for the necessary directions.**

 **WARNING!**

**It is mandatory to implement protective measures against electrostatic discharges during installation, configuration and maintenance of the equipment.**

The authorised operator must proceed as follows, during the various operational phases, to avoid the risk:

Operational phases	Obligations of the operator
<b>Installation</b>	<ul style="list-style-type: none"> <li>• Wear professional safety footwear with ESD characteristics</li> <li>• Wear work clothes that dissipate electrostatic charges</li> </ul>
<b>Configuration</b>	<ul style="list-style-type: none"> <li>• Wear professional safety footwear with ESD characteristics</li> <li>• Wear work clothes that dissipate electrostatic charges</li> </ul>
<b>Maintenance</b>	<ul style="list-style-type: none"> <li>• Wear professional safety footwear with ESD characteristics</li> <li>• Wear work clothes that dissipate electrostatic charges</li> </ul>

Tab. 3.15.

### 3.5 - SAFETY AND FRAUD PREVENTION

The solutions implemented on the equipment to assure safety comply with the requirements set forth by the reference standard in force. In detail, access:

- to the electronics is not possible without removing the mechanical metrological seals and without causing permanent damage to the metrological cover, in accordance with that described in the legalisation plan indicated in the type examination certificate (MID) of the meter;
- to the memory device is not possible without permanently and patently damaging the equipment;
- to the (non-replaceable) battery pack is not possible without removing the mechanical metrological seal, without permanent damage to the metrological cover, and without leaving a trace of the event in the device's memory log (event log and diagnostics, historicised and transmitted via radio).

The attempts:

- to tamper with the correct operation of the meter are intercepted and recorded in the Event Log and diagnostics, historicised and transmitted via radio;
- by unauthorised personnel to access the meter through the communication channels which it is equipped with are detected and recorded in the Events Log;
- to access the meter via communication channels using incorrect passwords or encryption keys are intercepted and recorded in the Event Log.

#### NOTICE!

- **The interface equipment usually available to the user can only be used to read the data and it is not possible to perform any configuration;**
- **The configurations that can be performed through the communication channels which the device is equipped with – which can only be carried out by authorised personnel – leave a track since they are stored in the appropriate memory log (Metrological Events Log).**



Furthermore:

- the commands sent by external devices through the communication channels which the device is equipped with are verified in terms of source authenticity;
- the messages transmitted through the communication channels conveying sensitive information are all efficiently encrypted;
- the duration of the conditions is monitored and recorded by the firmware.



### 3.6 - SAFETY PICTOGRAMS

The equipment and/or packaging PIETRO FIORENTINI S.p.A. good bear the safety pictograms described in Tab. 3.16:

Symbol	Definition
	Symbol used to identify a GENERIC HAZARD.
	Symbol applied to the packaging to identify the type of danger and risks related to the transported product, based on the classification of the European ADR agreement. Class 9 (Various dangerous substances). ADR - UN3090 (lithium metal batteries).
	The symbol indicates that the product must not be disposed of as unsorted waste but must be sent to separate collection facilities for recovery and recycling (WEEE Directive 2012/19/EU on waste electrical and electronic equipment - WEEE)

Tab. 3.16.

#### WARNING!

**It is absolutely forbidden to remove or alter the safety pictograms on the equipment or the packaging.**

### 3.7 - NOISE LEVEL

SSM-AQUO is a static meter and has no moving parts.

For the value of the noise generated by the equipment and further information, contact PIETRO FIORENTINI S.p.A.

#### ATTENTION!

**The obligation to use earmuffs or ear plugs to protect the hearing of qualified professional figures (reference paragraph 2.10) remains in the event that the noise in the installation environment of the equipment (depending on specific operating conditions) exceeds the value of 85 dBA.**



## 4 - DESCRIPTION AND OPERATION

### 4.1 - GENERAL DESCRIPTION

SSM-AQUO ultrasonic water meters are designed to measure, store and display the volume of water passing through the measuring section, in accordance with Directive 2014/32/EU of the European Parliament and of the Council on the harmonisation of the laws of the Member States relating to the making available on the market of measuring instruments (implemented in the Italian Republic by Government Decree no. Legislative Decree 84/2016, as amended).

The SSM-AQUO water meters consist of a brass body with threaded connections, a pair of ultrasonic transducers and the electronic display device.

The electronic display device itself consists of an LCD display showing the volume log, diagnostics and alarms. The meters are also equipped with an integrated radio module, W-Mbus, LoRaWAN and/or NB-IoT and NFC and ZVEI local reading peripherals.

The main elements of the equipment are (see Fig. 4.2):

Pos.	Description	Pos.	Description
1	Upper cover	6	Li-SOCI2 battery
2	Tamper-proof cover	7	Electronic board*
3	Metrological seal	8	Threaded fittings
4	External Enclosure	9	Input filter
5	Front cover		

\* Detail not visible in figure

Tab. 4.17.

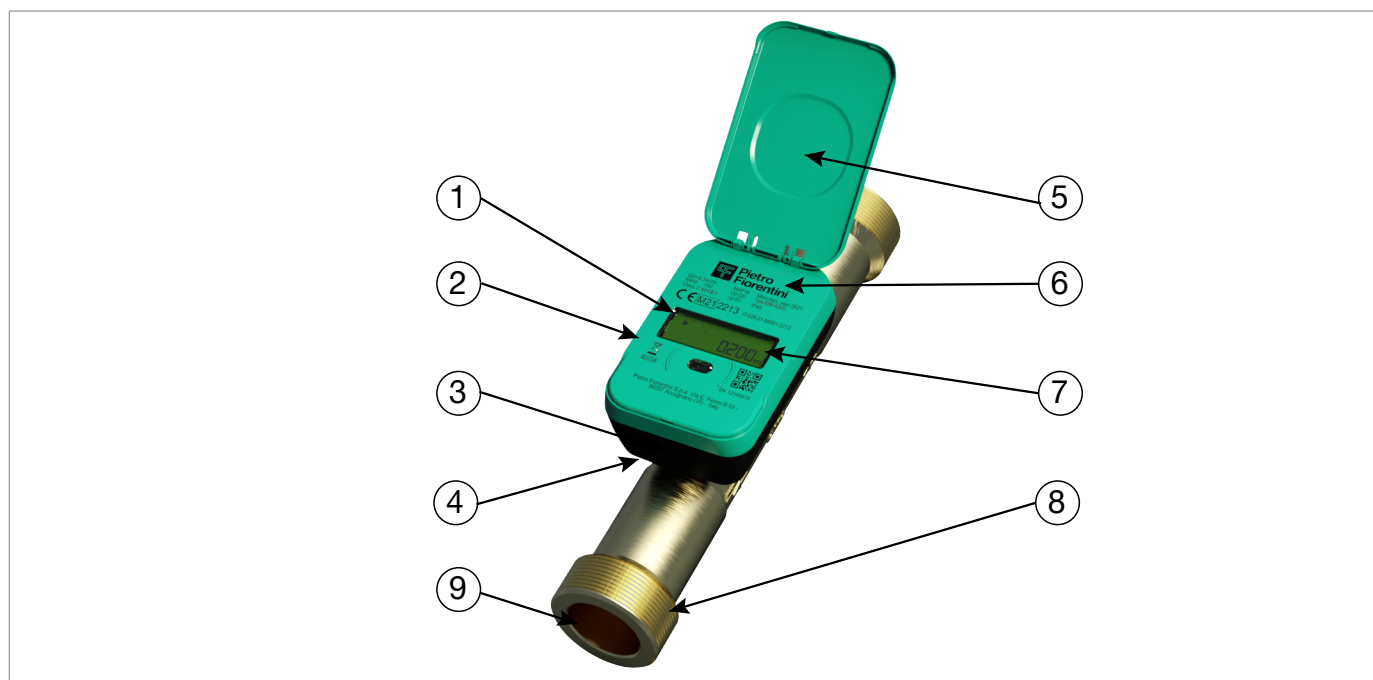

Fig. 4.2. General description SSM-AQUO

#### 4.1.1 - POWER SUPPLY DEVICES

The equipment SSM-AQUO can only be powered by the specific approved battery packs.  
The device uses a single battery pack for management:

- of the metrology part and local interfaces;
- of the W-Mbus, LoRaWAN and/or NB-IoT remote communication part.

##### **NOTICE!**

**For the technical details of the battery pack and the reference operating conditions, refer to paragraph 4.3 “Technical data”.**

#### 4.1.1.1 - CONNECTION OF THE POWER SUPPLY DEVICES

##### **NOTICE!**

**The SSM-AQUO device is supplied with the battery pack already connected and ready for use in the field.**

#### 4.1.1.2 - POWER SUPPLY STATUS

A calculation is made of the actual consumption, based on:

- the elapsed time;
- the individual functions actually performed (e.g. display, local and remote data transmission, etc.);
- the weight in terms of consumption defined for every specific function in the laboratory tests carried out by the Manufacturer;

When the critical charge point is reached (approx. 10% residual charge) an alarm is recorded. This alarm is shown on the display as a fixed icon and transmitted by radio.

### 4.1.2 - ACQUISITION OF THE MEASURE

The flow of water volumes (flow rate) is measured continuously by means of specific sensors, connected to the calculation board via an electrical connection.

The governing microprocessor:

- pilots the detection of the flow rate and temperature sensors;
- carries out continuous diagnostic activity to highlight any failures and fraud attempts.

### 4.1.3 - EVENTS AND DIAGNOSTICS

The equipment implements the anomaly detection and warning service (referenced).

### 4.1.4 - ACTIVATION AND CONFIGURATION

The equipment implements the following services in particular:

- synchronisation;
- software upgrade;
- functional requirements - programming;
- functional requirements - field start-up operations;
- functional requirements - clock.

### 4.1.5 - COMMUNICATION INTERFACES

The equipment has two communication interfaces, a local one and a remote one:

Interface	Type	Description
Local	Optical port/infrared	Requires an external device (optical probe) for connection to a local terminal/PC (compliant with IEC 62056-21).  The physical protocol used for the optical port is of HDLC type. The asynchronous format and the speed of the optical port are set to the following values: <ul style="list-style-type: none"> <li>• speed: 9600 baud;</li> <li>• data format: 8 (start bit), 1 (data bit), N (no parity), 1 (stop bit).</li> </ul> The optical port is normally switched off. An NFC scan is required to activate.
	NFC	Requires an external device (NFC antenna) to connect to a local terminal/PC (ISO 15693 compliance). <ul style="list-style-type: none"> <li>• speed: 9600 baud;</li> </ul> The NFC port is normally deactivated. An NFC scan is required to activate.
Remote	Wireless M-bus	Remote data transmission in walk-by / drive-by mode
	LoRaWAN - LPWAN	Long-range, low-bitrate remote data transmission
	NB-IoT	Long-range remote data transmission

Tab. 4.18.

## 4.1.6 - USER INTERFACE



Refer to chapter 5 in this manual for all information on the user interface.

## 4.2 - INTENDED USE

### 4.2.1 - ENVISAGED USE

The equipment in question is intended for:

Operation	Permitted	Unpermitted	Work environment
Measurement of water volume		Any other type of carrier other than permitted.	Application in end redelivery points of the water networks used: <ul style="list-style-type: none"> <li>residential;</li> <li>commercial.</li> </ul>

Tab. 4.19.

The equipment referred to was designed to be used exclusively within the limits specified on the nameplate and according to the instructions and limits of use specified in this manual.

Safe work conditions are as follows:

- use within the limits stated on the nameplate and in this manual;
- compliance with the user manual procedures.

### 4.2.2 - REASONABLY FORESEEABLE MISUSE

Incorrect and reasonably foreseeable misuse means the use of the equipment in a way not foreseen in the phase but which can result from result predictable human behaviour:

- using the equipment in a manner other than that referred to under “**Intended use**”.
- instinctive reaction of an operator in the event of a malfunction, accident or breakdown while using the equipment;
- behaviour resulting from carelessness;
- behaviour resulting from the use of the equipment by unauthorised and unsuitable people (children, disabled);

Any use of the equipment other than the intended use must be previously approved in writing by PIETRO FIORENTINI S.p.A. If no written approval is provided, use shall be considered “**improper**”.

In the event of “improper use”, PIETRO FIORENTINI S.p.A. shall not be held liable for any damage caused to people or property, and any type of warranty on the equipment shall be deemed void.

### 4.3 - TECHNICAL DATA

General features	
Electronic casing	Polycarbonate
Enclosure size	Alloy brass CW617N-DW, according to EN 12165
Casing protection rating	IP68
Maximum working pressure	16 bar
Operating temperature range	-25° C + 55° C
Water temperature range	+0.1° C + 50° C
Storage temperature range	-25°C + 55° C
Real time clock	Accuracy according to EN62054-21
Measurement precision	Class 2
Connections	<ul style="list-style-type: none"> <li>• DN15 &gt; 3/4" G, 7/8" G or 1" G (according to EN ISO 228-1)</li> <li>• DN20 &gt; 1" G (according to EN ISO 228-1)</li> <li>• DN25 &gt; 1 1/4" G (according to EN ISO 228-1)</li> <li>• DN32 &gt; 1 1/2" G (according to EN ISO 228-1)</li> <li>• DN40 &gt; 2" G (according to EN ISO 228-1)</li> </ul>
Rangeability	up to R500 (high accuracy, repeatability and no air measurement), according to ISO 4064, OIML R49, MID
Pressure drop	DN15-20 Δp63, DN25-40 Δp40
Mechanical/electromagnetic environment class	<ul style="list-style-type: none"> <li>• M1 fixed installation with minimal vibration</li> <li>• E1 residential, commercial and light industry</li> </ul>
Temperature Class	(T30) T50
Flow profile sensitivity classes	U0-D0
Sensitivity to installation	<ul style="list-style-type: none"> <li>• H/V</li> <li>• H</li> <li>• V</li> </ul>
Climatic and mechanical environments	<ul style="list-style-type: none"> <li>• B (indoor installation)</li> <li>• 0 (outdoor installation)</li> </ul>

Tab. 4.20.

Remote communication features	
W-MBus	T1/C1 f= 868,7 ÷ 869,2 MHz
LoRaWAN	Class A f= 863 ÷ 870 MHz
NB-IoT	<ul style="list-style-type: none"> <li>• Multi-band LTE Cat-NB2</li> <li>• 3GPP Rel. 14</li> <li>• B3/B20</li> </ul>

Tab. 4.21.

Battery features	
Metrology and communication battery pack	Type: Non-rechargeable battery Li-SOCl <sub>2</sub> 3,6V, Size C Autonomy: Size C ≥ 13 years

Tab. 4.22.





## 5 - USER INTERFACE

### 5.1 - GENERAL DESCRIPTION

The following paragraphs describe the interaction methods between operator and user interface, and the meanings of the various fields on the display.

The user interface consists of the following main components, through which it is possible to consult the data provided by the device (see Fig.5.3.):

Pos.	Element	Description
1	LCD display black and white with segments	Allows you to consult the data provided by the equipment.

Tab. 5.23.

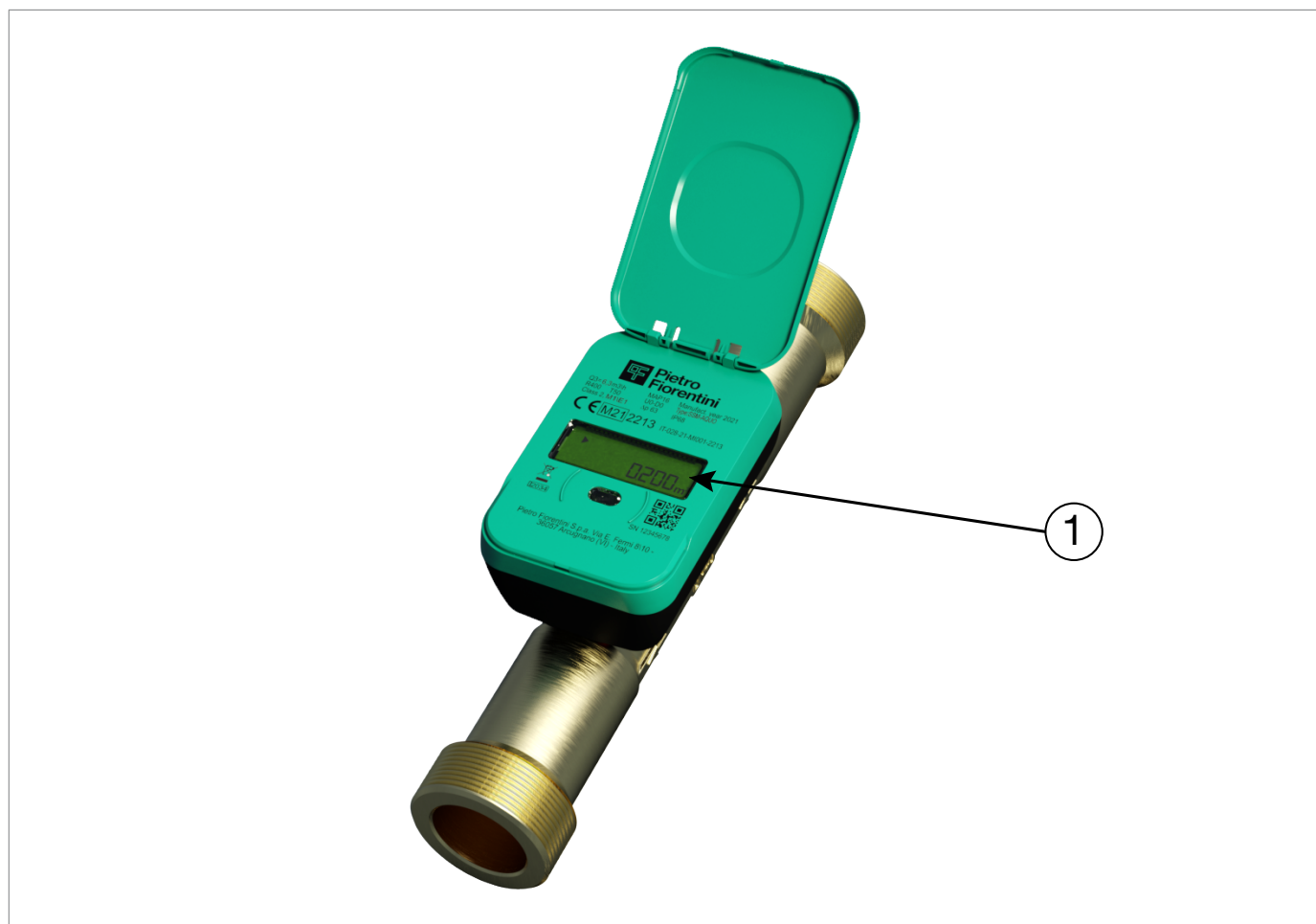

Fig. 5.3. User interface SSM-AQUO

## 5.2 - LCD DISPLAY DESCRIPTION

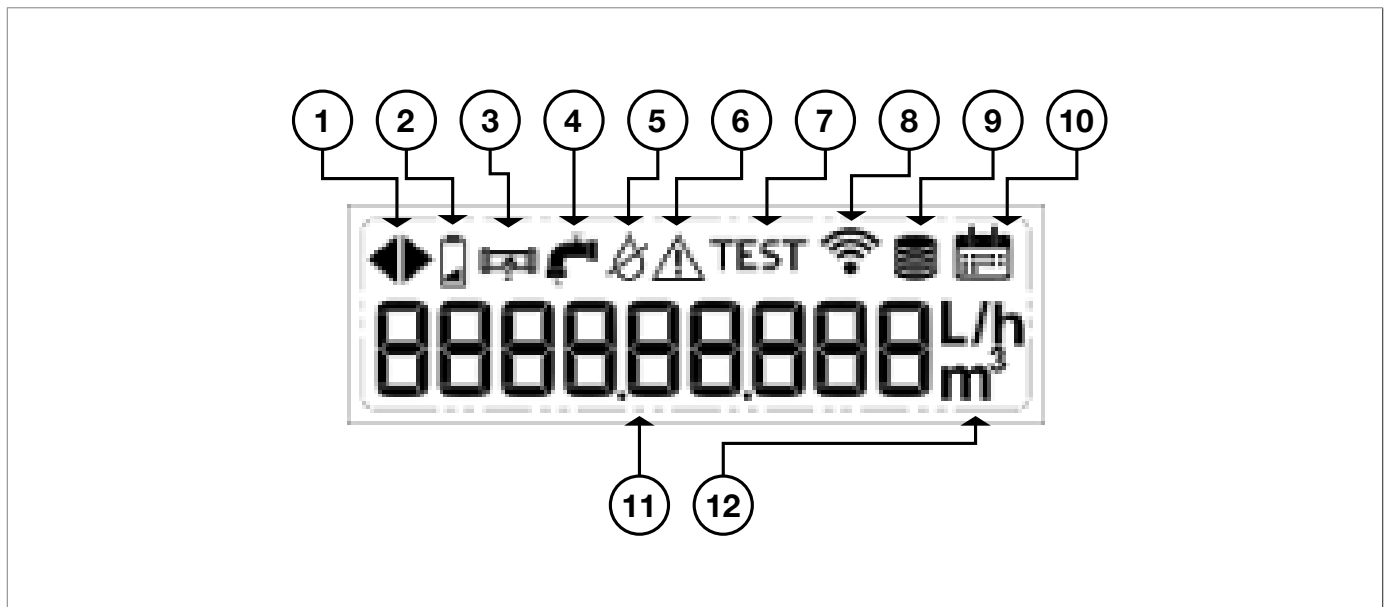

Fig. 5.4. LCD Display SSM-AQUO

Tab. 5.24 describes the main elements on the display (Fig. 5.4):

Pos.	Description
<b>ICONS FIELD</b>	
1	Flow direction: ▶ direct flow ◀ reverse flow
2	Low battery
3	Pipe rupture, sudden increase in water flow rate
4	Leak detection, continuous water flow
5	No water in the meter or partially empty pipe
6	Attempted fraud
7	Test mode active
8	Active communication module
9	Configured EOB data storage (absolute totaliser)
10	Configured EOB data storage (date)
11	Volume
12	Unit of measurement

Tab. 5.24.





### 5.3 - NAVIGATION PROCEDURE

The SSM-AQUO equipment display is always on. There are no navigation buttons, and the menu displays data cyclically according to the manufacturer's predefined schedule indicated in Tab. 5.25.

The display can be customised by extending the menu from the manufacturer via the NFC interface.

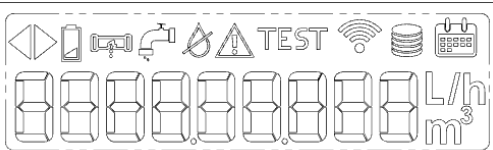
#### 5.3.1 - SEQUENCE OF AVAILABLE MENUS

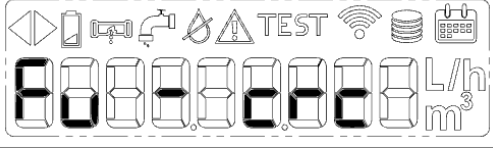
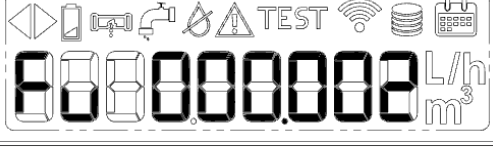

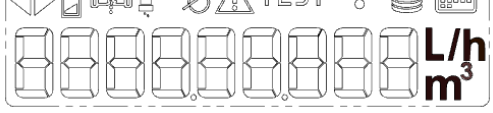

The display cyclically shows the information as described in Tab. 5.25.

Visualisation	Description	Display time
	Display segments off	3 seconds
	Display segments check A test sequence is displayed to check for faulty segments or icons (all segments and icons lit at the same time)	3 seconds
	Totaliser (Units of measurement range: m <sup>3</sup> )	60 seconds
	Fu Firmware Version: xxx.yyy XXX -> Application YYY -> Radio	3 seconds
	CRC Firmware	3 seconds
	Application firmware checksum	3 seconds
	Radio firmware checksum	3 seconds
	Unit of measurement L/h - Flow rate m <sup>3</sup> - Totaliser	-

Tab. 5.25

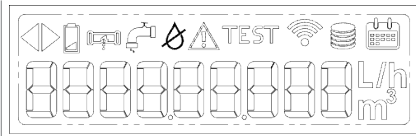
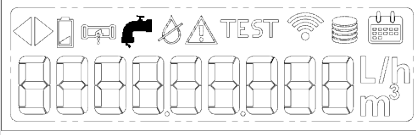
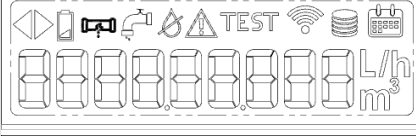
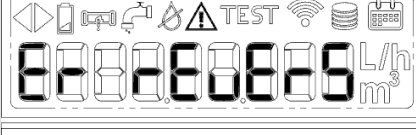
### 5.3.2 - ALARMS

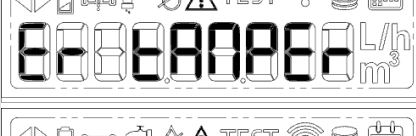
Tab. 5.26 indicates the sequence for the following display during the chapter selection phase:

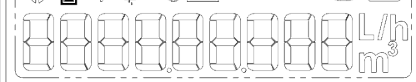
Field shown on display	How much is activated	How much is deactivated
	Empty pipe: no water in the pipe	Presence of water in the pipe, automatically reset
	Leakage: detects continuous flow of $>0.5 \cdot Q1$ for 12 hours (*)	When the flow is interrupted, it is automatically reset
	Burst: flow rate above $Q3$ detected for 30 consecutive minutes	When the flow decreases for at least 1 minute below $0.5 \cdot Q1$ , it is automatically reset
	Incorrect installation: meter starts detecting flow in the opposite direction ( $> 8l$ )	When flow is detected is in the correct direction, it is automatically reset
	Reverse flow: detected continuous flow of more than 20 litres in the opposite direction (*)	Reset by authorised personnel (via NFC and/or remote control)
	Maximum flow rate exceeded: flow rate higher than $Q4$ for 10 consecutive minutes	Reset by authorised personnel (via NFC and/or remote control)
	Tamper (electronic fraud): opening of the plastic container detected	Replace
	Frozen pipe: water temperature below $0.5 \text{ °C}$ (1h consecutive)	Reset by authorised personnel (via NFC and/or remote control)
	Low battery level	Replace

(\*) configurable thresholds

Tab. 5.26

## 5.4 - DATA LOGGER

The line of SSM-AQUO ultrasonic smart water meters has data storage memory with FIFO logic. The recorded values (refer to the 'Variable' column of Tab. 5.27) are stored:

- each hour ('Hourly data')
- at midnight ('Daily Data')
- last day of the month ('Monthly data')
- last day of the year ('Annual Data')

The data in Tab. 5.27 are saved and made available via NFC according to the storage memory:

Data Logging	Variable	Filing memory	Recycling
Hourly data	<ul style="list-style-type: none"> <li>• Date and time</li> <li>• Active diagnostics</li> <li>• Total volume</li> </ul>	72 hours	NFC reading The storage data are all made available even in the event of LCD malfunction or meter failure, through reading via NFC
Daily data	<ul style="list-style-type: none"> <li>• Forward volume</li> <li>• Backward volume</li> <li>• Maximum capacity</li> <li>• Minimum flow rate</li> </ul>	60 days	
Monthly data	<ul style="list-style-type: none"> <li>• Maximum water temperature</li> <li>• Minimum water temperature</li> <li>• Average water temperature</li> </ul>	15 months	
Annual data	<ul style="list-style-type: none"> <li>• Maximum ambient temperature</li> <li>• Minimum ambient temperature</li> <li>• Average ambient temperature</li> </ul>	18 years	

Tab. 5.27

## 5.5 - RADIO TRANSMITTED PAYLOAD

Transmission	Protocol	Typical calendar	Transmission window	Power output	Data transmitted
W-Mbus	Unidirectional	1 tx each 60 seconds	08.00 - 18.00	14dBm	<ul style="list-style-type: none"> <li>• Absolute totaliser</li> <li>• Date and time</li> <li>• Alarms (par. 5.3.2)</li> <li>• Reverse flow totaliser</li> <li>• Actual water temperature</li> <li>• Two historical registers (EOB) and related data</li> <li>• Previous historical records (12 months)</li> <li>• Battery percentage</li> </ul>

Transmission	Protocol	Typical calendar	Transmission window	Power output	Data transmitted
LoRaWAN	Two-way	2 tx per day	Random in the 24 hours	14dBm	<ul style="list-style-type: none"> <li>• Absolute totaliser</li> <li>• Date and time</li> <li>• Alarms (par. 5.3.2)</li> <li>• Recorded volumes (in litres) - midnight (24:00)</li> <li>• Recorded reverse volumes (in litres) - midnight (24:00)</li> <li>• Min/max water temperature</li> <li>• Battery charge percentage</li> <li>• Hourly consumption (referring to the previous day)</li> </ul>
NB-IoT	Two-way	1 tx per day	Random in the 24 hours	23dBm	<ul style="list-style-type: none"> <li>• Absolute totaliser</li> <li>• Date and time</li> <li>• Alarms (par. 5.3.2)</li> <li>• Recorded volumes (in litres) - midnight (24:00)</li> <li>• Recorded reverse volumes (in litres) - midnight (24:00)</li> <li>• Min/max water temperature</li> <li>• Battery charge percentage</li> <li>• Hourly consumption (referring to the previous day)</li> </ul>

Tab. 5.28

## 6 - TRANSPORT AND HANDLING





### 6.1 - SPECIFIC WARNINGS FOR TRANSPORT AND HANDLING

#### NOTICE!

Transport and handling must be carried out in compliance with the regulations in force in the country of installation by personnel who are:

- qualified (specially trained);
- who are familiar with accident prevention and workplace safety regulations;
- authorised to use lifting equipment.

#### Transport and handling

Operator qualification	<ul style="list-style-type: none"> <li>• Installer.</li> </ul>
PPE required	<div style="display: flex; align-items: center;">     </div> <div style="background-color: #f4a460; padding: 5px; margin-top: 5px;">  <b>WARNING!</b> </div> <p>The PPE listed in this table is related to the risk associated with the equipment. For the PPE required to protect against risks associated with the workplace, installation or operating conditions, please refer to:</p> <ul style="list-style-type: none"> <li>• the regulations in force in the country of installation;</li> <li>• <u>any information provided by the Safety Manager at the installation facility.</u></li> </ul>
Weights and dimensions of the equipment	For dimensions and weights please refer to “6.3 - Physical characteristics of the equipment”.

Tab. 6.29.

### 6.1.1 - PACKAGING AND FASTENERS USED FOR TRANSPORT

The transport packaging is designed and manufactured to avoid damage during normal transport, storage and handling. The equipment must be kept in the packaging until installation.

Upon receiving the equipment, please:

- make sure that no part has been damaged during transport and/or handling;
- immediately report any damage found to PIETRO FIORENTINI S.p.A..

#### **NOTICE!**

**PIETRO FIORENTINI S.p.A. shall not be liable for any damage to people or property caused by accidents due to failure to comply with the instructions provided in this manual.**

Tab. 6.30 describes the types of packaging used:

Ref.	Type of packaging	Image
A	Single cardboard box	

Tab. 6.30.

#### **NOTICE!**

The packages are labelled in accordance with ADR, i.e. with a diamond shape on the side and code UN3090.



### 6.2 - PACKAGING CONTENT

The packaging contains:

#### Description of content

SSM-AQUO water meter including:

- no. 2 (two) system connection shanks (if indicated in the order);
- no. 2 (two) rubber gasket kits (if indicated in the order);
- no. 1 (one) Quick User Guide

#### **NOTICE!**

**The battery is already electrically connected inside the operating slot.**

Tab. 6.31.

#### **NOTICE!**

The use, maintenance and warning manual can be downloaded from the Manufacturer's website: <https://www.fiorentini.com>



## 6.3 - PHYSICAL CHARACTERISTICS OF THE EQUIPMENT

### 6.3.1 - SSM-AQUO

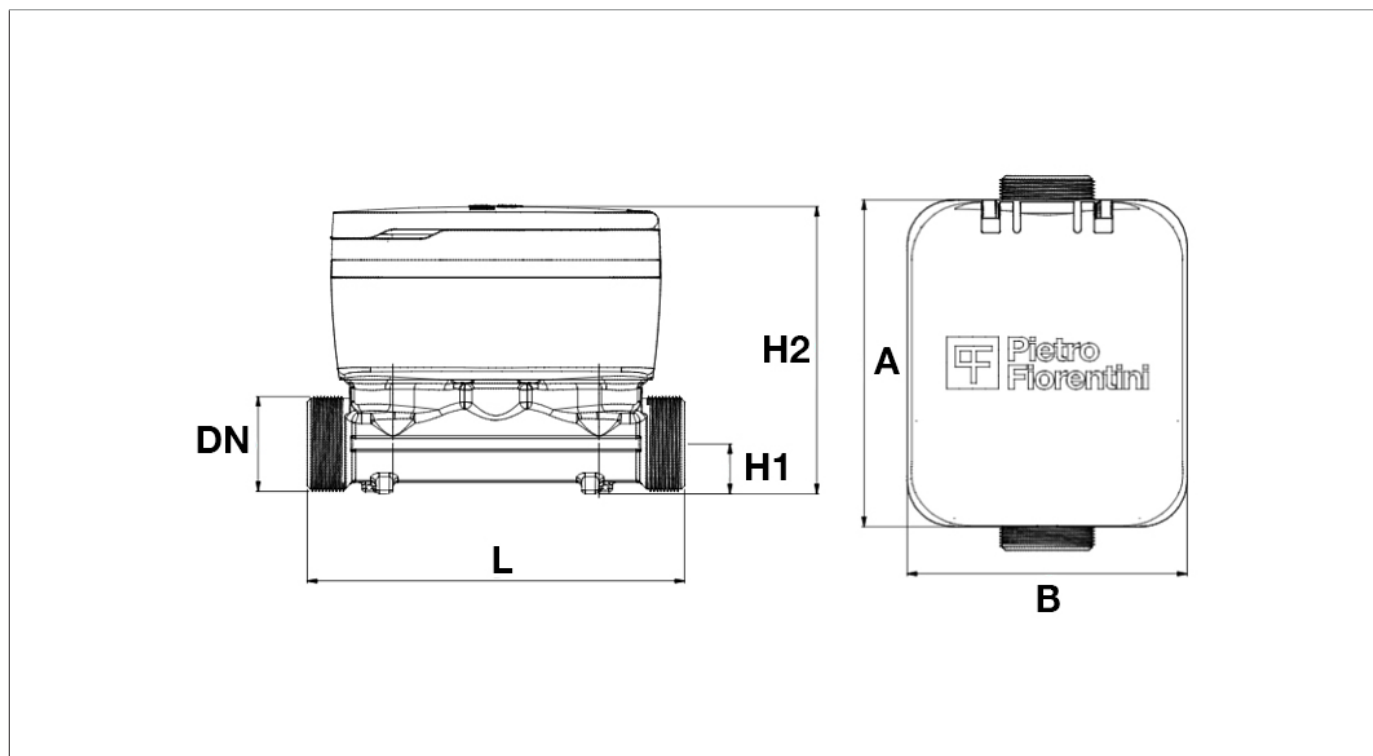

Fig. 6.5. Dimensions SSM-AQUO - brass version

Dimensions						
Nominal dimensions	DN (mm)	DN 15	DN 20	DN 25	DN 32	DN 40
	inches	1/2"	3/4"	1"	1" 1/4	1" 1/2
L (mm)		110-115	130-190	260	260	300
H1 (mm)		15	17.5	24	27	33
H2 (mm) versions:						
• LoRaWAN		84	88	98	103	112
• & W-mbus						
H2 (mm) NB-IoT version		112,6	112,6	126,6	131,6	140,6
A (mm)		96	96	121	121	121
B (mm)		82	82	82	82	82

Tab. 6.32.

Weight						
Nominal dimensions	DN (mm)	DN 15	DN 20	DN 25	DN 32	DN 40
	inches	1/2"	3/4"	1"	1" 1/4	1" 1/2
Weight (kg)		0.55	0.65	1.15	1,40	2,10

Tab. 6.33.

## 6.4 - EQUIPMENT ANCHORING AND LIFTING METHOD

### **HAZARD!**

Using lifting equipment (if necessary) for unloading, carrying and handling packages is reserved only for skilled operators who have been properly trained (and are appropriately qualified if required by the regulations in force in the country of installation) and are familiar with:

- accident prevention rules;
- workplace safety provisions;
- lifting equipment features and limits.

### **HAZARD!**

Before handling a load, make sure that its weight does not exceed the load capacity of the lifting equipment (and any other lifting tools) specified on the specific plate.

### **ATTENTION!**

Before moving the equipment:

- remove any movable or hanging component or firmly secure it to the load;
- protect fragile equipment;
- check that the load is stable;
- make sure to have perfect visibility along the route.

### 6.4.1 - FORKLIFT HANDLING METHOD

**HAZARD!**

It is forbidden to:

- Do not transit under suspended loads;
- Do not move the load over the personnel operating in the site/plant area.

**WARNING!**

The following is not allowed on forklifts:



- carrying passengers;
- lifting people.

**WARNING!**

During all handling operations, pay close attention to avoid impact or vibrations of the equipment batteries.

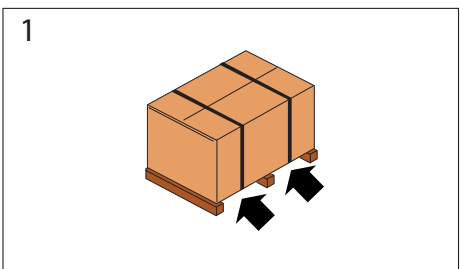
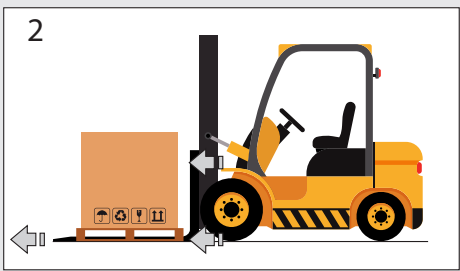
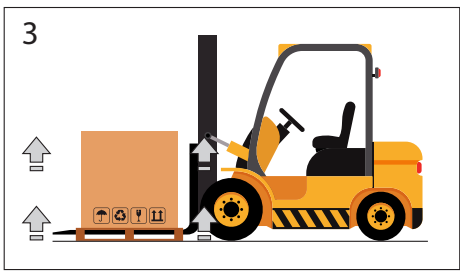
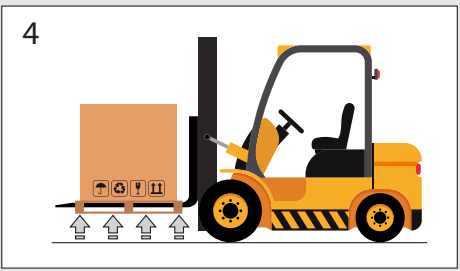
If cardboard boxes (single or multiple) are carried on a pallet, proceed as indicated in Tab. 6.34:

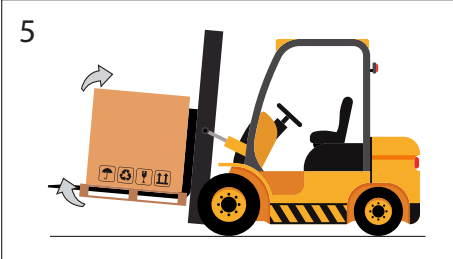
Step	Action	Image
1	Place the forks of the forklift under the load surface.	
2	Make sure that the forks protrude from the front of the load (by at least 5 cm), far enough to eliminate any risk of the transported load tipping.	
3	Raise the forks until they are touching the load. <b>NOTICE!</b> <b>Fasten the load to the forks with clamps or similar devices if required.</b>	
4	Slowly lift the load by a few dozen centimetres and check its stability, making sure that the centre of gravity of the load is at the centre of the lifting forks.	

Step	Action	Image
5	Tilt the mast backwards (towards the driver's seat) to help the over-turning moment and to ensure greater load stability during transport.	
6	Adjust transport speed according to the type of floor and load, avoiding sudden manoeuvres. <div style="background-color: #f4a460; padding: 5px; margin: 5px 0;">  <b>WARNING!</b> </div> <b>In case of:</b> <ul style="list-style-type: none"> <li>• <b>obstacles along the path;</b></li> <li>• <b>particular operating situations;</b></li> </ul> <b>hinder operator visibility, the assistance of a ground operator is required, standing outside the range of action of the lifting equipment,</b> <b><u>with the task of signalling.</u></b>	-
7	Place the load in the chosen installation area.	-

Tab. 6.34.

## 6.5 - PACKAGING REMOVAL

Packaging removal	
Operator qualification	<ul style="list-style-type: none"> <li>Installer.</li> </ul>
PPE required	<div style="display: flex; align-items: center;">  </div> <div style="background-color: #f4a460; padding: 5px; margin-top: 10px;"> <p><b>⚠ WARNING!</b></p> </div> <p>The PPE listed in this table is related to the risk associated with the equipment. For the PPE necessary to protect against risks associated with the workplace or operating conditions, please refer to:</p> <ul style="list-style-type: none"> <li>the regulations in force in the country of installation;</li> <li><u>any information provided by the Safety Manager at the installation facility.</u></li> </ul>

Tab. 6.35.

To unpack the cardboard boxes (single or multiple) supported by a pallet, proceed as described in Tab. 6.36:

Step	Action
1	Remove the stretch film around the pallet.
2	Remove the 4 support corners.
3	<p>Move the boxes of the equipment from the pallet to their intended place.</p> <div style="border: 1px solid #0070c0; padding: 5px; margin-top: 10px;"> <p><b>! NOTICE!</b></p> <p><b>Have at least 2 operators manually move the packages if required due to their dimensions/weight.</b></p> </div>

Tab. 6.36.

**! NOTICE!**

After removing all packaging materials, check for any anomalies.  
If there are anomalies:

- do not install the equipment;
- contact PIETRO FIORENTINI S.p.A. and specify the details provided on the equipment nameplate.

**⚠ WARNING!**

The single piece of equipment is contained in a specifically created cardboard box.  
Avoid taking the equipment out of the box before its installation.

### 6.5.1 - PACKAGING DISPOSAL

**! NOTICE!**

Sort the various materials making up the packaging and dispose of them in compliance with the regulations in force in the country of installation.

## 6.6 - STORAGE AND ENVIRONMENTAL CONDITIONS

### **WARNING!**

**Protect the equipment from blows and impacts, even accidental, until it is installed.**

### **NOTICE!**

**The meters must be stored in an upright position.**

If the equipment needs to be stored for an extended period, the minimum environmental conditions for the intended storage are provided in Tab. 6.37. Compliance with these conditions will guarantee the declared performance:

Conditions	Data
Maximum storage period	13 years product life cycle
Storage temperature	from -25°C to + 55°C
Relative humidity	95%

Tab. 6.37.

## 7 - INSTALLATION

### 7.1 - GENERAL WARNINGS

 **WARNING!**

The installation must be performed by qualified personnel, in compliance with the provisions in force concerning safety.

 **WARNING!**

For the safe use of the equipment, respect the permitted environmental conditions and comply with the data shown on the nameplate.

 **WARNING!**

It is strictly forbidden to make any modifications to the equipment.

 **WARNING!**

PIETRO FIORENTINI S.p.A. is not liable for damage caused by incorrect installation of the equipment and/or otherwise different from that indicated in this manual.

### 7.2 - INSTALLATION PRE-REQUISITES

#### 7.2.1 - ALLOWED ENVIRONMENTAL CONDITIONS

 **NOTICE!**

For details on the allowed environmental conditions (temperature range and classification) refer to paragraph "Technical data".

 **WARNING!**

PIETRO FIORENTINI S.p.A. is not liable for damage and/or malfunctions caused by installation in environments other than those permitted.

### 7.3 - CHECKS BEFORE INSTALLATION

The installation site must be suitable for the safe use of the equipment.

The equipment installation area must have lighting that guarantees the operator good visibility during the installation phases.

Before installation, it must be ensured that:

- the installation compartment meets the provisions in force on safety and is away from any possible damage of mechanical origin, away from sources of heat or naked flames, in a dry place and protected from external agents;
- the utilities on the customer side are closed;
- there are no impediments that could hinder the installer's installation operations;
- the upstream and downstream pipes are at the same level and can bear the weight of the equipment;
- there are no stresses on the connections;
- the inlet and outlet connections of the equipment are clean and have not been damaged;
- mechanical stresses on the inlet and outlet connections are totally absent.

Installation	
<b>Operator qualification</b>	<ul style="list-style-type: none"> <li>• Installer.</li> </ul>
<b>PPE required</b>	<div style="display: flex; align-items: center;">  </div> <div style="background-color: #f9a825; padding: 5px; margin-top: 5px;"> <p><b>⚠ WARNING!</b></p> <p>The PPE listed in this table is related to the risk associated with the equipment. For the PPE required to protect against risks associated with the workplace, installation or operating conditions, please refer to:</p> <ul style="list-style-type: none"> <li>• the regulations in force in the country of installation;</li> <li>• <u>any information provided by the Safety Manager at the installation facility.</u></li> </ul> </div>
<b>Equipment required</b>	Keys to fix inlet and outlet connections fittings/equipment.

Tab. 7.38.

### 7.4 - SPECIFIC SAFETY INSTRUCTIONS FOR THE INSTALLATION STEP

**⚠ NOTICE!**

The equipment is supplied with its battery packs already inserted and connected, therefore, once installed, it is ready for use.

**⚠ WARNING!**

Before proceeding with installation, make sure that the upstream and downstream valves installed on the line are shut off.

**⚠ WARNING!**

During the equipment installation:

- avoid mechanical stresses on its inlet/outlet connections;
- implement protective measures against electrostatic discharges.



## 7.5 - INSTALLATION REQUIREMENTS

### WARNING!

Check the correct alignment of upstream and downstream pipes

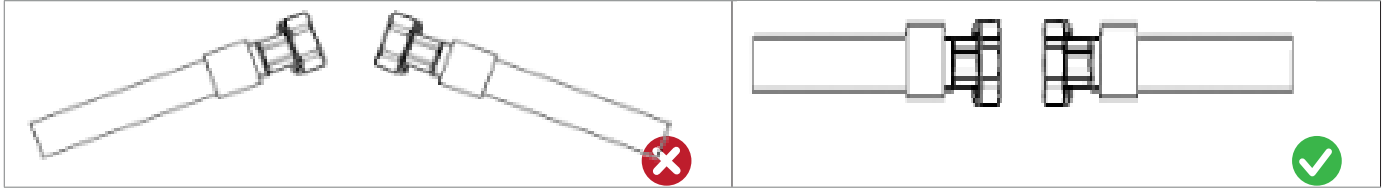

Fig. 7.6. Incorrect pipe alignment

Fig. 7.7. Correct pipe alignment

### WARNING!

Check the distance between couplings to avoid mechanical stress ( $U+D < 5 \text{ mm}$ )

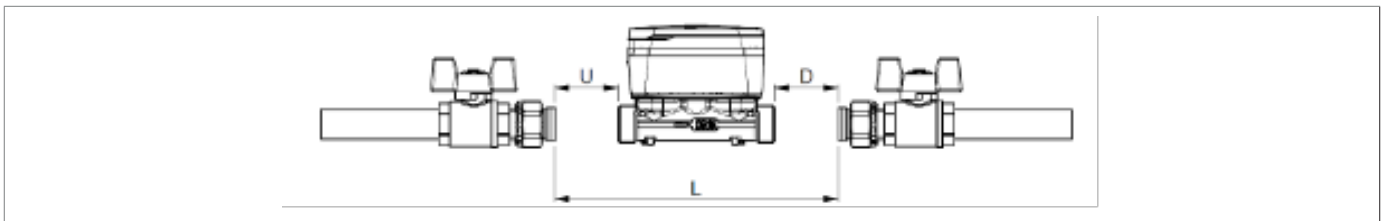

Fig. 7.8. Distance between SSM-AQUO meter and the joints

### NOTICE!

The equipment is class UOD0 and does not require a straight section before and after the meter.

### NOTICE!

The device can be installed in any position

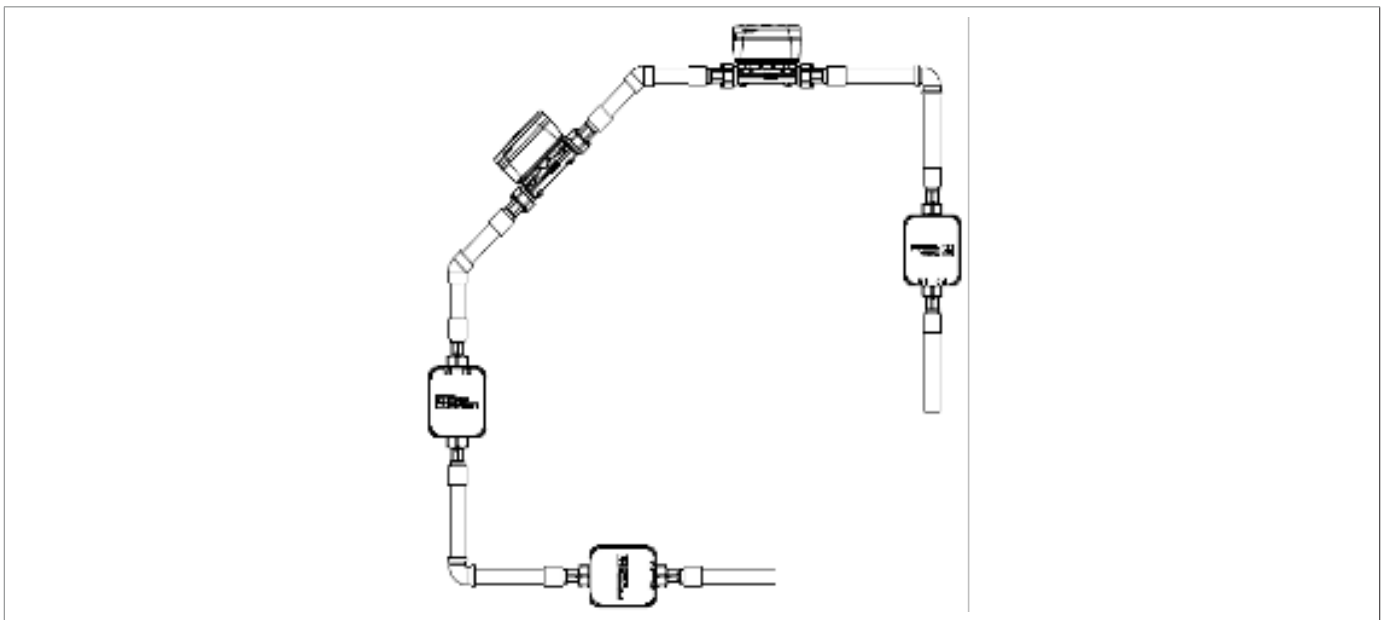

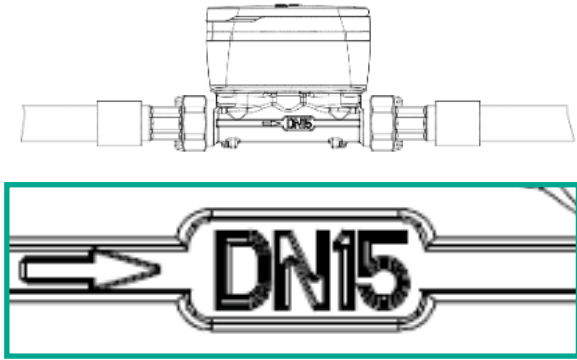

Fig. 7.9. Possible installation positions

## 7.6 - INSTALLATION PROCEDURE

To **install the meter (A)**, proceed as described at Tab. 7.39:

Step	Action
1	Remove any packaging or protection present
2	Install new gaskets in the pipe connections <div style="border: 1px solid blue; padding: 2px;">  <b>NOTICE!</b>  <b>Gaskets are not included in the meter package.</b> </div>
3	Position the meter in accordance with the flow direction indicated on the side of the meter <div style="text-align: center;">  </div>
4	Fasten the nuts according to the tightening torques indicated in the table Tab. 7.39
5	Open the upstream valve to allow water to flow into the meter
6	Open the downstream valve to allow air to escape from inside the pipeline
7	Close the downstream valve

Tab. 7.39.

 **NOTICE!**

**Check fittings for leaks**

## 7.7 - TIGHTENING TORQUES

When fastening the joints, follow the instructions in Tab. 7.40:

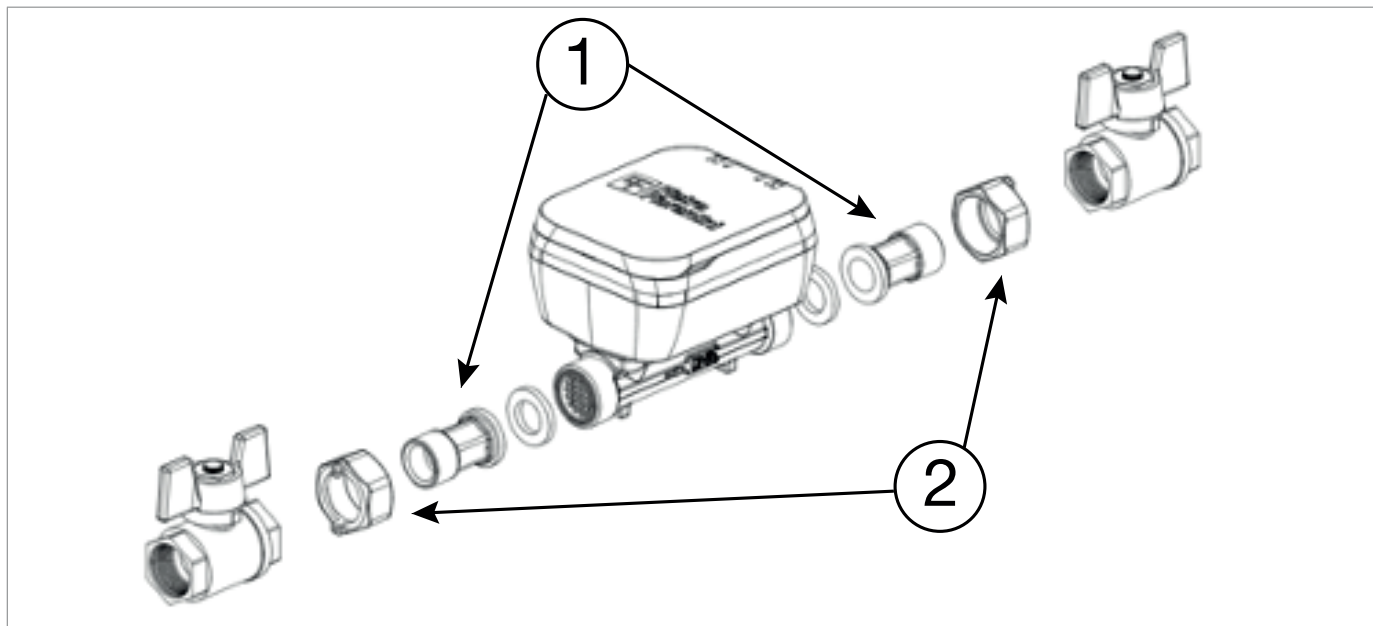

Fig. 7.10. Meter joints

DN	Key 1	Key 2	Tightening Torque (Nm)
15	17	29	30
20	23	36	35
25	30	46	35
32	36	53	40
40	44	66	45

Tab. 7.40.

## 7.8 - EQUIPMENT ADJUSTMENTS

### NOTICE!

The equipment is adjusted as required by the Customer, directly in the facility PIETRO FIORENTINI S.p.A.  
**No further adjustments are required.**



## 8 - CONFIGURATION

### 8.1 - SAFETY REQUIREMENTS FOR CONFIGURATION

Configuration	
Operator qualification	<ul style="list-style-type: none"> <li>Specialised technician.</li> <li>Installer.</li> </ul>
PPE required	 <p><b>WARNING!</b></p> <p>The PPE listed in this table is related to the risk associated with the equipment. For the PPE required to protect against risks associated with the workplace, installation or operating conditions, please refer to:</p> <ul style="list-style-type: none"> <li>the regulations in force in the country of installation;</li> <li><u>any information provided by the Safety Manager at the installation facility.</u></li> </ul>

Tab. 8.41.

### 8.2 - EQUIPMENT CONFIGURATION

#### NOTICE!

Equipment configuration must be carried out by authorised and qualified personnel.

#### NOTICE!

The field configuration of the device can be done from the local port or remotely by the CAS, again using the application protocol.

#### 8.2.1 - USING THE NFC DRIVER

Bring the reading device close to the top of the dial SSM-AQUO (above Display).

To activate communication with SSM-AQUO: approach the reader device and submit the access credentials defined in the order (installer profile and password).

Place the probe head in the appropriate slot on the front part of SSM-AQUO with the cable facing downwards. The slot will help the device to be put in place.

To activate communication on the optical port: bring an NFC tag close to the front of the meter and then remove the tag. This will enable the optical port.

To interrupt communication with the device: remove the reading device from the range of action.

### 8.3 - VERIFY CORRECT CONFIGURATION

The equipment is fully factory tested in accordance with the template shared with the water network operator at the time of ordering.

### 8.4 - CONNECTING TO OTHER DEVICES

There is no equipment connection SSM-AQUO with external devices.



## 9 - MAINTENANCE AND FUNCTIONAL CHECKS

### 9.1 - ROUTINE MAINTENANCE

 **NOTICE!**

There are no routine maintenance activities.

### 9.2 - SPECIAL MAINTENANCE

 **NOTICE!**

There are no special maintenance activities.





## 10 - UNINSTALLATION AND DISPOSAL

### 10.1 - QUALIFICATION OF THE OPERATORS IN CHARGE

Uninstallation	
Operator qualification	<ul style="list-style-type: none"> <li>Qualified uninstallation operator</li> </ul>
PPE required	<div style="display: flex; align-items: center;">  </div> <div style="background-color: #f4a460; padding: 5px; margin-top: 5px;"> <p><b>⚠ WARNING!</b></p> </div> <p>The PPE listed in this table is related to the risk associated with the equipment. For the PPE required to protect against risks associated with the workplace, installation or operating conditions, please refer to:</p> <ul style="list-style-type: none"> <li>the regulations in force in the country of installation;</li> <li><u>any information provided by the Safety Manager at the installation facility.</u></li> </ul>
Equipment required	Keys to fix inlet and outlet connections fittings/equipment.

Tab. 10.42.

### 10.2 - UNINSTALLATION

To properly uninstall the equipment, proceed as specified in Tab. 10.43:

Step	Action
1	Close the valves upstream and downstream of the equipment.
2	Disconnect the upstream and downstream pipes from the equipment by unscrewing the fittings with adequate hand tools.
3	<p>Remove the equipment.</p> <div style="border: 1px solid #0070c0; padding: 5px; margin-top: 5px;"> <p><b>! NOTICE!</b></p> <p><b>Seal the valves upstream and downstream of the equipment if:</b></p> <ul style="list-style-type: none"> <li>closing the system;</li> <li><u>the equipment is not replaced immediately.</u></li> </ul> </div>

Tab. 10.43.

### 10.3 - INFORMATION REQUIRED IN CASE OF NEW INSTALLATION

 **NOTICE!**

Should the equipment be reused after uninstallation, refer to chapters: “Installation” and “Configuration”.

### 10.4 - STORAGE OF THE BATTERIES

 **NOTICE!**

Refer to paragraph to store the batteries.

### 10.5 - INFORMATION REQUIRED IN CASE OF RE-INSTALLATION

 **NOTICE!**

Should the equipment be reused after uninstallation, refer to chapter “Installation”

## 10.6 - DISPOSAL INFORMATION

### NOTICE!

- **Proper disposal prevents damage to humans and the environment and promotes the reuse of precious raw materials.**
- **Bear in mind that the regulations in force in the country of installation must be complied with.**
- **Illegal or improper disposal involves the application of the penalties provided for by the regulations in force in the country of installation.**



When removing the device from the field, it must not be disposed of with normal waste. Dispose of the device pursuant to the provisions of It. Legislative Decree 14 March 2014, no. 49 "Implementation of directive 2012/19/EU on waste electric and electronic equipment (WEEE).

The equipment was manufactured with materials that can be recycled by specialised companies. For proper disposal of the equipment, proceed as specified in Tab. 10.44:

Step	Action
1	Set up a large work area free from obstacles where to safely dismantle the equipment.
2	Sort the various components by type of material for easier recycling through separate collection.
3	Send the materials obtained in <b>Step 2</b> to a specialised company.

Tab. 10.44.

The equipment in any configuration consists of the materials described in Tab. 10.45:

Material	Disposal/recycling indications
<b>Composite</b>	It must be dismantled and disposed of separately.
<b>Steel</b>	Disassemble and collect separately. It must be recycled through the specific collection centres.
<b>Brass</b>	Disassemble and collect separately. It must be recycled through the specific collection centres.
<b>Electronic components</b>	Disassemble and collect separately. It must be recycled through the specific collection centres.
<b>Lithium batteries</b>	Consult paragraph "10.6.1 - Disposing of the batteries".

Tab. 10.45.

### NOTICE!

**The above materials refer to standard versions. Different materials can be provided for specific needs.**

### 10.6.1 - DISPOSING OF THE BATTERIES

Proceed with disposal in compliance with the requirements:

- on transport and packaging in the chapter;
- of the legislation in force in the country of installation of the equipment.

#### **WARNING!**

**When disposing of the batteries, they must be removed from the equipment, as indicated in Directive 2006/66/EC art.12 paragraph 3.**

The transport of the batteries to the intermediate treatment plants is not subject to the provisions of the ADR if the volume of each packaging containing the batteries does not exceed 450 litres.

#### **NOTICE!**

**Take steps to prevent any leakage of battery contents under normal transport conditions.**

#### **NOTICE!**

**You can ship batteries and/or batteries for recycling or disposal under a partial exemption scheme, in accordance with special provision 636.**

**This exemption applies to lithium batteries/batteries of gross mass  $\leq$  500 g per unit.**

#### 10.6.1.1 - BATTERY PACKAGING

#### **NOTICE!**

**The packages must be labelled in accordance with ADR, i.e. with a diamond shape on the side and code UN3090.**



#### **NOTICE!**

**The packages must bear the indication "LITHIUM BATTERIES FOR DISPOSAL" or "LITHIUM BATTERIES FOR RECYCLING".**

The batteries that are removed from the equipment must be packed in such a way:

- to be protected from any damage due to transport and handling;
- to prevent any accidental movement;
- to prevent the terminals from bearing the weight of other elements;
- to be protected from short circuits.

For this purpose, the original packaging or alternatively, packaging compliant with the ADR regulations, can be used.

If batteries not removed from the equipment but still inside it are transported, the packaging may not be approved but must still be:

- sufficiently robust and able to contain and protect the equipment;
- constructed in such a way as to prevent the equipment from operating accidentally during transport.

## 11 - RECOMMENDED SPARE PARTS

### 11.1 - GENERAL WARNINGS

#### NOTICE!

If spare parts not recommended are used, PIETRO FIORENTINI S.p.A. their declared performance cannot be guaranteed.

It is recommended to use original spare parts PIETRO FIORENTINI S.p.A.

PIETRO FIORENTINI S.p.A. shall not be held liable for any damage caused by using non-original parts.

### 11.2 - HOW TO REQUEST SPARE PARTS

The SSM-AQUO device has no replaceable parts.

#### NOTICE!

**For specific information, please refer to the sales network of PIETRO FIORENTINI S.p.A.**

TM0109ENG

