

HBC 975

Slam shut valves



TECHNICAL BROCHURE

Pietro Fiorentini S.p.A.

Via E.Fermi, 8/10 | 36057 Arcugnano, Italy | +39 0444 968 511
sales@fiorentini.com

The data are not binding. We reserve the right
to make changes without prior notice.

hbc975_technicalbrochure_ENG_revA

www.f Fiorentini.com

Who we are

We are a global organization specialized in designing and manufacturing technologically advanced solutions for natural gas treatment, transmission and distribution systems.

We are the ideal partner for operators in the Oil & Gas sector, with a business offer that goes across the whole natural gas chain.

We are in constant evolution to meet our customers' highest expectations in terms of quality and reliability.

Our aim is to be a step ahead of the competition, with customized technologies and an after-sale service program undertaken with the highest grade of professionalism.



Pietro Fiorentini advantages



Localised technical support



Experience since 1940



We operate in over 100 countries

Area of Application

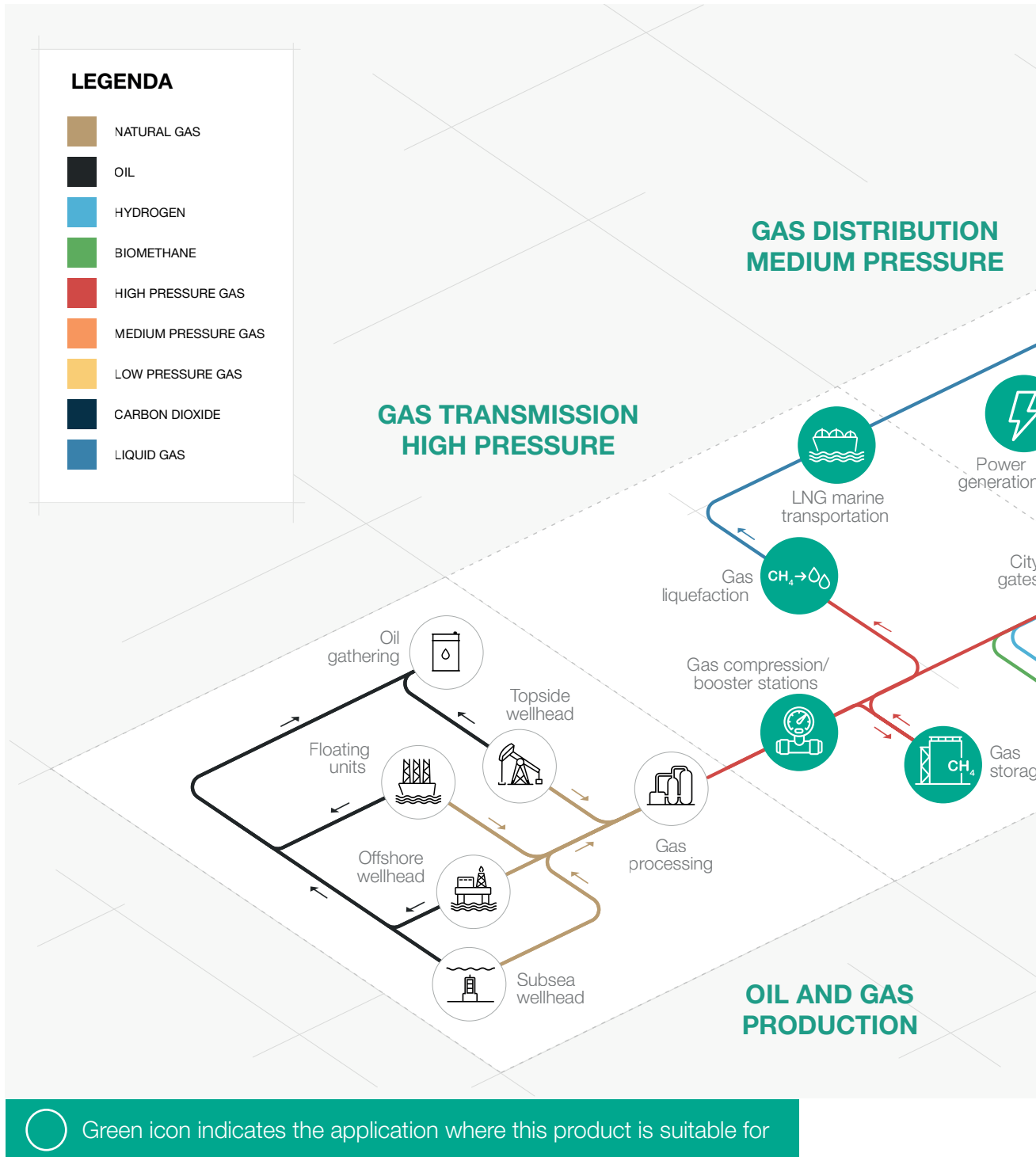

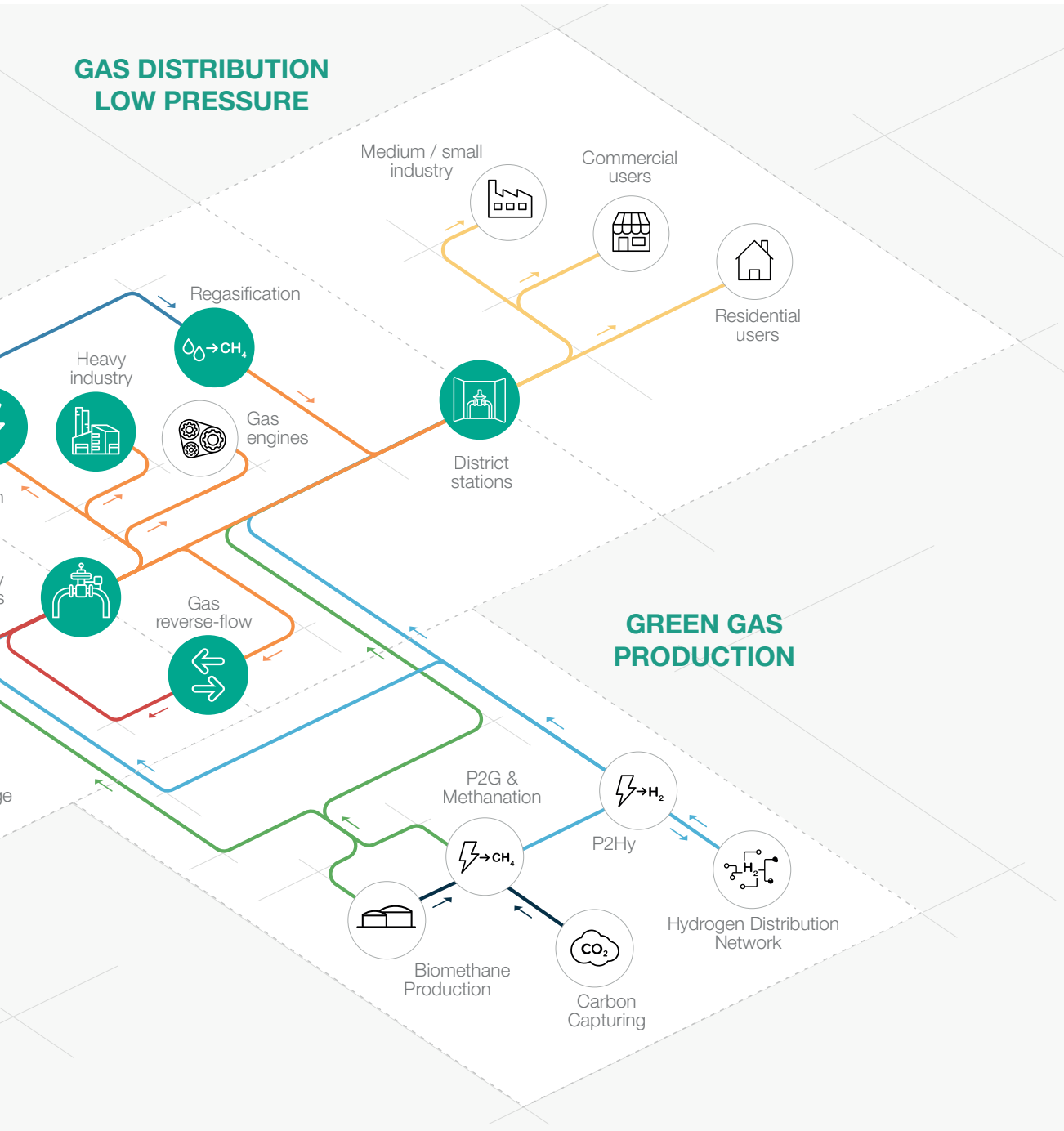

Figure 1 Area of Application Map



Introduction

HBC 975 is a safety device, also called slam shut valve, suitable to quickly interrupt the gas flow when the pressure reaches a calibration set value.

This device is mainly used in high-pressure transmission systems and in medium pressure gas distribution networks.

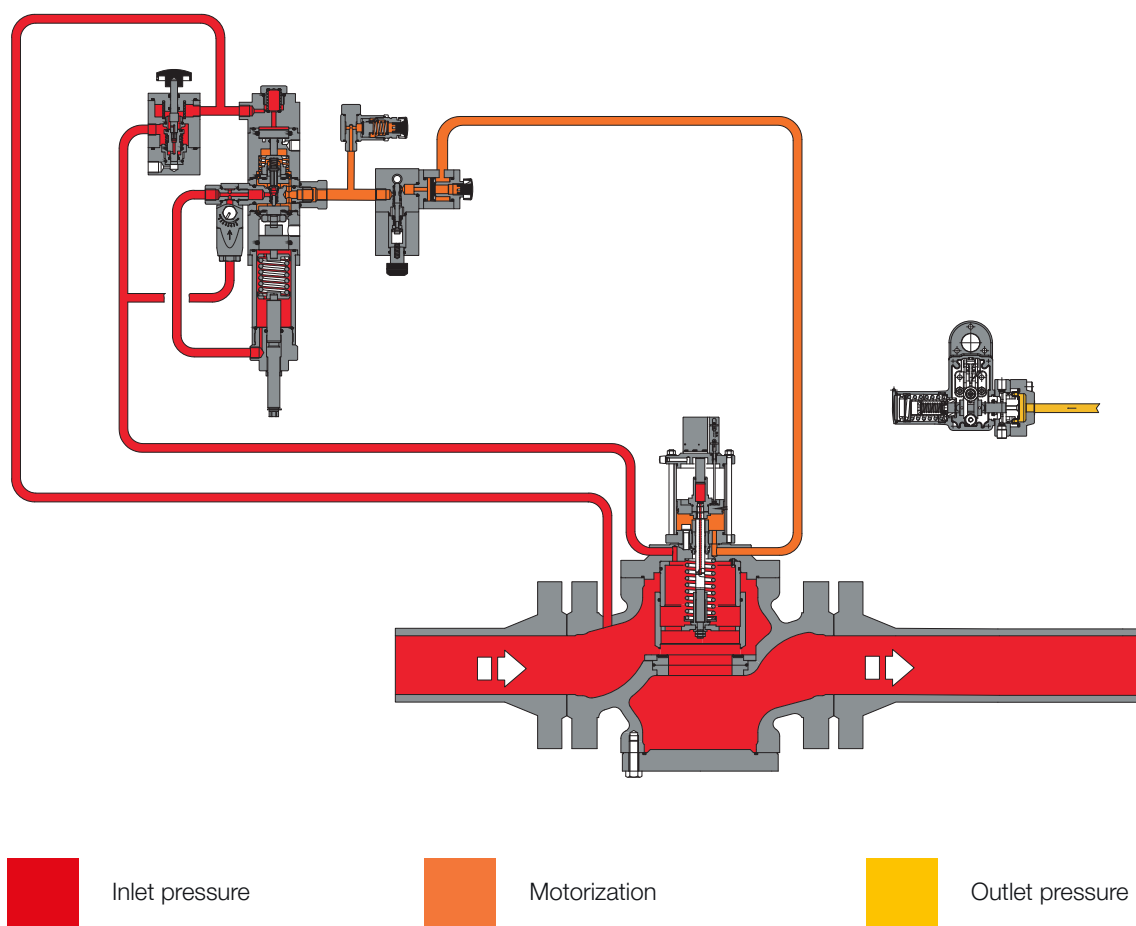

Figure 2 HBC 975

Features and Calibration ranges

A key feature of a slam shut valves is to be **extremely fast in response time**, ensuring the tripping within 1 second. Set point adjustment of the slam shut is operated via a pressostatic device which is sensing the downstream pressure.

The tripping of the slam-shut device, besides occurring **automatically** when the predetermined set-point is exceeded

It can also be enabled locally, by pressing the suitable button available on the pressure switch, or remotely, as a result of the monitoring of the system or network on which the slam-shut device is installed.

As a result of the tripping of the slam-shut valve, the subsequent restoration of the normal operating condition, also called **RESET** operation, is carried out in a **purely manual manner**, after having verified and solved the causes that led to such a tripping.

This slam shut valve is suitable to be used with previously filtered, non corrosive gases, in natural gas transmission, power plants fuel gas skids and distribution networks as well as high load industrial application.

It is a **truly top entry design** which allows an **easy maintenance** of parts directly in the field **without removing the body from the pipework**.

The modular design of HB slam shut valve series allows its retrofitting on existing pressure regulators in the field without piping modifications.

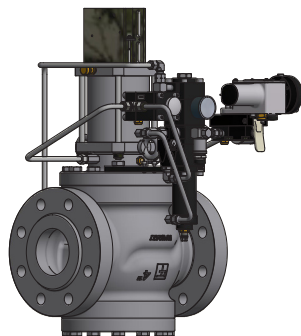











Figure 3 HBC 975



HBC 975 competitive advantages

-  Over Pressure Shut-Off
-  Compact dimensions
-  Under Pressure Shut-Off
-  Easy maintenance
-  Internal by-pass
-  Remote tripping option
-  Push button for tripping test
-  Limit switch option
-  Top Entry
-  Biomethane compatible and available with specific versions for full Hydrogen or blending

Features

Features	Values
Design pressure*	up to 10.2 MPa up to 102 barg
Ambient temperature*	from -20 °C to +60 °C from -4 °F to +140 °F
Inlet gas temperature range*	from -20 °C to +60 °C from -4 °F to +140 °F
Available Accessories	Limit switch, remote tripping
Maximum inlet pressure	10 MPa 100 barg
Accuracy class AG	up to 2.5 for OPSO (depending on working conditions) up to 2.5 for UPSO (depending on working conditions)
Over pressure setting range (OPSO)	from 0.02 MPa to 9 MPa from 0.2 barg to 90 barg
Under pressure setting range (UPSO)	from 0.02 MPa to 9 MPa from 0.2 barg to 90 barg
Nominal dimensions DN	DN 100 / 4"; DN 150 / 6"; DN 200 / 8"; DN 250 / 10"; DN 300 / 12"
Connections*	ANSI 150, 300 and 600 according to ASME B16.5 and PN 16 according EN 1092
End to end dimensions	according to EN 334, EN 14382

(*) REMARK: Different functional features and/or extended temperature ranges available on request. Stated temperature ranges are the maximum for which the equipment's full performance, including accuracy, are fulfilled. Standard product may have a narrower range.

Table 1 Features

Materials and Approvals

Part	Material
Body	Cast steel ASTM A 352 LCC for classes ANSI 300 and 600; Cast steel ASTM A 216 WCB for classes ANSI 150 and PN 16
Stem	AISI 416 stainless steel
Plug	ASTM A 350 LF2 Nickel coated
Valve seat	Carbon steel + vulcanized rubber
Sealing ring	Nitrile rubber
Compression fittings	Zinc-plated carbon steel according to DIN 2353; Stainless steel on request

REMARK: The materials indicated above refer to the standard models. Different materials can be provided according to specific needs.

Table 2 Materials

Construction Standards and Approvals

HBC 975 slam shut valve is designed according to the European standard EN 14382.

The product is certified according to European Directive 2014/68/EU (PED).

Leakage class: bubble tight, better than VIII according to ANSI/FCI 70-3.



EN 14382



PED-CE



Pressure switch

types and ranges

Pressure switch types and ranges					
SSV Type	Model	Operation	Range Wh		Spring Table web link
			MPa	barg	
HB/97	102M	OPSO	0.02 - 0.55	0.2 - 5.5	TT 1331
		UPSO	0.02 - 0.28	0.2 - 2.8	
HB/97	102MH	OPSO	0.02 - 0.55	0.2 - 5.5	TT 1331
		UPSO	0.28 - 0.55	2.8 - 5.5	
HB/97	103M	OPSO	0.2 - 2.2	2 - 22	TT 1331
		UPSO	0.02 - 0.8	0.2 - 8	
HB/97	103MH	OPSO	0.2 - 2.2	2 - 22	TT 1331
		UPSO	0.8 - 1.9	8 - 19	
HB/97	104M	OPSO	1.5 - 4.5	15 - 45	TT 1331
		UPSO	0.16 - 1.8	1.6 - 18	
HB/97	104MH	OPSO	1.5 - 4.5	15 - 45	TT 1331
		UPSO	1.8 - 4.1	18 - 41	
HB/97	105M	OPSO	3 - 9	30 - 90	TT 1331
		UPSO	0.3 - 4.4	3 - 44	
HB/97	105MH	OPSO	3 - 9	30 - 90	TT 1331
		UPSO	4.4 - 9	44 - 90	

Table 3 Settings table

General link to the calibration tables: [PRESS HERE](#) or use the QR code:



Accessories

- Limit switches
- Remote tripping

In-line Installation

The following example is provided as a recommendation to get the best performance from the slam shut valves HBC 975.

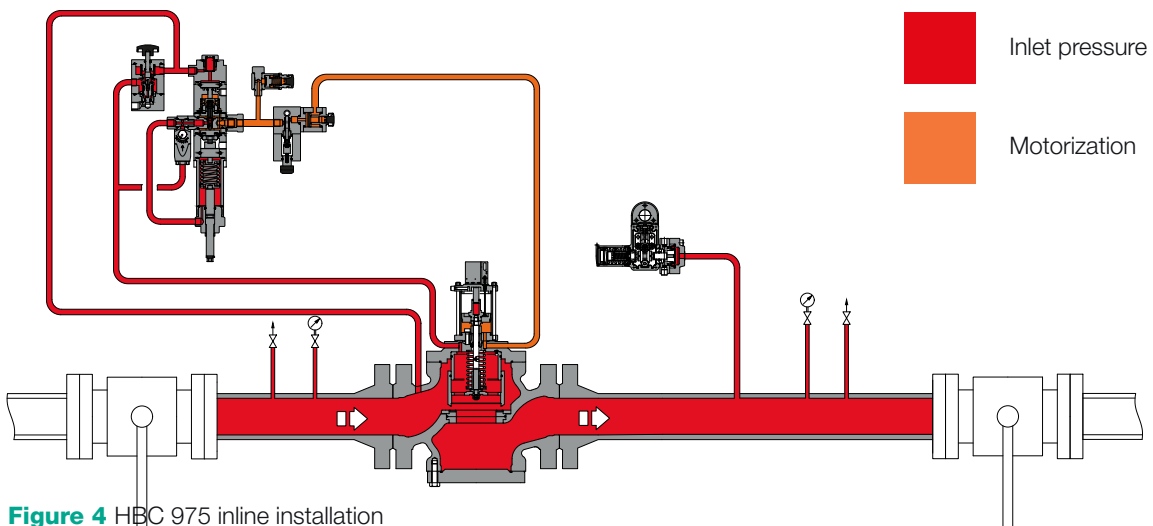

Figure 4 HBC 975 inline installation

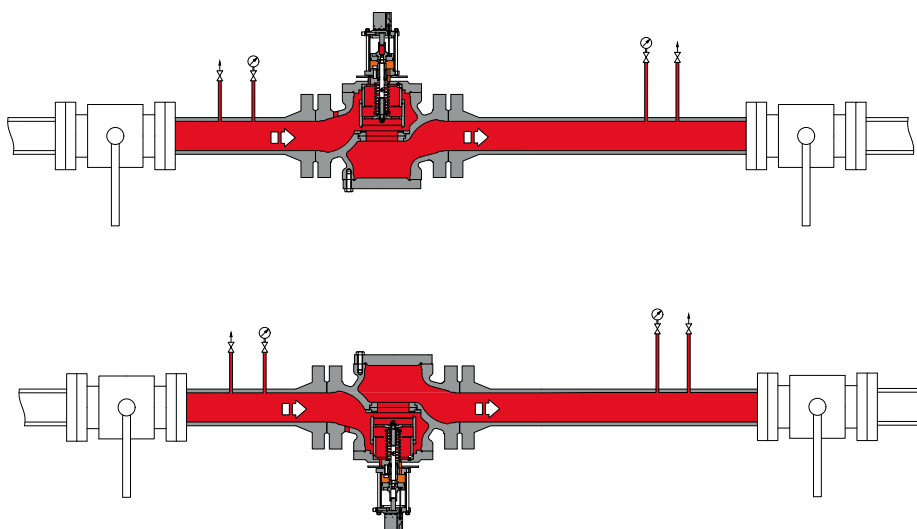

Figure 5 HBC 975 recommended installations



Weights and Dimensions

HBC 975

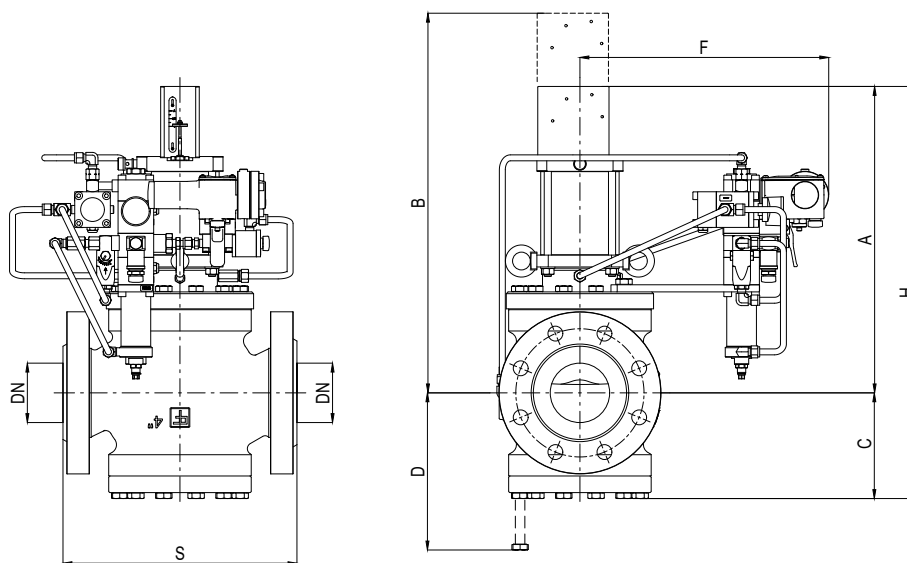

Figure 6 HBC 975 dimensions

Weights and Dimensions (for other connections please contact your closest Pietro Fiorentini representative)										
Size (DN) - [mm]	100		150		200		250		300	
Size (DN) - inches	4"		6"		8"		10"		12"	
	[mm]	inches	[mm]	inches	[mm]	inches	[mm]	inches	[mm]	inches
S - ANSI 150/PN16	352	13.9"	451	17.8"	543	21.4"	673	26.5"	737	29.0"
S - ANSI 300	368	14.5"	473	18.6"	568	22.4"	708	27.9"	775	30.5"
S - ANSI 600	394	15.5"	508	20.0"	609	24.0"	752	29.6"	819	32.2"
A	518	20.4"	645	25.4"	687	27.0"	796	31.3"	940	37.0"
B	650	25.6"	835	32.9"	900	35.4"	1060	41.7"	1220	48.0"
C	180	7.1"	225	8.9"	265	10.4"	340	13.4"	372	14.6"
D	205	8.1"	275	10.8"	320	12.6"	440	17.3"	480	18.9"
F	358	14.1"	410	16.1"	445	17.5"	510	20.1"	530	20.9"
H	700	27.6"	870	34.3"	952	37.5"	1336	52.6"	1312	51.7"
Tubing Connections	Øe 10 x Øi 8 (on request imperial sizing)									
Weight	Kg	lbs	Kg	lbs	Kg	lbs	Kg	lbs	Kg	lbs
ANSI 150/PN16	104	229	233	514	305	672	600	1323	1125	2480
ANSI 300	120	265	239	527	349	769	650	1433	1200	2646
ANSI 600	131	289	256	564	375	827	700	1543	1300	2866

Table 4 Weights and dimensions

Sizing and Cg

In general, the choice of a slam-shut valve is made of several factors, but primarily by the differential pressure drop generated downstream and the energy generated by the gas flow on the internal mechanism. For this purpose Pietro Fiorentini has developed a specific online tool for slam-shut valve sizing following the calculation guidelines available from EN14382 standard.

For sizing [PRESS HERE](#) or use the QR code:



Note: In case you do not have the proper credentials to access, feel free to contact your closest Pietro Fiorentini representative.



Customer Centricity

Pietro Fiorentini is one of the main Italian international companies with high focus on product and service quality.

The main strategy is to create a stable long-term oriented relationship, putting the customer's needs first. Lean management and thinking and customer centricity are used to improve and maintain the highest level of customer experience.



Support

One of Pietro Fiorentini's top priorities is to provide support to the client in all phases of project development, during installation, commissioning and operation. Pietro Fiorentini has developed a highly standardized intervention management system, which helps to facilitate the entire process and effectively archive all the interventions carried out, drawing on valuable information to improve the product and service. Many services are available remotely, avoiding long waiting times or expensive interventions.



Training

Pietro Fiorentini offers training services available for both experienced operators and new users. The training is composed of the theoretical and the practical parts, and is designed, selected and prepared according to the level of use and the customer's need.



Customer Relation Management (CRM)

The centrality of customer is one of the main missions and vision of Pietro Fiorentini. For this reason, Pietro Fiorentini has enhanced the customer relation management system. This enables to track every opportunity and request from Customer in one single point and make free the information flow.



Pietro Fiorentini

TB0043ENG



The data are not binding. We reserve the right
to make changes without prior notice.

hbc975_technicalbrochure_ENG_revA

www.fiorentini.com