

VS/AM 65

Relief valve



Revision B - Edition 06/2024



**USE, MAINTENANCE
AND WARNING
MANUAL**

1 - INTRODUCTION

FOREWORD

All rights reserved. No part of this publication may be reproduced, distributed, translated into other languages or transmitted by any electronic or mechanical media, including photocopies, recording or any other storage and retrieval system, for any other purposes that are not exclusively the personal use of the buyer, without the express written permission of the Manufacturer.

The manufacturer is in no way responsible for the consequences of operations carried out in a manner not in accordance with the manual.

GENERAL REMARKS

All operating, maintenance instructions and recommendations described in this manual must be followed to in order to:

- get the best possible performance from the device;
- maintain the device in an efficient condition;
- carry out maintenance work regularly.

Training the personnel in charge is essential in order to:

- the use and maintenance of the device in the correct manner;
- correctly apply the safety alerts and recommended procedures.

Revision: B

1.1 - REVISION HISTORY

Revision index	Date
A	03/2023
B	06/2024

Tab. 1.1.

1 - INDEX

1 - INTRODUCTION	3
1.1 - REVISION HISTORY.....	5
2 - GENERAL INFORMATION	9
2.1 - MANUFACTURER IDENTIFICATION	9
2.2 - IDENTIFICATION OF THE PRODUCT	9
2.3 - REGULATORY FRAMEWORK.....	9
2.4 - WARRANTY	10
2.5 - ADDRESSEES, SUPPLY AND STORAGE OF THE MANUAL	10
2.6 - LANGUAGE	10
2.7 - SYMBOLS USED IN THE MANUAL.....	11
2.8 - APPLIED RATING PLATES	12
2.8.1 - GLOSSARY FOR RATING PLATES.....	13
2.9 - GLOSSARY OF MEASUREMENT UNITS.....	14
2.10 - QUALIFIED PROFESSIONAL FIGURES	15
3 - SAFETY	17
3.1 - GENERAL SAFETY WARNINGS.....	17
3.2 - PERSONAL PROTECTIVE EQUIPMENT.....	18
3.3 - OBLIGATIONS AND PROHIBITIONS	19
3.4 - RESIDUAL RISKS	19
3.4.1 - TABLE SHOWING RESIDUAL RISKS DUE TO PRESSURE	20
3.4.2 - TABLE OF RESIDUAL RISKS FOR POTENTIALLY EXPLOSIVE ATMOSPHERES	22
3.5 - SAFETY PICTOGRAMS	24
3.6 - NOISE LEVEL	24
4 - DESCRIPTION AND OPERATION	25
4.1 - GENERAL DESCRIPTION	25
4.2 - OPERATION.....	26
4.3 - INTENDED USE	27
4.3.1 - ENVISAGED USE	27
4.3.2 - REASONABLY FORESEEABLE MISUSE	27
4.3.3 - TYPES OF FLUIDS	27
4.4 - MODELS AND CONFIGURATIONS	28
4.5 - TECHNICAL FEATURES/PERFORMANCE	29

5 - TRANSPORT AND HANDLING 31

5.1 - SPECIFIC WARNINGS FOR TRANSPORT AND HANDLING	31
5.1.1 - PACKAGING AND FASTENERS USED FOR TRANSPORT	32
5.2 - PACKAGING CONTENT.....	32
5.3 - PHYSICAL CHARACTERISTICS OF THE DEVICE	32
5.4 - DEVICE ANCHORING AND LIFTING METHOD	34
5.4.1 - FORKLIFT HANDLING METHOD.....	35
5.5 - PACKAGING REMOVAL.....	37
5.5.1 - PACKAGING DISPOSAL	37
5.6 - STORAGE AND ENVIRONMENTAL CONDITIONS	38
5.6.1 - STORAGE LASTING LONGER THAN THE MAXIMUM TIME ALLOWED	38

6 - INSTALLATION 39

6.1 - INSTALLATION PRE-REQUISITES.....	39
6.1.1 - ALLOWED ENVIRONMENTAL CONDITIONS.....	39
6.1.2 - STORAGE LASTING LONGER THAN THE MAXIMUM TIME ALLOWED	39
6.1.3 - CHECKS BEFORE INSTALLATION.....	40
6.2 - SPECIFIC SAFETY INSTRUCTIONS FOR THE INSTALLATION STEP	41
6.3 - POSSIBLE INSTALLATIONS OF THE DEVICE	42
6.4 - INSTALLATION PROCEDURE	43
6.4.1 - DEVICE INSTALLATION PROCEDURE	44
6.5 - POST-INSTALLATION CHECKS	44

7 - COMMISSIONING/MAINTENANCE EQUIPMENT..... 45

7.1 - LIST OF EQUIPMENT.....	45
------------------------------	----

8 - COMMISSIONING 47

8.1 - GENERAL WARNINGS	47
8.1.1 - SAFETY REQUIREMENTS FOR COMMISSIONING	47
8.2 - PRELIMINARY PROCEDURES FOR COMMISSIONING	48
8.3 - DEVICE CALIBRATION.....	48
8.4 - DEVICE COMMISSIONING PROCEDURE.....	49
8.4.1 - COMMISSIONING WITHOUT SHUT-OFF VALVE	50
8.4.2 - COMMISSIONING WITH SHUT-OFF VALVE.....	50
8.5 - DEVICE SETTINGS	51

9 - MAINTENANCE AND FUNCTIONAL CHECKS.....	53
9.1 - GENERAL WARNINGS	53
9.2 - PERIODICALLY CHECKING AND INSPECTING THE EQUIPMENT FOR PROPER OPERATION.....	55
9.2.1 - LEAK TESTING	55
9.3 - ROUTINE MAINTENANCE	56
9.3.1 - GENERAL SAFETY WARNINGS.....	56
9.3.2 - REPLACEMENT FREQUENCY FOR COMPONENTS SUBJECT TO WEAR	56
9.4 - ROUTINE MAINTENANCE PROCEDURES.....	58
9.4.1 - PRELIMINARY OPERATIONS.....	58
9.4.2 - DISASSEMBLY/REASSEMBLY.....	58
10 - TROUBLESHOOTING.....	65
10.1 -GENERAL WARNINGS	65
10.2 -OPERATOR QUALIFICATION SPECIFICATION.....	66
10.3 -TROUBLESHOOTING PROCEDURES	66
10.4 -TROUBLESHOOTING TABLE.....	66
11 - UNINSTALLATION AND DISPOSAL	67
11.1 -GENERAL SAFETY WARNINGS.....	67
11.2 -QUALIFICATION OF THE OPERATORS IN CHARGE.....	67
11.3 -UNINSTALLATION.....	67
11.4 -INFORMATION REQUIRED IN CASE OF RE-INSTALLATION.....	68
11.5 -DISPOSAL INFORMATION.....	68
12 - RECOMMENDED SPARE PARTS	69
12.1 -GENERAL WARNINGS	69
12.2 -HOW TO REQUEST SPARE PARTS.....	69
13 - CALIBRATION TABLES	71
13.1 -CALIBRATION TABLES.....	71

2 - GENERAL INFORMATION

2.1 - MANUFACTURER IDENTIFICATION

Manufacturer	PIETRO FIORENTINI S.P.A.
Address	Via Enrico Fermi, 8/10 36057 Arcugnano (VI) - ITALY Tel. +39 0444 968511 Fax +39 0444 960468 www.fiorentini.com sales@fiorentini.com

Tab. 2.2.

NOTICE!

For any problems with the device, please contact your gas network distributor.

2.2 - IDENTIFICATION OF THE PRODUCT

Device	RELIEF VALVE
Series	VS/AM 65
Available models	<ul style="list-style-type: none"> • VS/AM 65 BP • VS/AM 65 MP • VS/AM 65 TR

Tab. 2.3.

2.3 - REGULATORY FRAMEWORK

PIETRO FIORENTINI S.P.A. with registered office in Arcugnano (Italy) - Via E. Fermi, 8/10, declares under its sole responsibility that the relief valve covered by this manual, is classified as a safety accessory and is:

- compliant with the Pressure Equipment Directive 2014/68/EU (PED), IV Category;
- designed, manufactured, tested and controlled in accordance with the requirements of the standards: UNI 11655:2016, UNI EN 16129:2013, UNI EN 334:2019 where applicable.

NOTICE!

For specific type approvals, see the appropriate section on the Manufacturer's website: <https://www.fiorentini.com>

NOTICE!

The declaration of conformity in its original version is delivered together with the device and this manual.

2.4 - WARRANTY

PIETRO FIORENTINI S.P.A. guarantees that the device was manufactured using the best materials, with high quality workmanship, and complies with the quality requirements, specifications and performance set out in the order.

The warranty shall be considered null and void and PIETRO FIORENTINI S.P.A. shall not be liable for any damage and/or malfunctions:

- due to any acts or omissions of the purchaser or end-user, or any of their carriers, employees, agents, or any third party or entity;
- in the event that the purchaser, or a third party, makes changes to the device supplied by PIETRO FIORENTINI S.P.A. without the prior written approval of the latter;
- in the event of failure by the purchaser to comply with the instructions contained in this manual, as provided by PIETRO FIORENTINI S.P.A.

NOTICE!

The warranty conditions are specified in the commercial contract.

2.5 - ADDRESSEES, SUPPLY AND STORAGE OF THE MANUAL

The instruction manual is intended for qualified technicians responsible for operating and managing the device throughout its service life.

It contains the necessary information to properly use the device and keep its functional and qualitative characteristics unchanged over time. All information and warnings for safe, correct use are also provided.

The manual, as well as the declaration of conformity and/or test certificate, is an integral part of the device and must always accompany it whenever it is moved or resold. It is the responsibility of the qualified professionals (see paragraph 2.10) to use and manage the device.

WARNING!

Removing, rewriting or editing the pages of the manual and their contents is not allowed.

PIETRO FIORENTINI S.p.A. shall not be held liable for any damage to people, animals and property caused by failure to adhere to the warnings and operating procedures described in this manual.

2.6 - LANGUAGE

The original instruction manual was drawn up in Italian.

Any translations into additional languages are to be made from the original instruction manual.

HAZARD!

The translations into other languages cannot be fully verified. If any inconsistency is found, please refer to the text of the original manual.



If inconsistencies are found or the text does not make sense:

- **stop any actions;**
- **immediately contact PIETRO FIORENTINI S.p.A. at the addresses specified in paragraph 2.1 (“Identification of the manufacturer”).**

WARNING!

PIETRO FIORENTINI S.p.A. shall be held liable for the information provided in the original manual only.

2.7 - SYMBOLS USED IN THE MANUAL

Symbol	Definition
	Symbol used to identify important warnings for the safety of the operator and/or device.
	Symbol used to identify information of particular importance in the instruction manual. The information may also concern the safety of the personnel involved in using the device.
	Obligation to consult the instruction manual. Indicates a requirement for the personnel to refer to (and understand) the instruction manual before working with or on the device.

Tab. 2.4.

HAZARD!

Alerts to a hazard with a high level of risk, an imminent hazardous situation which, if not prevented, will result in death or severe damage.

WARNING!

Alerts to a hazard with a medium level of risk, a potentially hazardous situation which, if not prevented, may result in death or severe damage.

ATTENTION!

Alerts to a hazard with a low level of risk, a potentially hazardous situation which, if not prevented, could result in minor or moderate damage.

NOTICE!

Alerts to specific warnings, directions or notes of particular concern, that are not related to physical injury, as well as practices for which physical injury is not likely to occur.

2.8 - APPLIED RATING PLATES

WARNING!



Removing nameplates and/or replacing them with other plates is strictly not allowed. Should the plates be unintentionally damaged or removed, the customer must notify **PIETRO FIORENTINI S.p.A.**

The device is equipped with rating plate (A):

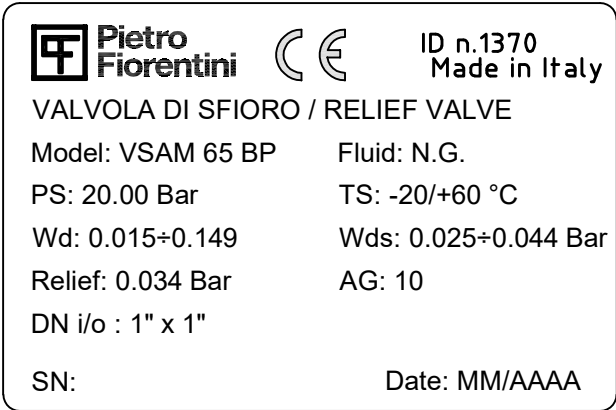

Fig. 2.1. Positioning of rating plate

The nameplate (A) contains the identification details of the device and its accessories to be mentioned in case of need at PIETRO FIORENTINI S.p.A.:

Type	Image
IDENTIFICATION PLATE	 <p> Pietro Fiorentini  ID n.1370 Made in Italy VALVOLA DI SFIORO / RELIEF VALVE Model: VSAM 65 BP Fluid: N.G. PS: 20.00 Bar TS: -20/+60 °C Wd: 0.015÷0.149 Wds: 0.025÷0.044 Bar Relief: 0.034 Bar AG: 10 DN i/o : 1" x 1" SN: Date: MM/AAAA </p>

Tab. 2.5.

2.8.1 - GLOSSARY FOR RATING PLATES

The terms and abbreviations used on the rating plate are described in Tab. 2.6.:

Term	Description
CE	CE marking ensuring the conformity of the product with the requirements of the applicable EU directives or regulations.
ID	Identifier of the body that issued the CE marking.
Model	Device model.
PS	Maximum admissible pressure that can be supported in safe conditions by the structure of the body of the device (Bar).
Wd	Calibration range of the device that can be obtained by using the setting springs indicated in the appropriate tables.
Relief	Relief valve cut-in pressure (Bar).
DN i/o	Nominal diameter of device inlet/outlet connections.
SN	Serial number of the device.
Fluid	Type of gas that the device can be used with.
TS	Device design temperature range (°C).
Wds	Calibration range of the device that can be achieved using the parts and setting spring fitted at the time of testing (Bar).
AG	Accuracy of device intervention.
Date	Month and year of manufacture of the device.

Tab. 2.6.

2.9 - GLOSSARY OF MEASUREMENT UNITS

Type of measurement	Unit of measurement	Description
Volumetric flow rate	Sm ³ /h	Standard cubic metres per hour
	Sm ³	Standard cubic metres
	m ³ /h	Cubic metres per hour
	m ³	Cubic metres
Pressure	bar	Unit of measurement in the CGS system
	"wc	Water column inch
	Pa	Pascal
Temperature	°C	Degree centigrade
	°F	Fahrenheit degree
	K	Kelvin
Tightening torque	Nm	Newton metre
Sound pressure	dB	Decibel
Other measures	V	Volt
	W	Watt
	F	Farad
	H	Henry
	A	Ampere
	Ω	Ohm

Tab. 2.7.

2.10 - QUALIFIED PROFESSIONAL FIGURES

Qualified operators in charge of using and managing the device throughout its technical service life:

Professional figure	Definition
<p>Installer</p>	<p>Qualified operator able to:</p> <ul style="list-style-type: none"> • handle materials and equipment; • carry out all the operations necessary to properly install the device; • perform all the operations necessary for the proper functioning of the device and the system in safety; • be able to perform all the operations necessary to uninstall and subsequently dispose of the device in compliance with the regulations in force in the country of installation.
<p>User's technician / Specialised technician</p>	<p>Technician trained and authorised to use and manage the device for the activities it was supplied for. They must:</p> <ul style="list-style-type: none"> • be able to perform all operations required for the proper functioning of the device and the system, and for their safety and that of any third parties present; • perform maintenance on all parts of the device subject to maintenance; • access all device parts for visual inspection, checking equipment status, making adjustments and calibrations; • have proven experience in properly using the equipment similar to that described in this manual, and be trained, informed and instructed in this regard.

Tab. 2.8.

PAGE INTENTIONALLY LEFT BLANK

3 - SAFETY

3.1 - GENERAL SAFETY WARNINGS

WARNING!

The device described in this manual is:

- subject to pressure in pressurised systems;
- normally installed in systems carrying flammable gases (for example: natural gas).

WARNING!

If the gas used is a combustible gas, the installation area of the device is defined as a “danger zone” as there are residual risks that potentially explosive atmospheres may be generated.

In “danger zones” and in close proximity thereto:

- there must not be any effective sources of ignition;
- no smoking.

WARNING!

- It is strictly forbidden to repair or make any modifications to the device.
- For information and warnings concerning the maintenance of the device, please refer to Chapter 9 of this manual.

ATTENTION!

Authorised operators must not carry out operations or services on their own initiative that do not fall within their competence.

Never interfere with the device:

- while under the influence of intoxicating substances such as alcohol;
- if you are using drugs that may slow reaction times.

NOTICE!

The employer must train and inform operators:

- on how to behave during operations;
- on the equipment to be used.

Before installation, commissioning or maintenance, operators must:







- take note of the safety regulations applicable to the place of installation they are working in;
- obtain the necessary permits to operate when required;
- wear the personal protective equipment required by the procedures described in this instruction manual;
- ensure that the required collective protective equipment and safety information are available in the area they are operating in.

3.2 - PERSONAL PROTECTIVE EQUIPMENT

The following table shows the Personal Protective Equipment (PPE) and its description; an obligation is associated with each symbol.

Personal protective equipment means any equipment intended to be worn by the worker in order to protect them against one or several risks that are likely to threaten their safety or health during work.

For the operators in charge, depending on the type of work requested, the most appropriate PPE from those reported in Tab.3.9 must be used:

Symbol	Meaning
	Obligation to use safety or insulated gloves. Indicates a requirement for the personnel to use safety or insulated gloves.
	Obligation to use safety goggles. Indicates a requirement for personnel to use protective goggles for eye protection.
	Obligation to use safety shoes. Indicates a requirement for the personnel to use accident-prevention safety shoes.
	Obligation to use noise protection equipment. Indicates a requirement for the personnel to use ear muffs or ear plugs to protect their hearing.
	Obligation to wear protective clothing. Indicates a requirement for the personnel to wear specific protective clothing.
	Obligation to use a protective mask. Indicates a requirement for the personnel to use respiratory masks in the event of a chemical risk.
	Obligation to use a protective helmet. Indicates a requirement for the personnel to use protective helmets.
	Obligation to wear high visibility vests. Indicates a requirement for the personnel to use high visibility vests.

Tab. 3.9.

WARNING!

Each licensed operator is obliged to:

- **take care of his/her own health and safety and that of other people in the workplace who are affected by his/her actions or omissions, in accordance with the training, instructions and equipment provided by the employer;**
- **appropriately use the PPE made available;**
- **immediately report to the employer, the manager or the person in charge any deficiencies in the equipment and devices, as well as any dangerous conditions they may become aware of.**

3.3 - OBLIGATIONS AND PROHIBITIONS

The following is a list of obligations and prohibitions to be observed for the safety of the operator:

It is mandatory to:

- carefully read and understand the use, maintenance and warning manual;
- before installing the device, strictly refer to the details specified on the nameplates and in the manual;
- avoid knocks and violent impact that could damage the device.

It is forbidden to:

- operate in various capacities on the device without the PPE indicated in the work procedures described in this manual;
- operate in the presence of open flames or bring open flames close to the work area;
- smoking near the device or while working on it;
- use the device with parameters other than those indicated on the nameplate;
- use the device with gas units other than those indicated on the meter nameplate;
- use the device outside the operating temperature range declared on the identification plate and indicated in this manual;
- install or use the device in environments other than those specified in this manual.

3.4 - RESIDUAL RISKS

WARNING!

If there are any functional faults, do not operate.

Immediately contact PIETRO FIORENTINI S.p.A. for the necessary directions.

In accordance with the requirements of PED Directive 2014/68/EU point 1.2 of Annex I, below is an assessment of the risks associated with the device and an indication of the principles adopted for their prevention, according to the following classification:

- a) Elimination and/or reduction of the risk.
- b) Application of appropriate protective measures.
- c) information to users about residual risks.

3.4.1 - TABLE SHOWING RESIDUAL RISKS DUE TO PRESSURE

 **WARNING!**

If there are any functional faults, do not operate. Immediately contact PIETRO FIORENTINI S.p.A. for the necessary directions.

Risk and Hazard	Event and Cause	Effect and Consequence	Solution and Prevention
Pressurised gas leak. Projection of metallic and non-pressurised parts.	<ul style="list-style-type: none"> violent impact; impact (also due to falling, improper handling, etc.). 	<ul style="list-style-type: none"> deformation; breakage of connections and, if pressurised, even burst. 	a. Handling and installation with appropriate devices to avoid localised stress. b. Installation in suitable places and spaces with appropriate guards and packaging. c. Information in the technical manual.
Pressurised gas leak. Projection of metallic and non-pressurised parts.	<ul style="list-style-type: none"> Use of inappropriate fluids. 	<ul style="list-style-type: none"> corrosion; embrittlement; explosion. 	a. The user must check compliance of the used fluid with what is indicated on the installation sheet.
Pressurised gas leak. Projection of metallic and non-pressurised parts.	<ul style="list-style-type: none"> operation at temperatures below the minimum permissible temperature. 	<ul style="list-style-type: none"> embrittlement; breaking; explosion. 	a. Install in places where the temperature is not below the minimum permissible temperature and/or insulate the device adequately. b. The minimum temperature allowed is indicated on the data plate.
Pressurised gas leak. Projection of metallic and non-pressurised parts. Explosion.	<ul style="list-style-type: none"> overpressure or exceeding of the rated limit values (maximum pressure allowed) 	<ul style="list-style-type: none"> explosion; breaks; cracks; permanent deformation. 	a. The device has appropriate design safety margins. b. The user must check the maximum pressure applicable to the equipment. c. The maximum allowable pressure is highlighted on the appropriate plate on the device.
Pressurised fluid leakage. Projection of metallic and non-pressurised parts.	<ul style="list-style-type: none"> incorrect attachment of the device. 	<ul style="list-style-type: none"> deformation; breaking. 	The device is equipped with unified type process connections and compression fittings. b. The installer must ensure correct fixing to the line. c. Indications in the technical manual.
Explosion of the appliance pressurised fluid leakage. Projection of metallic parts.	<ul style="list-style-type: none"> operation at temperatures above the maximum permissible temperature. 	<ul style="list-style-type: none"> reduction of mechanical resistance and breakage of the device; explosion. 	a. The commissioning technician must equip the system with suitable control and safety devices. b. The maximum permissible temperature is indicated on the installation sheet.
Pressurised gas leak. Projection of metallic and non-pressurised parts.	<ul style="list-style-type: none"> electrostatic potential, differential stray currents. 	<ul style="list-style-type: none"> corrosion localised in the device. 	b. The commissioning technician must equip the device with the necessary means of protection and earthing if indicated on the installation sheet. c. The above requirements are indicated in the technical manual.

Risk and Hazard	Event and Cause	Effect and Consequence	Solution and Prevention
Pressurised gas leak. Projection of metallic and non-pressurised parts.	<ul style="list-style-type: none"> • humidity; • environments with aggressive atmosphere. 	<ul style="list-style-type: none"> • deterioration of external surfaces; • corrosion. 	a. The user must shut off the line and contact PIETRO FIORENTINI S.p.A.

Tab. 3.10.

3.4.2 - TABLE OF RESIDUAL RISKS FOR POTENTIALLY EXPLOSIVE ATMOSPHERES

Table 3.11 shows the conditions that can lead to the generation of a potentially explosive atmosphere respectively for:

- the pressure regulator;
- the monitor;
- the slam-shut device.

The table is valid for use with natural gas with a density of no more than 0.8; for different densities, the installation and environmental conditions must also be evaluated.

 **WARNING!**

If the gas used is a combustible gas, the installation area of the device is defined as a “danger zone” as there are residual risks that potentially explosive atmospheres may be generated.

There must be no effective sources of ignition in “danger zones” and in close proximity thereto.



Operating conditions	Potentially explosive atmosphere	Normative references	Management measures included in the instructions for use and warning
First start-up	No	<ul style="list-style-type: none"> • During the production cycle and before the CE marking according to Directive 2014/68/EC, the external tightness of the device is checked at a value of 1.1 PS, in accordance with Standard EN 334. • Before commissioning, the external tightness of the portion of the system on which the device is installed is checked at a suitable pressure (according to Standards EN 12186 and EN 12279). 	The instructions for use indicate the need to meet the requirements in Standards EN 12186 and EN 12279.
Operation in normal conditions	No	<p>The indications in the previous point apply, in addition:</p> <ul style="list-style-type: none"> • the device is installed outdoors or in an environment with natural ventilation according to Standards EN 12186 and EN 12279; • the installation is subject to surveillance according to current national rules/good practice/the device manufacturer’s instructions (in accordance with the provisions of Standard EN 12186 and Standard EN 12279). 	<p>The instructions for use indicate that:</p> <ul style="list-style-type: none"> • any environment in which the device is installed must meet the requirement of Standards EN 12186 and EN 12279; • periodic checks and maintenance must be carried out during surveillance in accordance with the national rules in force (if any), and with the specific manufacturer’s recommendations.
Breakage of the control head diaphragm (malfunction)	No	<p>This event must be considered a rare malfunction.</p> <p>All atmospheric pressure chambers delimited on at least one side by a diaphragm must be channelled to a safe area (in accordance with the provisions of Standard EN 12186 and Standard EN 12279).</p>	The instructions for use indicate the need to meet the requirements of Standards EN 12186 and EN 12279.

Operating conditions	Potentially explosive atmosphere	Normative references	Management measures included in the instructions for use and warning
Breakage of other non-metallic parts (malfunction)	No	This type of malfunction is not reasonably expected as it involves static seals (to the outside) that cannot generate any external leakage.	-
Decommissioning	No	<ul style="list-style-type: none"> The pressure of the system section in which the device is installed must be reduced with appropriate vent lines channelled to a safe area (according to the provisions of Standard EN 12186 and Standard EN 12279). The residual gas must be discharged as indicated above. 	The instructions for use indicate the need to meet the requirements of Standards EN 12186 and EN 12279
Reboot	No	<ul style="list-style-type: none"> After reassembling the regulator, carry out an external leakage test at a convenient pressure value as specified by the manufacturer. Before commissioning, the external tightness of the portion of the system on which the device is installed is checked at a suitable pressure (according to Standards EN 12186 and EN 12279). 	The instructions for use indicate: <ul style="list-style-type: none"> the minimum conditions for testing internal leakage; the need to meet the requirements of Standards EN 12186 and EN 12279.

Tab. 3.11.

3.5 - SAFETY PICTOGRAMS

The following safety pictograms may be shown on the equipment and/or packaging PIETRO FIORENTINI S.p.A.:

Symbol	Definition
	Symbol used to identify an ELECTRICAL HAZARD.
	Symbol used to identify a GENERIC HAZARD.

Tab. 3.12.

HAZARD!

It is absolutely forbidden to remove the safety pictograms on the device.

The user is obliged to replace safety pictograms which, as a result of wear and tear, removal or tampering are illegible (contact for this PIETRO FIORENTINI S.p.A.).

3.6 - NOISE LEVEL

VS/AM 65 is a safety device that does not entail the flow of gas inside under normal system operating conditions. For the value of the noise generated by the device and further information, contact PIETRO FIORENTINI S.p.A.

ATTENTION!

The obligation to use earmuffs or ear plugs to protect the hearing of qualified professional figures (reference paragraph 2.10) remains in the event that the noise in the installation environment of the device (depending on specific operating conditions) exceeds the value of 85 dBA.

4 - DESCRIPTION AND OPERATION

4.1 - GENERAL DESCRIPTION

The relief valves in the VS/AM 65 series are safety devices suitable for:

- pre-purified gaseous fluids;
- medium and low pressure systems.

The main elements of the device are:

Pos.	Description	Pos.	Description
1	Diaphragm	6	Seat
2	Setting spring	7	Diaphragm protection disc
3	Cover	8	Body
4	Cap	9	Plug
5	Adjustment ring nut	-	-

Tab. 4.13.

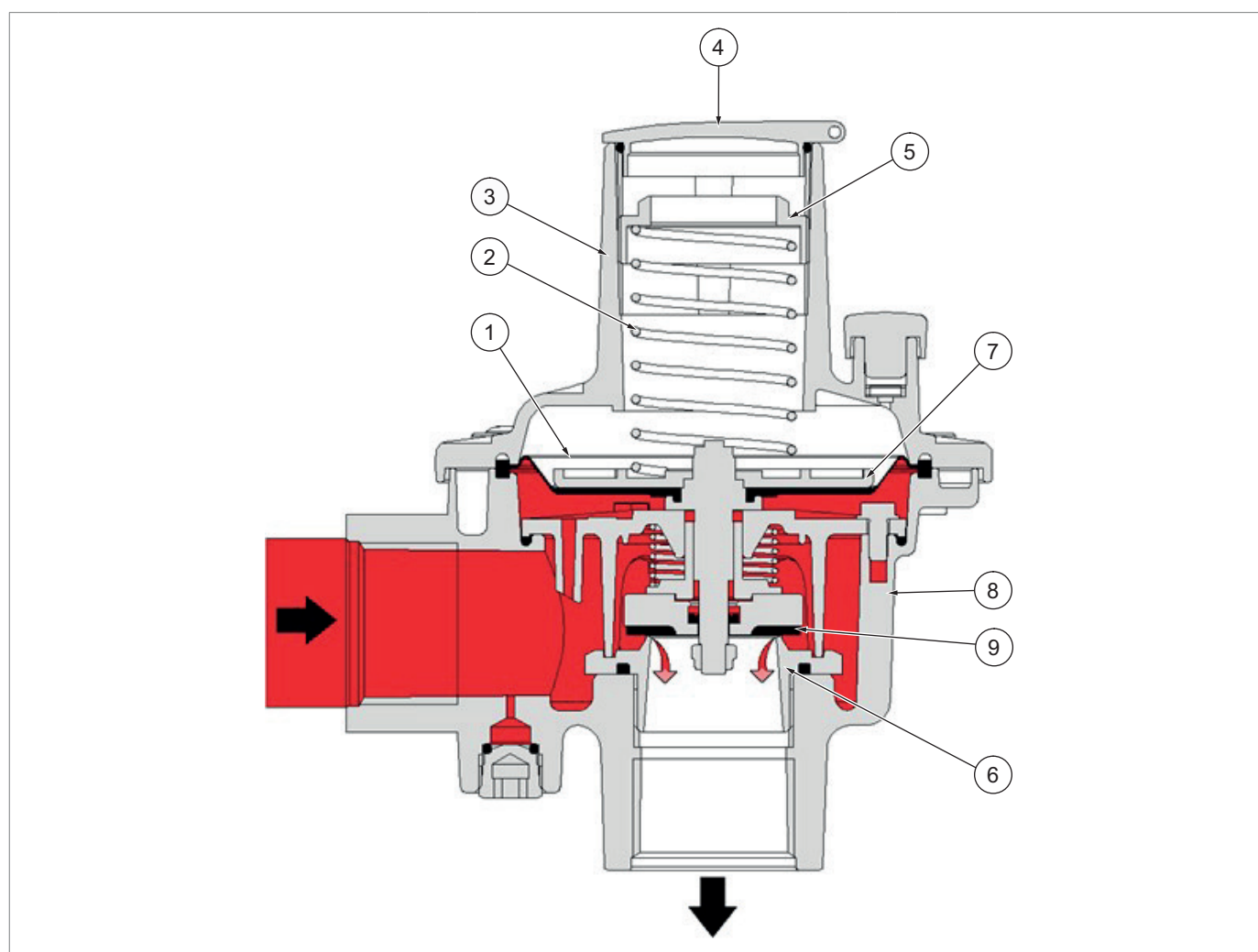

 INLET/OUTLET PRESSURE

Fig. 4.2. General description VS/AM 65 (basic version)

4.2 - OPERATION

! NOTICE!

Activation of the VS/AM 65 relief valve involves no external control sources other than the fluid itself.

The relief valves in the VS/AM 65 series are safety devices that:

- may be installed either on ducts or on pressure vessels;
- discharge a certain amount of gas outside when the pressure at the control point exceeds the calibration value due to short-term events, such as for example, closing of the shut-off valves for a very short amount of time and/or over-heating of gas with required flow rate zero.

The operating principle is based on the comparison between the thrust on the diaphragm (A) resulting from the upstream pressure (P_u) and the thrust resulting from the setting spring (B). The weight of the mobile unit and the static and dynamic residual thrusts on the plug (C) also affect this comparison.

When the thrust resulting from gas pressure:

- exceeds that of the setting spring, the plug (C) is raised, resulting in a certain amount of gas being discharged;
- drops below the calibration value, the plug re-closes.

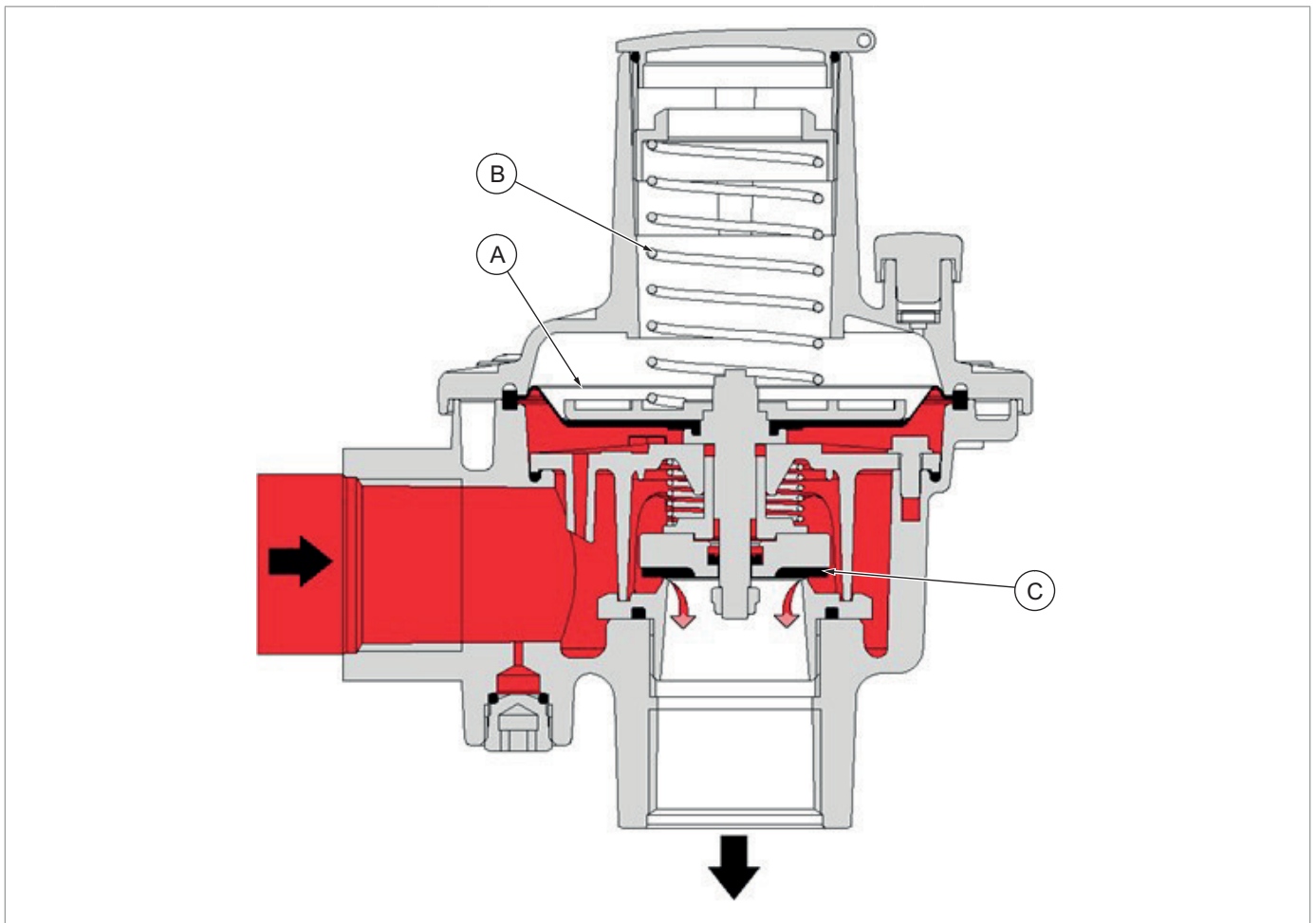

 INLET/OUTLET PRESSURE

Fig. 4.3. Operation VS/AM 65

4.3 - INTENDED USE

4.3.1 - ENVISAGED USE

This device is intended for:

Operation	Permitted	Unpermitted	Work environment
Discharge of excess pressure for:	Distribution systems for gaseous, non-aggressive or corrosive fluids, previously filtered.	<ul style="list-style-type: none"> Liquids. Any product other than those permitted. 	Installations for the distribution of natural gas to supply networks for: <ul style="list-style-type: none"> commercial use; home use.

Tab. 4.14.

The device referred to was designed to be used exclusively within the limits specified on the nameplate and according to the instructions and limits of use specified in this manual.

Safe work parameters are:

- use within the limits stated on the nameplate and in this manual;
- compliance with the procedures in the manual;
- routine maintenance to be carried out when and how recommended;
- special maintenance to be carried out if required;
- do not tamper with and/or bypass the safety devices.

4.3.2 - REASONABLY FORESEEABLE MISUSE

Incorrect and reasonably foreseeable use means the use of the device in a way not foreseen in the phase but which can result from readily foreseeable human behaviour:

- use of the device with corrosive fluids;
- use of the device with fluids that have not been properly treated upstream;
- use of the device with liquids;
- instinctive reaction of an operator in the event of a malfunction, accident or breakdown while using the device;
- behaviour resulting from pressure to keep the machine running under all circumstances;
- behaviour resulting from carelessness;
- behaviour resulting from the use of the device by unqualified and unfit persons (children, disabled persons);
- using the device in a manner other than that referred to under "Intended use".

Any use of the device other than the intended use must be previously approved in writing by PIETRO FIORENTINI S.p.A. If no written approval is provided, use shall be considered improper.

In the event of "improper use", PIETRO FIORENTINI S.p.A. shall not be held liable for any damage caused to people or property, and any type of warranty on the device shall be deemed void.

4.3.3 - TYPES OF FLUIDS

The device works with combustible gases used:

- in pressure control stations according to UNI EN 12186:2014 and UNI EN 12279:2007 standards, or in installations carrying LPG;
- in commercial premises and industrial plants (after checking by contacting PIETRO FIORENTINI S.p.A.).

NOTICE!

The device may be also used with inert gases, subject to verification by contacting the manufacturer.





4.4 - MODELS AND CONFIGURATIONS

The device models differ according to the adjustment range as shown in Tab. 4.15.:

Model name	Adjustment range
BP	15 - 150 mbar
MP	150 - 500 mbar
TR	500 - 7000 mbar

Tab. 4.15.

Other configurations can be set up according to inlet/outlet connections, as shown in Tab. 4.16.:

Type	Image
STANDARD	
WITH FITTINGS	
WITH SLIDING FLANGE	
WITH SLIDING FLANGES	

Tab. 4.16.

4.5 - TECHNICAL FEATURES/PERFORMANCE

The main technical features of the device are listed in Tab. 4.17:

Technical features	
Design pressure	20 bar
Calibration adjustment range	Version BP: 15 - 150 mbar MP version: 150 - 500 mbar TR Version: 500 - 7000 mbar
Accuracy class	up to 2.5 (depending on output pressure range)
Operating ambient temperature	Minimum: - 20°C Maximum: + 60°C

Tab. 4.17.

PAGE INTENTIONALLY LEFT BLANK

5 - TRANSPORT AND HANDLING



5.1 - SPECIFIC WARNINGS FOR TRANSPORT AND HANDLING

NOTICE!

Transport and handling must be carried out in compliance with the regulations in force in the country of installation by personnel who are:

- qualified (specially trained);
- who are familiar with accident prevention and workplace safety regulations;
- authorised to use lifting equipment.

Transport and handling

Operator qualification	<ul style="list-style-type: none"> • Installer.
PPE required	<div style="display: flex; align-items: center;">  </div> <div style="background-color: #f4a460; padding: 5px; margin-top: 5px;">  WARNING! </div> <p>The PPE listed in this table is related to the risk associated with the device. For the PPE required to protect against risks associated with the workplace, installation or operating conditions, please refer to:</p> <ul style="list-style-type: none"> • the regulations in force in the country of installation; • <u>any information provided by the Safety Manager at the installation facility.</u>
Weight and dimensions of the device	For dimensions and weights, please refer to section 5.2 'Physical characteristics of the device'.

Tab. 5.18.

5.1.1 - PACKAGING AND FASTENERS USED FOR TRANSPORT

The transport packaging is designed and manufactured to avoid damage during normal transport, storage and handling. The device must be kept in its packaging until installation.

Upon receipt of the device, it is necessary to:

- make sure that no part has been damaged during transport and/or handling;
- immediately report any damage found to PIETRO FIORENTINI S.p.A..

NOTICE!

PIETRO FIORENTINI S.p.A. shall not be liable for any damage to people or property caused by accidents due to failure to comply with the instructions provided in this manual.

Tab. 5.19. describes the types of packaging used:

Ref.	Type of packaging	Image
A	Single cardboard box	

Tab. 5.19.

5.2 - PACKAGING CONTENT

The packaging contains:

Description of content

VS/AM 65 gas meter including:

- relief valve;
- installation instructions.

NOTICE!

The technical manual can be downloaded from the manufacturer's website: <https://www.fiorentini.com>

Tab. 5.20.

5.3 - PHYSICAL CHARACTERISTICS OF THE DEVICE

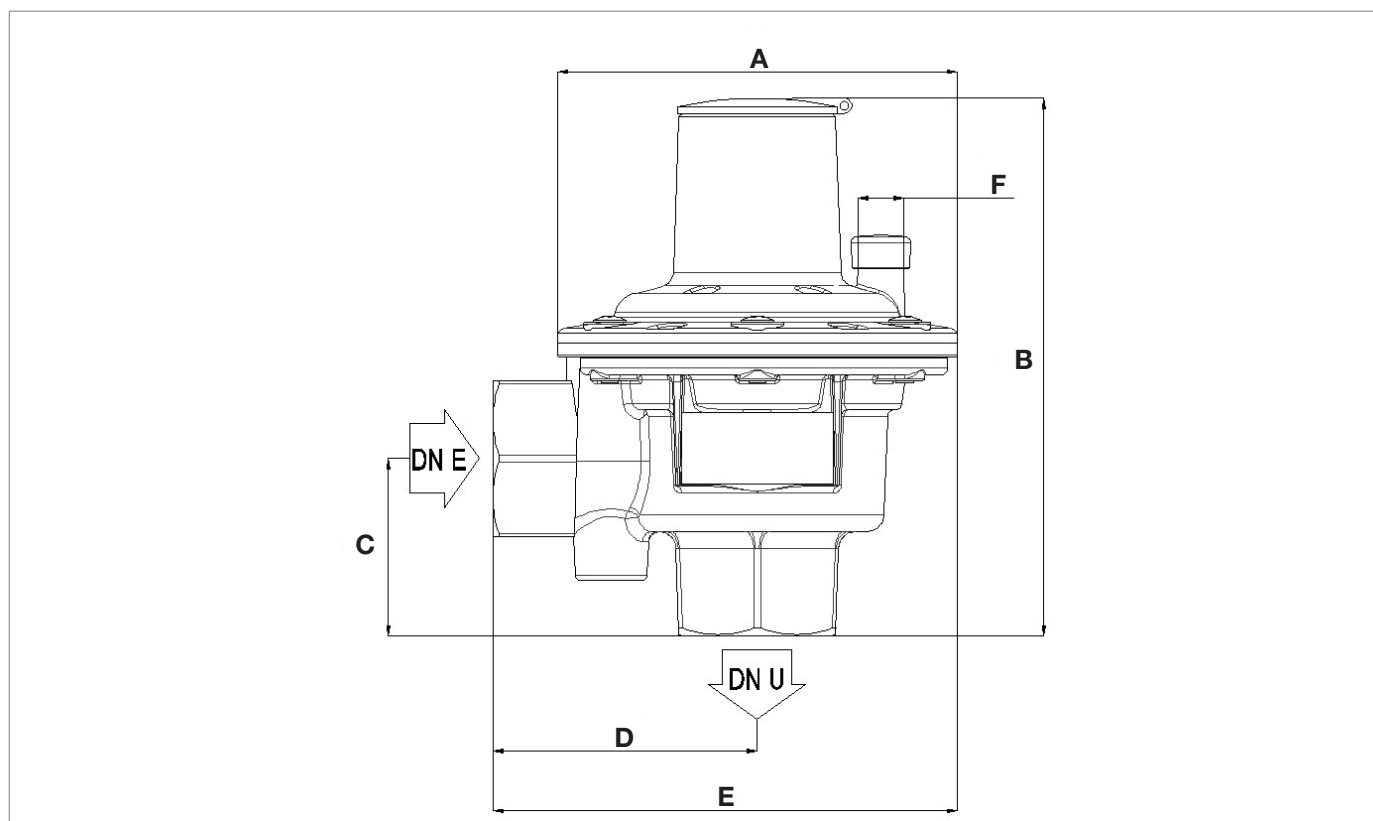

Fig. 5.4. VS/AM 65 physical characteristics

Overall dimensions	
Ref.	Dimensions [mm]
A	115
B	155
C	51
D	76
E	134
F	Rp 1/8
DN	25 x 25
NPS	1" x 1"

Tab. 5.21.

Weights [kg]	
Without packaging	0,9 kg
Including packaging	1 kg

Tab. 5.22.

! NOTICE!

Please refer to the product configurator ("sizing") at PIETRO FIORENTINI S.p.A. for equipment dimensions and weights.

5.4 - DEVICE ANCHORING AND LIFTING METHOD

HAZARD!

Using lifting equipment (if necessary) for unloading, carrying and handling packages is reserved only for skilled operators who have been properly trained (and are appropriately qualified if required by the regulations in force in the country of installation) and are familiar with:

- accident prevention rules;
- workplace safety provisions;
- lifting equipment features and limits.

HAZARD!

Before handling a load, make sure that its weight does not exceed the load capacity of the lifting equipment (and any other lifting tools) specified on the specific plate.

ATTENTION!

Before handling the device:

- remove any movable or hanging component or firmly secure it to the load;
- protect fragile equipment;
- check that the load is stable;
- make sure to have perfect visibility along the route.

5.4.1 - FORKLIFT HANDLING METHOD

HAZARD!

It is forbidden to:

- Do not transit under suspended loads;
- Do not move the load over the personnel operating in the site/plant area.

WARNING!

The following is not allowed on forklifts:

- carrying passengers;
- lifting people.

If cardboard boxes (single or multiple) are carried on a pallet, proceed as indicated in Tab. 5.23.:

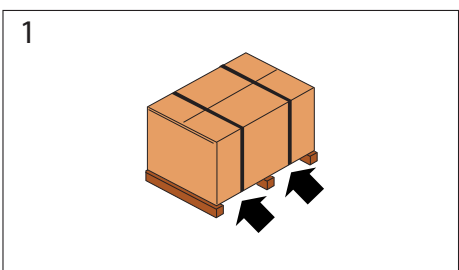
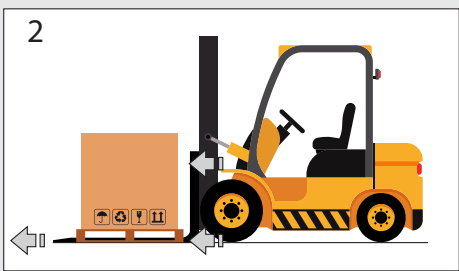
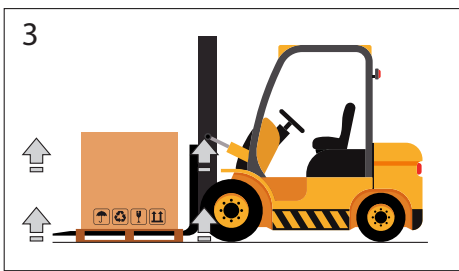
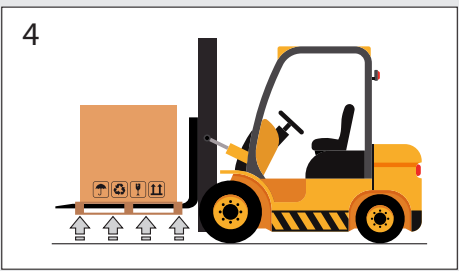
Step	Action	Image
1	Place the forks of the forklift under the load surface.	
2	Make sure that the forks protrude from the front of the load (by at least 5 cm), far enough to eliminate any risk of the transported load tipping.	
3	<p>Raise the forks until they are touching the load.</p> <div style="border: 1px solid #00a68f; padding: 5px; margin-top: 10px;"> <p>NOTICE! Fasten the load to the forks with clamps or similar devices if required.</p> </div>	
4	Slowly lift the load by a few dozen centimetres and check its stability, making sure that the centre of gravity of the load is at the centre of the lifting forks.	

Step	Action	Image
5	Tilt the mast backwards (towards the driver's seat) to help the over-turning moment and to ensure greater load stability during transport.	
6	Adjust transport speed according to the type of floor and load, avoiding sudden manoeuvres. ⚠ WARNING! In case of: <ul style="list-style-type: none"> • obstacles along the path; • particular operating situations; hinder operator visibility, the assistance of a ground operator is required, standing outside the range of action of the lifting equipment, with the task of signalling.	-
7	Place the load in the chosen installation area.	-

Tab. 5.23.

5.5 - PACKAGING REMOVAL

Packaging removal	
Operator qualification	<ul style="list-style-type: none"> Installer.
PPE required	<div style="display: flex; align-items: center;">  </div> <div style="background-color: #f4a460; padding: 5px; margin-top: 5px;"> <p>! WARNING!</p> </div> <p>The PPE listed in this table is related to the risk associated with the device. For the PPE necessary to protect against risks associated with the workplace or operating conditions, please refer to:</p> <ul style="list-style-type: none"> the regulations in force in the country of installation; <u>any information provided by the Safety Manager at the installation facility.</u>

Tab. 5.24.

To unpack the cardboard boxes (single or multiple) supported by a pallet, proceed as described in Tab. 5.25.:

Step	Action
1	Remove the stretch film around the pallet.
2	Remove the 4 support corners.
3	<p>Move the boxes of the equipment from the pallet to their intended place.</p> <div style="border: 1px solid #0070c0; padding: 5px; margin-top: 5px;"> <p>! NOTICE!</p> <p>Have at least 2 operators manually move the packages if required due to their dimensions/weight.</p> </div>

Tab. 5.25.

! NOTICE!

After removing all packaging materials, check for any anomalies.
If there are anomalies:

- do not install the equipment;
- contact PIETRO FIORENTINI S.p.A. and specify the details provided on the device nameplate.

! WARNING!

The individual device is contained in a specially designed cardboard box.
Avoid taking the device out of the box before its installation.

5.5.1 - PACKAGING DISPOSAL

! NOTICE!

Sort the various materials making up the packaging and dispose of them in compliance with the regulations in force in the country of installation.

5.6 - STORAGE AND ENVIRONMENTAL CONDITIONS

WARNING!

Protect the regulator from blows and impacts, even accidental, until it is installed.

The following table shows the minimum environmental conditions to be expected should the device be stored for an extended period.

Compliance with these conditions will guarantee the declared performance:

Conditions	Data
Maximum storage period	5 years.
Temperature	Not above 40°C
Relative humidity	Not above 70%
Radiation and light sources	Away from radiation and light sources according to UNI ISO 2230:2009

Tab. 5.26.

5.6.1 - STORAGE LASTING LONGER THAN THE MAXIMUM TIME ALLOWED

NOTICE!

After a storage period exceeding the maximum time allowed (5 years), the device must be scrapped.

6 - INSTALLATION

6.1 - INSTALLATION PRE-REQUISITES

6.1.1 - ALLOWED ENVIRONMENTAL CONDITIONS

WARNING!

To safely use the device, in full respect of the allowed environmental conditions, follow the data shown on the regulator plate and on any accessories (refer to paragraph 2.8 “Nameplates applied”).

WARNING!

The device must be installed away from atmospheric agents and direct sunlight.

The installation site must be suitable for the safe use of the device.

The installation area of the device must be properly lit to ensure proper operator visibility during working on the device.

NOTICE!

The device must operate in places that are properly lit by artificial lighting suitable for the protection of the operator (in compliance with UNI EN 12464-1:2011 and UNI EN 12464-2:2014). If work is to be performed in areas and/or parts that are poorly lit, it is mandatory to:

- use the light sources of the installation plant;
- be equipped with a handheld lighting system or connected to the power mains, compliant with Directive 2014/34/EU (ATEX) for use in environments at risk of explosion.

6.1.2 - STORAGE LASTING LONGER THAN THE MAXIMUM TIME ALLOWED

WARNING!

It is forbidden to install the device after a storage period exceeding the maximum permitted (5 years).

After a storage period longer than the maximum permitted, the device must be scrapped.

6.1.3 - CHECKS BEFORE INSTALLATION

The device does not require any further upstream safety device for protection against any overpressure with respect to its **PS admissible pressure** when, for the upstream reduction station, the maximum incidental downstream pressure is:

$$\text{MIPd} \leq 1.1 \text{ PS}$$

MIPd = Maximum incidental downstream pressure value (for further information, see UNI EN 12186:2014).

WARNING!

Identify the model of the device by means of the applied identification plate (see section 2.8) and ensure that the data on it agrees with the required performance.

ATTENTION!

The installer must use fittings and gaskets recommended by the manufacturer.

If the installation of the device requires the application of compression fittings, these must be installed in accordance with the instructions of the Manufacturer of the fittings themselves.

The choice of fittings must be compatible with:

- **use for a specific device;**
- **the plant specifications when required.**

Before installation, it must be ensured that:

- the installation is constructed in accordance with the standards in force and in any case according to good engineering practice;
- the device has not been damaged during transport;
- the intended installation compartment meets the provisions in force on safety and is away from any possible damage of mechanical origin, away from sources of heat or naked flames, in a dry place and protected from external agents;
- the device can be inserted in the space provided (see section 5.3 'Physical characteristics of the device');
- there are no obstructions that could hinder installation operations and the future maintenance operations;
- the inlet and outlet pipes are at the same level and able to support the weight of the device (see section 5.3 "Physical characteristics of the device");
- on the input/output connections are totally free of mechanical stress;
- the pipe inlet/outlet connections are parallel and clean;
- the inlet piping has been cleaned in order to expel residual impurities such as welding slag, sand, paint residues, water, etc.

6.2 - SPECIFIC SAFETY INSTRUCTIONS FOR THE INSTALLATION STEP

WARNING!

Before proceeding with installation, make sure that the upstream and downstream valves installed on the line are shut off.

WARNING!

Installation may also take place in areas where there is a risk of explosion, which implies that all necessary prevention and protection measures have to be taken.

For these measures, please refer to the regulations in force at the place of installation.

WARNING!

In the vicinity of the device it is prohibited to:

- use open flames (e.g. for welding operations);
- smoke.

WARNING!

When installing the device:

- in closed rooms, all body and cover drains must be connected and led to the outside;
- outdoors, it must be protected from the weather and direct sunlight.

WARNING!

The device is designed to operate under atmospheric backpressure (backpressure = 0).

It is the responsibility of the system designer to correctly dimension the discharge line downstream of the device in accordance with the design conditions.

WARNING!

The installer must use fittings and gaskets recommended by PIETRO FIORENTINI S.p.A.

WARNING!

In order to avoid breakage or unwanted deformation, it is necessary to:

- install the device according to current standards;
- that there are no external loads bearing on the device;
- do not use the device as a template (can be supplied on request);
- to provide the device with appropriate protective means and earthing against stray currents and potential electrostatic differentials;
- use the device within the limits indicated on the identification plates attached to it (see section 2.8 of the manual).

6.3 - POSSIBLE INSTALLATIONS OF THE DEVICE

! NOTICE!



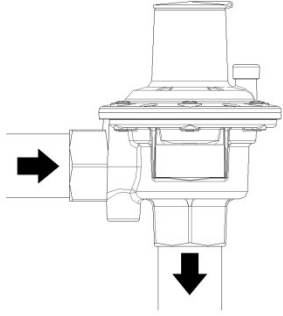
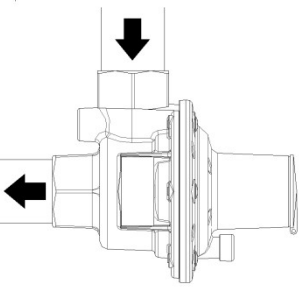
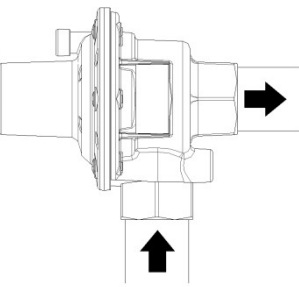

- With natural gas or other non-corrosive gases that are not subject to recondensation, the device can be installed in any flow direction.
- Please avoid any mounting positions with outlet flow facing upwards in installations using LPG.

For information about how to mount the device in keeping with the available models and configurations, refer to Tab. 6.27.:

Flow direction	Installation position	Installation requirements in the presence of recondensation phenomena
Square horizontal flow		<p>! WARNING!</p> <p>The vents on the device do not drain condensate. Installation is only possible if there is no condensation (e.g. between the cover and the diaphragm).</p>
Square vertical flow		<p>! NOTICE!</p> <p>In this position, the vents on the regulator allow for the evacuation of condensate.</p>
Square reverse vertical flow		<p>! WARNING!</p> <p>The vents on the device do not drain condensate. Installation is only possible if there is no condensation (e.g. between the cover and the diaphragm).</p>

Tab. 6.27.

6.4 - INSTALLATION PROCEDURE

Installation	
Operator qualification	<ul style="list-style-type: none"> Installer.
PPE required	<div style="display: flex; align-items: center; gap: 10px;">      </div> <div style="background-color: #f4a460; padding: 5px; margin-top: 5px;"> ⚠ WARNING! </div> <p>The PPE listed in this table is related to the risk associated with the device. For the PPE required to protect against risks associated with the workplace, installation or operating conditions, please refer to:</p> <ul style="list-style-type: none"> the regulations in force in the country of installation; <u>any information provided by the Safety Manager at the installation facility.</u>
Equipment required	Refer to Chapter 7 'Commissioning/maintenance equipment'.

Tab. 6.28.

The device must be installed on the line with the arrow on the body pointing in the direction of gas flow.

⚠ WARNING!

Install the device taking into consideration that the direction of flow is required and is indicated with an arrow on the body of the device itself.

! NOTICE!

Clean the pipes before installing the device.

6.4.1 - DEVICE INSTALLATION PROCEDURE

To install the equipment in line, proceed as specified in Tab. 6. 29.:

Step	Action
1	Apply the checks in paragraph 6.1.3 (“Checks before installation”).
2	Remove all packaging/protection of the device (if any). <div style="border: 1px solid black; padding: 5px; margin-top: 5px;">  NOTICE! For proper disposal of packaging, please refer to the regulations in force in the country where the equipment is installed. </div>
3	Position the device in the section of the line intended for it.
4	Make the connection, following the diagram below.
5	Check that the inlet/outlet shut-off valves, the bypass valve, if any, and the air vent valve are closed.

Tab. 6.29.

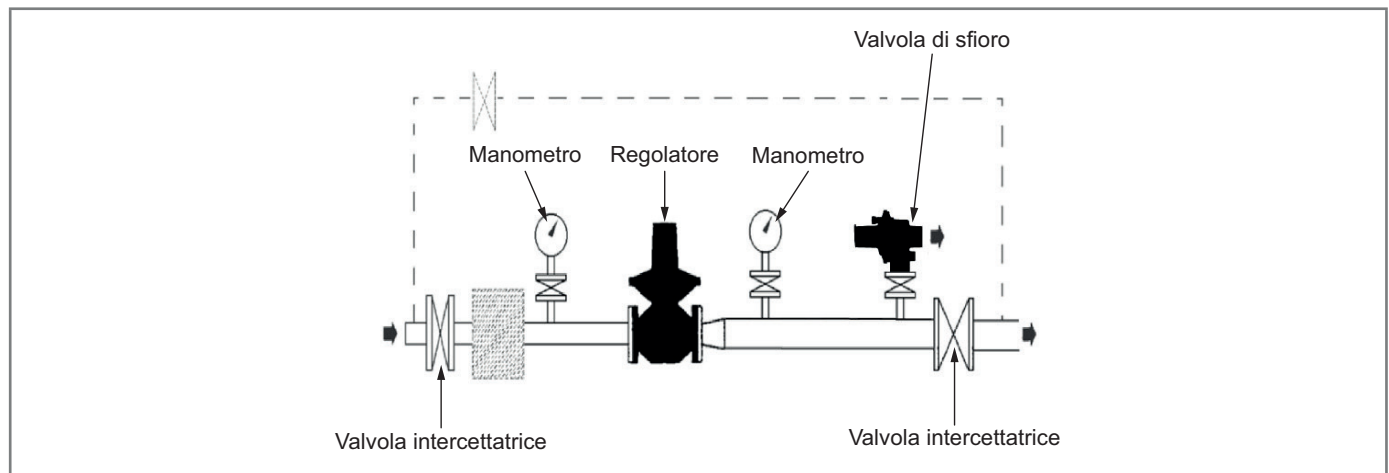

Fig. 6.5. Installation scheme

NOTICE!

The warranty shall be deemed null and void and PIETRO FIORENTINI S.p.A. shall not be held liable for any damage and/or malfunctions if the fittings used during installation are not those supplied.

6.5 - POST-INSTALLATION CHECKS

To perform the post-installation check, proceed as shown in Tab. 6.30.:

Step	Action
1	Sprinkle the device and its connections to the system with a foaming solution or similar.
2	Open the shut-off valve at the inlet of the device very slowly.
3	Check the tightness of the internal and external surfaces of the device, verifying that the foaming solution does not change in the form of swelling or bubbles.

Tab. 6.30.

WARNING!

Protect the device from blows and shocks, even accidental ones, until commissioning.



7 - COMMISSIONING/MAINTENANCE EQUIPMENT

7.1 - LIST OF EQUIPMENT

Use of commissioning/maintenance equipment	
Operator qualification	<ul style="list-style-type: none"> Name of the user. Specialised technician.
PPE required	<div style="display: flex; align-items: center;">  </div> <div style="background-color: #f4a460; padding: 5px; margin-top: 5px;"> <p>⚠ WARNING!</p> </div> <p>The PPE listed in this table is related to the risk associated with the device. For the PPE required to protect against risks associated with the workplace, installation or operating conditions, please refer to:</p> <ul style="list-style-type: none"> the regulations in force in the country of installation; <u>any information provided by the Safety Manager at the installation facility.</u>

Tab. 7.31.

We list the types of equipment required for commissioning and maintenance of the regulator:

Ref.	Equipment type	Image
A	Double ended bi-hex tubular socket wrench: <ul style="list-style-type: none"> CH 7 CH 27 	
B	Allen key: <ul style="list-style-type: none"> CH 6 CH 8 	
C	Torx T20 screwdriver	

Tab. 7.32.

PAGE INTENTIONALLY LEFT BLANK

8 - COMMISSIONING

8.1 - GENERAL WARNINGS

8.1.1 - SAFETY REQUIREMENTS FOR COMMISSIONING

 **HAZARD!**

During commissioning the risks associated with any discharges to the atmosphere of flammable or noxious gases must be evaluated.

 **HAZARD!**

In case of installation on distribution networks for natural gas, consider the risk associated with explosive mixtures (gas/air) being formed inside the piping, if the line is not subjected to inerting.

 **WARNING!**

During commissioning, any unauthorised personnel must keep away.

 **WARNING!**

Before commissioning the device, it is necessary to check that all shut-off valves (inlet, outlet, bypass if any) are closed.

 **NOTICE!**

Commissioning has to be carried out by authorised and qualified personnel.

8.2 - PRELIMINARY PROCEDURES FOR COMMISSIONING

HAZARD!

Before commissioning the device, it is mandatory to ensure that any source of explosion or ignition has been eliminated.

WARNING!

Before commissioning, it must be ensured that:

- the conditions of use comply with the characteristics of the device;
- carry out the checks described in section 6.5 "Post-installation checks";
- check that all shut-off valves (inlet, outlet and by-pass, if any) are closed and that the gas is at a temperature that does not cause malfunctions.

ATTENTION!

To protect the device from damage, never:

- pressurise the device through a valve located downstream of it;
- depressurise the device through a valve located upstream of it.

8.3 - DEVICE CALIBRATION

WARNING!

Do not tamper with or make any unauthorised changes to the device without the approval of PIETRO FIORENTINI S.p.A.





ATTENTION!

Observe the spring calibration ranges given in the tables in Chapter 10 ('Calibration tables').

NOTICE!

The device is regulated at the PIETRO FIORENTINI S.p.A. production facilities
Check calibrations according to the procedures outlined in the following paragraphs.

8.4 - DEVICE COMMISSIONING PROCEDURE

Commissioning	
Operator qualification	<ul style="list-style-type: none"> User/specialist technician.
PPE required	<div style="display: flex; align-items: center;">      </div> <div style="background-color: #f4a460; padding: 5px; margin-top: 5px;"> <p>⚠ WARNING!</p> </div> <p>The PPE listed in this table is related to the risk associated with the device. For the PPE required to protect against risks associated with the workplace, installation or operating conditions, please refer to:</p> <ul style="list-style-type: none"> the regulations in force in the country of installation; <u>any information provided by the Safety Manager at the installation facility.</u>
Equipment required	Refer to Chapter 7 'Commissioning/maintenance equipment'.

Tab. 8.33.

NOTICE!

For systems consisting of two lines, it is recommended to commission one line at a time, starting with the one with the lower setting, so called “reserve”.

Commissioning takes place by direct insertion of the gas into the pipes, keeping the speed of the gas inside the pipes as low as possible (maximum permitted speed of 5 m/s) in 2 modes depending on the interposition of an in-line shut-off valve.

8.4.1 - COMMISSIONING WITHOUT SHUT-OFF VALVE

When the device is installed directly on the line, i.e. without the interposition of a shut-off valve, proceed as shown in Tab. 8.34:

Step	Action
1	Ensure that the outlet shut-off valve (V2) and the air vent valve (6) are closed.
2	Connect a controlled auxiliary pressure to the cock (6) and stabilise it at the desired cut-in value.
3	Open the air vent valve (6) resulting in a pressure increase in the outlet.
4	Check that the device (15) trips. <div style="border: 1px solid blue; padding: 5px; margin-top: 5px;"> <p>NOTICE! For pressure adjustments, see section 8.5 'Device adjustments'.</p> </div>

Tab. 8.34.

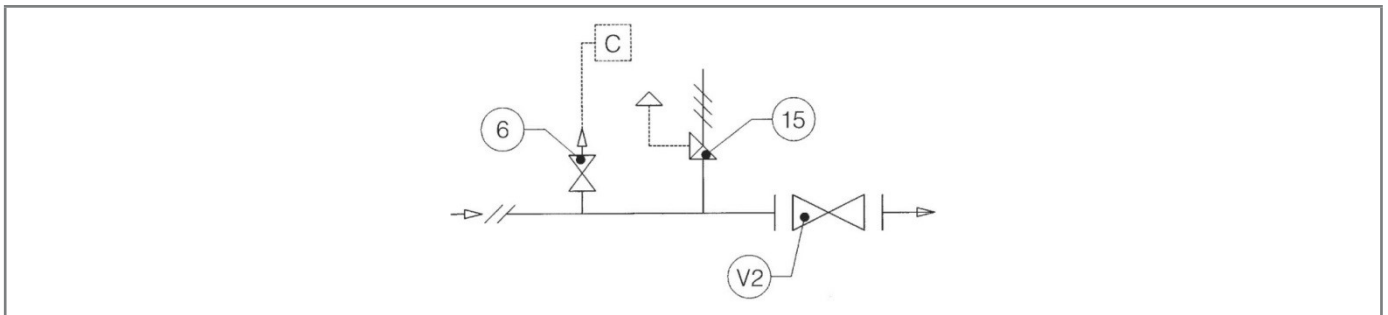

Fig. 8.6. Direct connection on the line

8.4.2 - COMMISSIONING WITH SHUT-OFF VALVE

When the device is installed with a shut-off valve in between, proceed as shown in Tab. 8.35:

Step	Action
1	Close the shut-off valve (16).
2	Connect a controlled auxiliary pressure to the port (17) and increase it slowly up to the set tripping value.
3	Check that the device (15) trips. <div style="border: 1px solid blue; padding: 5px; margin-top: 5px;"> <p>NOTICE! For pressure adjustments, see section 8.5 'Device adjustments'.</p> </div>

Tab. 8.35.

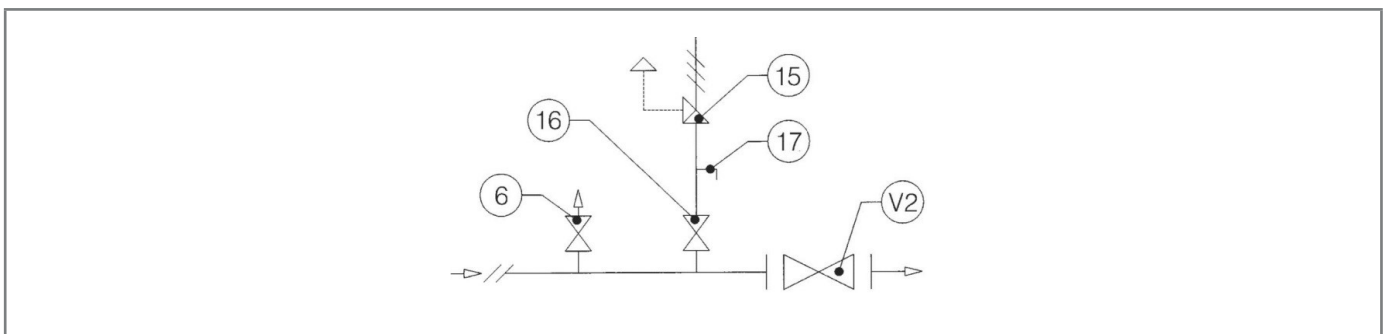

Fig. 8.7. Connection with shut-off valve



8.5 - DEVICE SETTINGS

NOTICE!

All devices are calibrated to the values requested by the customer directly at PIETRO FIORENTINI S.p.A. factory

The calibration values are specified on the nameplate (refer to paragraph 2.8 “Applied rating plates”). It is forbidden to make unauthorised changes to the device.

Adjustment

Operator qualification	<ul style="list-style-type: none"> User/specialist technician.
PPE required	<div style="display: flex; align-items: center;">  </div> <div style="background-color: #f4a460; padding: 5px; margin-top: 5px;">  WARNING! </div> <p>The PPE listed in this table is related to the risk associated with the device. For the PPE required to protect against risks associated with the workplace, installation or operating conditions, please refer to:</p> <ul style="list-style-type: none"> the regulations in force in the country of installation; any information provided by the Safety Manager at the installation facility.
Equipment required	Refer to Chapter 7 'Commissioning/maintenance equipment'.

Tab. 8.36.

WARNING!

Minor $\pm 10\%$ calibration changes with respect to the nameplate value (see paragraph 2.8 “Applied rating plates”) can be made only by adhering to the spring ranges specified in the tables in chapter 13 (“Calibration tables”).

Contact PIETRO FIORENTINI S.p.A. for any further need.

If it is necessary to adjust the tripping pressure of the relief valve, proceed as shown in Tab.8.37:

Step	Action	Necessary equipment
1	Unscrew the top cap (A).	-
2	Turn the ring nut (B): <ul style="list-style-type: none"> • clockwise to increase tripping pressure; • anti-clockwise to decrease the tripping pressure. 	27 mm tubular socket wrench
3	Screw in the upper cap (A) when the adjustment is complete.	-

Tab. 8.37.

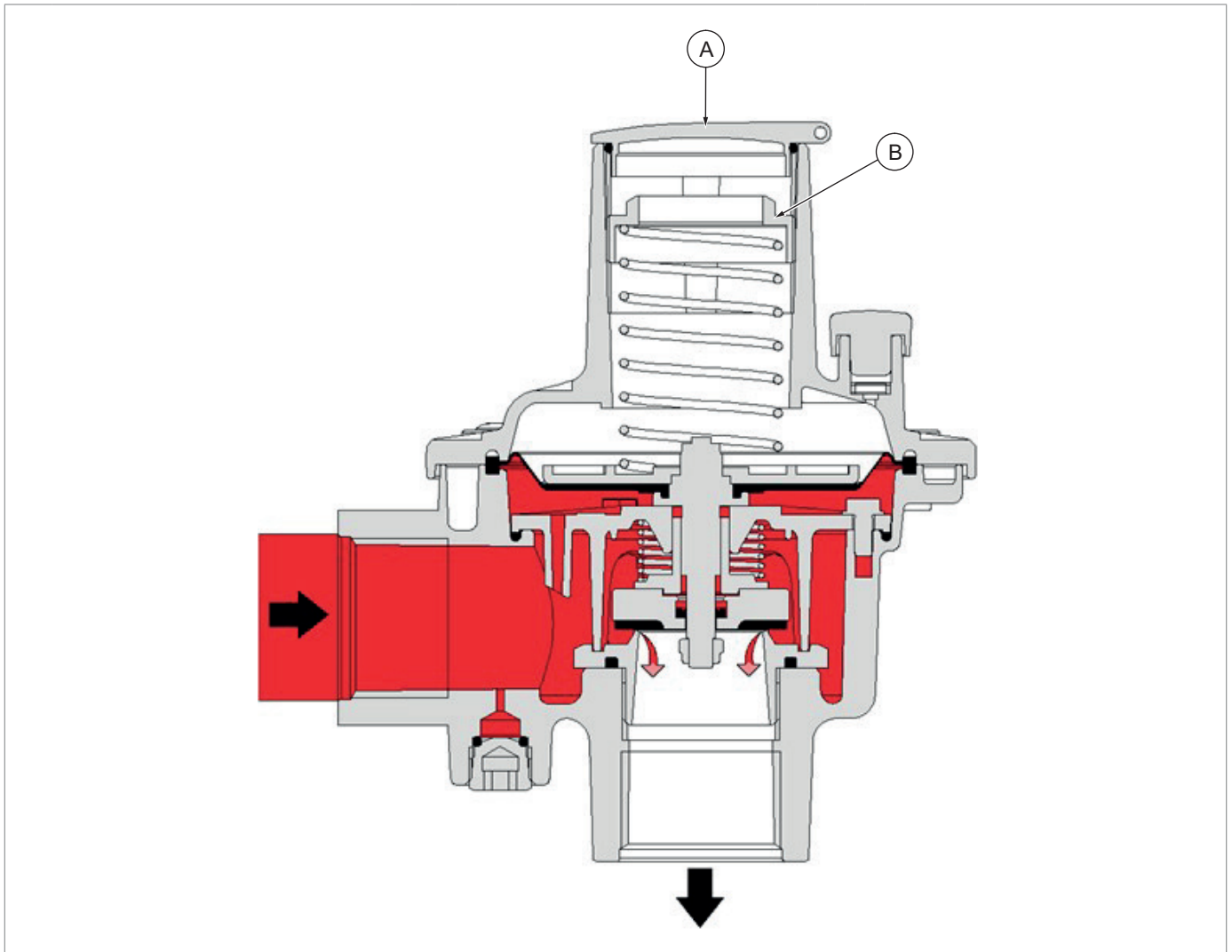

 INLET/OUTLET PRESSURE

Fig. 8.8. Adjustments VS/AM 65

9 - MAINTENANCE AND FUNCTIONAL CHECKS

9.1 - GENERAL WARNINGS

HAZARD!

- Maintenance work must be carried out by qualified personnel trained on safety in the workplace and authorised to carry out device-related activities.
- Repair or maintenance work not provided for in this manual may be carried out only if approved by PIETRO FIORENTINI S.p.A.. PIETRO FIORENTINI S.p.A. shall not be held liable for damage to persons or property resulting from operations other than those described herein or carried out in ways other than as indicated.

WARNING!

Before conducting any work, make sure that the line on which the device is installed:

- has been shut off downstream and upstream;
- has been discharged.

WARNING!

When depressurising the system for maintenance operations, care must be taken to ensure that the vents to the outlets are in a safe area.

To avoid the risk of spark generation due to the impact of impurity particles within the discharge lines, it is recommended to maintain a fluid velocity of less than 5 m/sec.

WARNING!

In case of doubt, do not perform any work. Contact PIETRO FIORENTINI S.p.A. for the necessary clarifications.

The management and/or use of the device includes interventions that are necessary as a result of normal use such as:

- inspection and checks;
- functional checks;
- routine maintenance;
- special maintenance.

NOTICE!

Maintenance work is strictly related to:

- the quality of the conveyed gas (impurities, humidity, gasoline, corrosive substances);
- the state of cleanliness and preservation of the pipes upstream of the device;
- the level of reliability required of the installation;
- to the conditions of use of the device.

Good device management requires:

- follow the service frequency referred to in the manual for functional checks and routine maintenance.
- not exceed the time interval between one service and the next. The time interval is to be understood as the maximum acceptable; it can, however, be shortened;
- promptly check the causes of any anomalies such as excessive noise, leakage of fluids or similar and remedy them. The timely removal of any causes of anomaly and/or malfunction prevents further damage to the equipment and ensures operator safety;

Before beginning disassembly of the device, make sure that:

- the spare parts and parts used in replacements have adequate requirements to ensure the original performance of the device. Use recommended original spare parts;
- the operator has the necessary equipment (see chapter 7 “Equipment for commissioning/maintenance”).

 **NOTICE!**

The recommended spare parts are unambiguously identified with tags indicating:

- **the assembly drawing number of the device where they are installed (see Chapter 12 “Recommended spare parts”);**
- **the position specified in the assembly drawing of the device.**

The device maintenance operations are divided, from an operational point of view, into three main categories:

Commissioning and maintenance operations	
Periodic checks and inspections	All those checks that the operator must carry out on a regular basis to ensure that the device is in proper working order.
Routine maintenance	All those operations that the operator must preventively carry out to ensure proper operation of the device over time. Routine maintenance includes: <ul style="list-style-type: none"> • inspection; • control; • adjustment; • cleaning; • lubrication; • replacement of all spare parts.
Special maintenance	<p>All those operations to be carried out by the operator when the device requires them.</p> <div style="background-color: #c00000; color: white; padding: 5px; display: flex; align-items: center;">  HAZARD! </div> <p>Special maintenance:</p> <ul style="list-style-type: none"> • requires extensive and specialised knowledge of the machines, operations required, risks involved and correct procedures to operate safely; • must be provided by qualified, trained and authorised technicians.



Tab. 9.38.

9.2 - PERIODICALLY CHECKING AND INSPECTING THE EQUIPMENT FOR PROPER OPERATION

HAZARD!

Checks and inspections are only carried out by authorised technicians after notification to the manufacturer.

Periodic checks and inspections

Operator qualification	<ul style="list-style-type: none"> User/specialist technician.
PPE required	<div style="display: flex; align-items: center;">  </div> <div style="background-color: #f4a460; padding: 5px; margin-top: 5px;">  WARNING! </div> <p>The PPE listed in this table is related to the risk associated with the device. For the PPE required to protect against risks associated with the workplace, installation or operating conditions, please refer to:</p> <ul style="list-style-type: none"> the regulations in force in the country of installation; any information provided by the Safety Manager at the installation facility.
Equipment required	Refer to Chapter 7 'Commissioning/maintenance equipment'.

Tab. 9.39.

Activity description	Evaluation criterion	Minimum frequency
Visual inspection of external state of device	<ul style="list-style-type: none"> No visible damage. External surface protection as per UNI 9571-1:2012. 	Half-yearly
Leak testing (see paragraph 9.2.1)	<ul style="list-style-type: none"> No release of gas to the atmosphere. 	If needed

Tab. 9.40.

9.2.1 - LEAK TESTING

To check the tightness of the device, proceed as shown in Tab. 9.41.:

Step	Action
1	Sprinkle the device and its connections to the system with a foaming solution or similar.
2	Open the shut-off valve located at the inlet of the device very slowly.
3	Check the tightness of the internal and external surfaces of the device by verifying that the foaming solution does not change in the form of swelling or bubbles.

Tab. 9.41.

9.3 - ROUTINE MAINTENANCE

9.3.1 - GENERAL SAFETY WARNINGS

HAZARD!

- Put the device in a safe condition (close the downstream and then the upstream shut-off valve, drain the device completely and lastly drain the line);
- Ensure that the pressure upstream and downstream of the device is “0”.

NOTICE!

Before installing new sealing elements (o-rings, diaphragm, etc.), they must be checked for integrity.

9.3.2 - REPLACEMENT FREQUENCY FOR COMPONENTS SUBJECT TO WEAR

NOTICE!

The following provisions shall apply to device components only.

The non-metallic parts of the equipment concerned are divided into the following two categories:

Preventive maintenance work

Category 1	Covers parts subject to wear and/or abrasion, where: <ul style="list-style-type: none"> • wear and tear means the normal degradation of a part after prolonged use under normal operating conditions; • abrasion is the mechanical action on the surface of the affected part resulting from the passage of gas under normal operating conditions.
Category 2	takes into account parts subject to aging only, including parts that also require lubrication and/or cleaning.

Tab. 9.42.

NOTICE!





Check the state of wear/abrasion/ageing of the components present within the minimum frequency indicated in the table below.

Category	Part description	Evaluation criterion	Minimum replacement frequency
1	Sealing rings for non-metallic valve seats and plugs.	Pressure regulators	6 years
		Safety devices	
		Pressure safety system equipment	
1	Non-metallic parts with internal sealing function of valve seats and accessories of individual equipment.	Pilots	6 years
		Pre-regulators	
		Accelerators	
1	Non-metallic parts with a sealing function between parts, at least one of which is in motion under normal working/operating conditions.	Any others	6 years
		Pressure regulators	
		Gas flow slam-shut type safety devices	
		Relief devices with discharge to atmosphere	

Category	Part description	Evaluation criterion	Minimum replacement frequency
1	Non-metallic parts with sealing function involved in disassembly operations during maintenance.	Equipment subject to maintenance	6 years
2	Non-metallic parts providing feedback (sensing elements) of the controlled pressure of safety equipment.	Safety equipment and/or accessories	6 years
2	Non-metallic parts with sealing and performance functions (diaphragms).	Pressure regulators and accessories	6 years
		Gas flow slam-shut type safety devices	6 years
		Relief device with discharge to atmosphere	6 years
2	Non-metallic parts of equipment with an internal sealing function: under normal operating conditions during maintenance.	Relief valves	6 years
		Regulation lines disconnection equipment	If there are proven leaks
2	Non-metallic parts with a static sealing function only.	Various equipment	If there are proven leaks
2	Lubricating parts.	Shut-off valves	Yearly
		Other equipment	Yearly
2	Filter elements.	Filters	As needed

Tab. 9.43.

9.4 - ROUTINE MAINTENANCE PROCEDURES

Routine maintenance	
Operator qualification	<ul style="list-style-type: none"> User/specialist technician.
PPE required	<div style="display: flex; align-items: center;">      </div> <p>WARNING!</p> <p>The PPE listed in this table is related to the risk associated with the device. For the PPE required to protect against risks associated with the workplace, installation or operating conditions, please refer to:</p> <ul style="list-style-type: none"> the regulations in force in the country of installation; <u>any information provided by the Safety Manager at the installation facility.</u>
Equipment required	Refer to Chapter 7 'Commissioning/maintenance equipment'.

Tab. 9.44.

9.4.1 - PRELIMINARY OPERATIONS

HAZARD!

- Put the device in a safe condition (close the downstream and then the upstream shut-off valve, drain the device completely and lastly drain the line);
- Ensure that the pressure upstream and downstream of the device is "0".

9.4.2 - DISASSEMBLY/REASSEMBLY

NOTICE!

Make reference marks, before disassembly, on parts of the device which may present orientation or mutual positioning problems during reassembly.

WARNING!

Handle the internal components of the device with extreme care in order not to damage them. If any components are damaged during disassembly and reassembly, replace them.

PAGE INTENTIONALLY LEFT BLANK

TESTATA TR

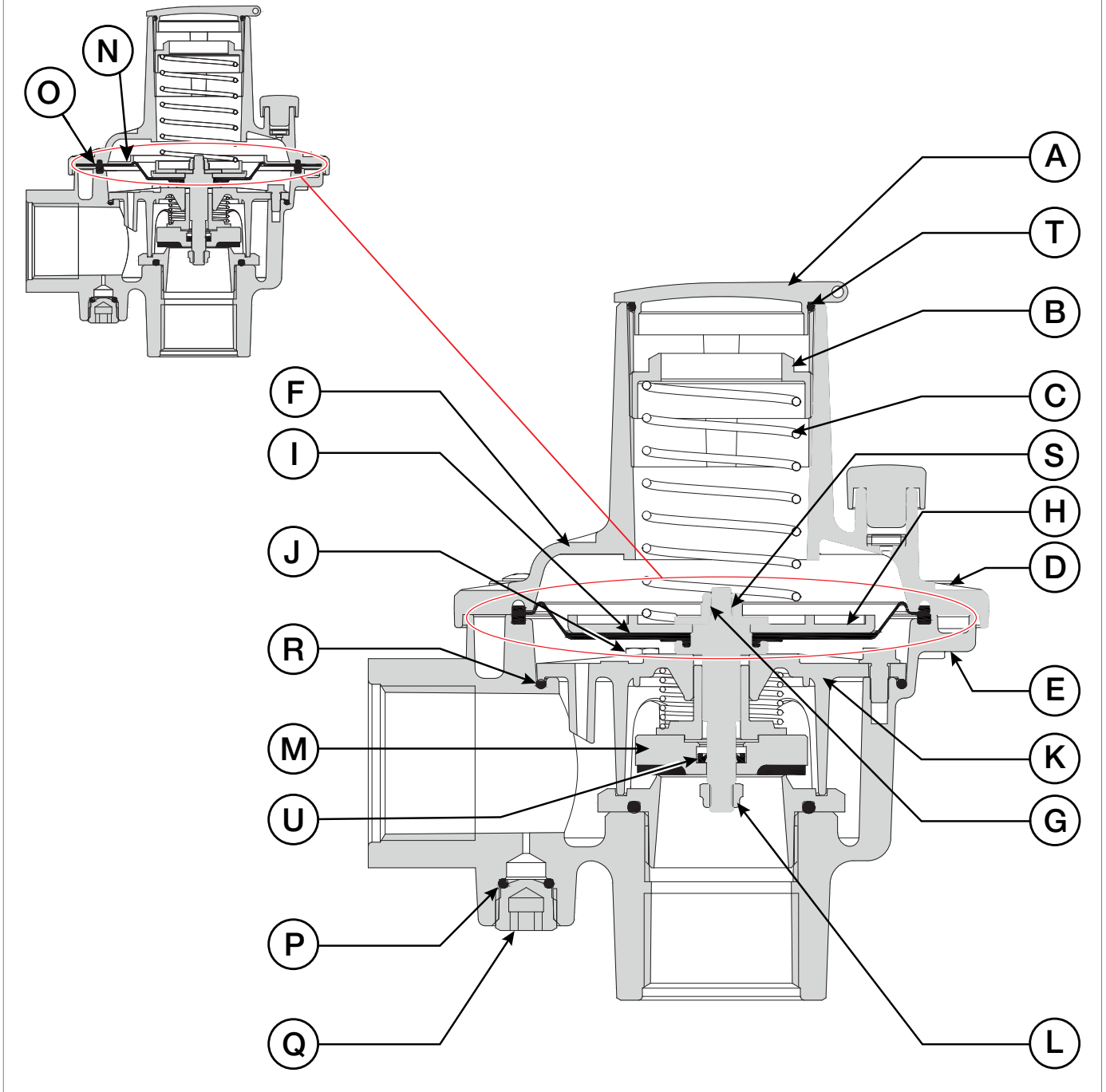

! NOTICE!



The maintenance procedure described in Tab. 9.45 is valid for all models listed in section 2.2 (Tab. 2.3.). Any differences between models are explained in the specific step of the maintenance procedure.

To service the internal components of the relief valve, proceed as shown in Tab. 9.45.:

Step	Action
1	Unscrew and remove the cap (A).
2	Unscrew and remove the ring nut (B). Equipment required: tubular socket wrench CH 27.
3	Remove the spring (C).
4	Unscrew and remove the screws (D) together with the nuts (E). Equipment required: T20 torx screwdriver.
5	Remove the top cover (F).
6	STEP ONLY VALID FOR VERSION TR: Remove the reduction disc (N) and the O-ring (O).
7	Unscrew and remove the nut (G) together with the washer (S). Equipment required: spanner CH 8. ! NOTICE! During this step, hold the diaphragm protection disc (H) in place.
8	Remove the diaphragm protection disc (H).
9	Remove the diaphragm (I).
10	Unscrew and remove the screws (J) from the plug guide assembly (K). Equipment required: tubular socket wrench CH 7.
11	Remove the plug guide assembly (K).
12	Unscrew and remove the nut (L). Equipment required: spanner CH 8. ! NOTICE! During this step, hold the plug (M) still.
13	Remove the plug (M).
14	Unscrew and remove the cap (Q). Required equipment: spanner CH 6.
15	Remove and replace O-ring (P), lubricating it with silicone grease. ! NOTICE! Before inserting the replacement O-ring, clean the retaining slots with a non-aggressive cleaning solution.
16	Insert and secure the cap (Q). Required equipment: spanner CH 6.
17	Remove and replace O-ring (R), lubricating it with silicone grease. ! NOTICE! Before inserting the replacement O-ring, clean the retaining slots with a non-aggressive cleaning solution.

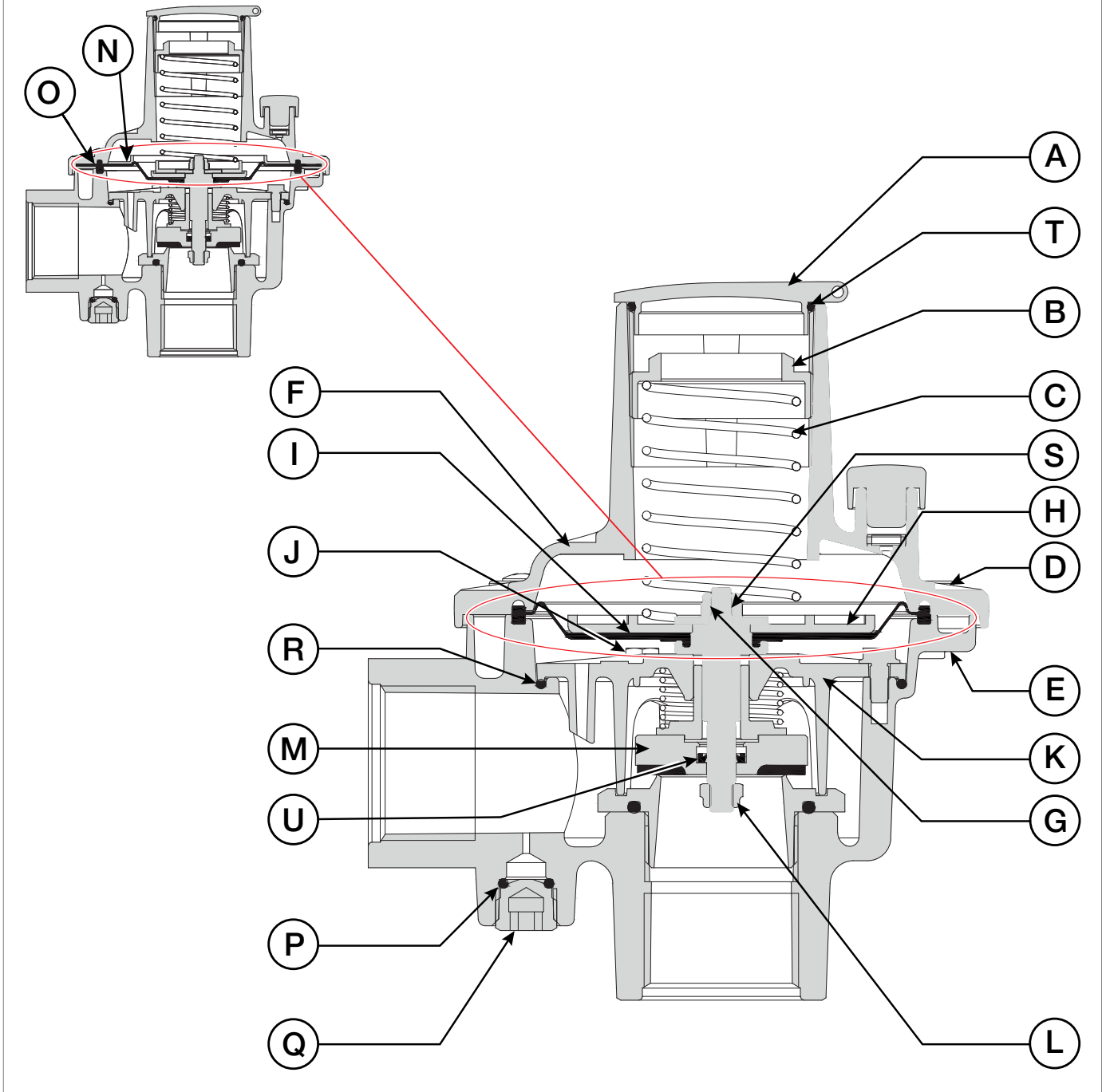
TESTATA TR



Step	Action
18	Remove the 'U' ring (U) from the plug (M).
19	Lubricate the 'U' ring (U) and reinsert it into the plug (M).
20	Assemble the plug guide assembly (K).
21	<p>Insert and secure the nut (L).</p> <p>Equipment required: spanner CH 8.</p> <div style="border: 1px solid blue; padding: 5px;"> <p> NOTICE!</p> <p>During this step, hold the plug (M) still.</p> </div>
22	Insert and fasten screws (J).
23	Fit the diaphragm (I).
24	Fit the diaphragm protection disc (H).
25	Insert the washer (S).
26	<p>Insert and secure the nut (G).</p> <p>Equipment required: spanner CH 8.</p> <div style="border: 1px solid blue; padding: 5px;"> <p> NOTICE!</p> <p>During this step, hold the diaphragm protection disc (H) in place.</p> </div>
27	Position the upper cover (F).
28	<p>STEP ONLY VALID FOR VERSION TR:</p> <p>Replace the O-ring (O) removed in Step 6 and insert the reduction disc (N).</p>
29	<p>Insert and fasten the screws (D) together with the nuts (E).</p> <p>Equipment required: T20 torx screwdriver.</p>
30	Insert the spring (C).
31	<p>Insert the ring nut (B).</p> <p>Equipment required: tubular socket wrench CH 27.</p>
32	<p>Remove and replace O-ring (T), lubricating it with silicone grease.</p> <div style="border: 1px solid blue; padding: 5px;"> <p> NOTICE!</p> <p>Before inserting the replacement O-ring, clean the retaining slots with a non-aggressive cleaning solution.</p> </div>
33	Insert and secure the cap (A).

Tab. 9.45.

 **WARNING!**

The external tightness of the device must be verified by means of a plug leak test:

- before putting back into service;
- at an adequate pressure to ensure that there are no external leaks (refer to section 6.5 'Post-installation checks').

PAGE INTENTIONALLY LEFT BLANK

10 - TROUBLESHOOTING

Below is a list of the cases (causes and services) that may occur over time in the form of malfunctions of various kinds. These situations depend on the conditions of the gas as well as on the natural ageing and wear of the materials.

10.1 - GENERAL WARNINGS

HAZARD!

Troubleshooting operations must be carried out by personnel:

- trained on workplace safety also based on the regulations in force in the place of installation of the device;
- qualified and authorised to carry out activities related to the device.

WARNING!

PIETRO FIORENTINI S.p.A. shall not be held liable for any damage to people and property due to services:

- other than those described;
- performed according to methods other than those specified;
- carried out by unsuitable personnel.

NOTICE!

Please call the Service Centre Authorised by PIETRO FIORENTINI S.p.A. if, in the event of a malfunction, you do not have the necessary qualified personnel for the specific intervention.

10.2 - OPERATOR QUALIFICATION SPECIFICATION

Troubleshooting	
Operator qualification	<ul style="list-style-type: none"> User/specialist technician.
PPE required	<div style="display: flex; align-items: center;">  </div> <div style="background-color: #f4a460; padding: 5px; margin-top: 5px;"> ⚠ WARNING! </div> <p>The PPE listed in this table is related to the risk associated with the device. For the PPE required to protect against risks associated with the workplace, installation or operating conditions, please refer to:</p> <ul style="list-style-type: none"> the regulations in force in the country of installation; <u>any information provided by the Safety Manager at the installation facility.</u>
Equipment required	Refer to Chapter 7 'Commissioning/maintenance equipment'.

Tab. 10.46.

10.3 - TROUBLESHOOTING PROCEDURES

For proper troubleshooting, proceed as follows:

- close the downstream shut-off valves;
- refer to the troubleshooting tables listed below.

10.4 - TROUBLESHOOTING TABLE

Failure	Possible causes	Intervention
Failed sealing	Valve seat damaged.	Complete valve replacement.
	Damaged plug.	Replacement.
	Damaged O-rings.	Replacement.
	Damaged membrane.	Replacement.
	Filth or foreign bodies in sealing area.	Cleaning.

Tab. 10.47.

11 - UNINSTALLATION AND DISPOSAL

11.1 - GENERAL SAFETY WARNINGS

HAZARD!



Make sure that there are no potentially explosive ignition sources in the work area set up to uninstall and/or dispose of the device.

WARNING!

Before proceeding with uninstallation and disposal, make the device safe by disconnecting it from any power supply.

11.2 - QUALIFICATION OF THE OPERATORS IN CHARGE

Commissioning

Operator qualification	<ul style="list-style-type: none"> Installer.
PPE required	<div style="display: flex; align-items: center;">  </div> <div style="background-color: #f9a825; padding: 5px; margin-top: 5px;">  WARNING! </div> <p>The PPE listed in this table is related to the risk associated with the device. For the PPE required to protect against risks associated with the workplace, installation or operating conditions, please refer to:</p> <ul style="list-style-type: none"> the regulations in force in the country of installation; any information provided by the Safety Manager at the installation facility.
Equipment required	Refer to Chapter 7 'Commissioning/maintenance equipment'.

Tab. 11.48.

11.3 - UNINSTALLATION

ATTENTION!

Before uninstalling the device, completely drain the fluid in the reduction line and inside the device itself.

For proper uninstallation, proceed as shown in Tab. 11.49.:

Step	Action
1	Close the valves upstream and downstream of the device.
2	Disconnect the upstream and downstream pipes from the device by unscrewing the fittings with adequate hand tools.
3	Remove the device. <div style="border: 1px solid blue; padding: 5px; margin-top: 5px;">  NOTICE! </div> <p>Seal the valves upstream and downstream of the device in the case of:</p> <ul style="list-style-type: none"> closing the system; non-immediate replacement of the device.

Tab. 11.49.

11.4 - INFORMATION REQUIRED IN CASE OF RE-INSTALLATION

NOTICE!

Should the device be reused after uninstallation, refer to chapters:

- “Installation”;
- “Commissioning”.

11.5 - DISPOSAL INFORMATION

NOTICE!

- **Proper disposal prevents damage to humans and the environment and promotes the reuse of precious raw materials.**
- **Bear in mind that the regulations in force in the country of installation must be complied with.**
- **Illegal or improper disposal involves the application of the penalties provided for by the regulations in force in the country of installation.**

The device is made of materials that can be recycled by specialised companies.
For proper disposal of the device, proceed as specified in Tab. 11.50:

Step	Action
1	Prepare a large, clutter-free work area for safe dismantling operations.
2	Sort the various components by type of material for easier recycling through separate collection.
3	Send the materials obtained in Step 2 to a specialised company.

Tab. 11.50.

The device in any configuration consists of the materials described in Tab.11.50.:

Material	Disposal/recycling indications
Plastic	It must be dismantled and disposed of separately.
Lubricants/Oils	They must be collected and delivered to the appropriate specialised and authorised collection and disposal centres.
Steel	Disassemble and collect separately. It must be recycled through the specific collection centres.
Stainless steel	Disassemble and collect separately. It must be recycled through the specific collection centres.
Aluminium	Disassemble and collect separately. It must be recycled through the specific collection centres.
Pneumatic/electric components	They must be dismantled in order to be reused if they are still in good condition or, if possible, overhauled and recycled.

Tab. 11.51.

NOTICE!

The above materials refer to standard versions. Different materials can be provided for specific needs.

NOTICE!

Refer to chapter 9 “Maintenance and functional checks” to better identify the composition of the device and its parts.

12 - RECOMMENDED SPARE PARTS

12.1 - GENERAL WARNINGS

NOTICE!

If spare parts not marked are used, PIETRO FIORENTINI S.p.A. their declared performance cannot be guaranteed.

It is recommended to use original spare parts PIETRO FIORENTINI S.p.A.

PIETRO FIORENTINI S.p.A. shall not be held liable for any damage caused by using non-original parts.

12.2 - HOW TO REQUEST SPARE PARTS

NOTICE!

For specific information, please refer to the sales network of PIETRO FIORENTINI S.p.A.

PAGE INTENTIONALLY LEFT BLANK

13 - CALIBRATION TABLES

13.1 - CALIBRATION TABLES

NOTICE!

When the value indicated on the rating plate of the device is equal to the minimum or maximum value of a spring mentioned in the tables, the spring in the device is the one with the minimum range value equal to the calibration value on the rating plate.

VS/AM 65 BP SPRING FEATURES

Pos.	Spring item code	Spring colour	d	Lo	De	Setting field (mbar)	
						Min.	Max.
1	64470171ZB	WHITE	1.8	57	34	15	24
2	64470172NE	BLACK	2	54	34	25	44
3	64470131VE	GREEN	2.2	70	34	45	64
4	64470132RO	RED	2.4	67	34	65	99
5	64470133BL	BLUE	2.4	84	34	100	150

d = Wire Diameter (mm) Lo = Spring Length (mm) De = External Diameter (mm)

Tab. 13.52.

VS/AM 65 MP SPRING FEATURES

Pos.	Spring item code	Spring colour	d	Lo	De	Setting field (mbar)	
						Min.	Max.
1	64470135GI	YELLOW	3.2	63	34	150	299
2	64470136GR	GREY	3.5	69	34	300	500

d = Wire Diameter (mm) Lo = Spring Length (mm) De = External Diameter (mm)

Tab. 13.53.

VS/AM 65 TR SPRING FEATURES

Pos.	Spring item code	Spring colour	d	Lo	De	Setting field (mbar)	
						Min.	Max.
1	64470135GI	YELLOW	3.2	63	34	500	819
2	64470203VE	GREEN	4	64	34	820	2299
3	64470165ZB	WHITE	5	64	34	2300	4999
4	64470309AR	ORANGE	5.5	60	34	5000	7000

d = Wire Diameter (mm) Lo = Spring Length (mm) De = External Diameter (mm)

Tab. 13.54.

TM0050ENG

