

RSE

SAMGAS

Smart GAS meter

RSE/2001 LA – RSE/2,4



Use and Maintenance Manual
Point to Point Version (PP)

Rev. 10	Date 03/02/2016
------------	--------------------

Index

1.	Introduction	5
1.1.	Identification of the product	5
1.2.	Packaging content	6
2.	Safety instructions	7
2.1.	Electrostatic discharges	7
2.2.	Connecting to other devices.....	7
2.3.	Feeding devices	7
2.4.	Safety instructions for installation in the hazardous area.....	8
3.	General description	8
4.	Main functions	10
4.1.	On-off valve	10
4.1.1.	Procedure for opening the valve through the user interface	10
4.2.	Digital outputs	10
4.3.	Data recording	10
4.4.	Acquisition	11
4.5.	Events and diagnostics	11
4.6.	Activation.....	11
4.7.	Communication	11
4.8.	User interface	12
5.	Installation	12
5.1.	Mechanics installation.....	12
5.2.	Connection to the system.....	13
5.2.1.	Using the ZVEI probe	13
5.3.	Power supply	14
5.3.1.	Connecting the batteries	14
5.3.2.	Supply status.....	14
5.4.	Security and fraud prevention.....	15
6.	User interface	16
6.1.	Keyboard.....	16
6.2.	Display	16
6.2.1.	Display testing capabilities	16
6.2.2.	Menu field	17

6.2.3.	Units of measurement field	17
6.2.4.	Numeric field	18
6.2.5.	Icons and alarms field	18
7.	Menu structure	19
7.1.	Chapters.....	19
7.1.1.	Totalizer of volumes under reference conditions in the current billing period	19
7.1.2.	Totalizer of volumes subject to alarm in the current billing period	19
7.1.3.	Totalizer of volumes for price range 1 in the current billing period	20
7.1.4.	Totalizer of volumes for price range 2 in the current billing period	20
7.1.5.	Totalizer of volumes for price range 3 in the current billing period	20
7.1.6.	Totalizer of volumes under reference conditions in the previous billing period	20
7.1.7.	Totalizer of volumes subject to alarm in the previous billing period	20
7.1.8.	Totalizer of volumes for price range 1 in the previous billing period	21
7.1.9.	Totalizer of volumes for price range 2 in the previous billing period	21
7.1.10.	Totalizer of volumes for price range 3 in the previous billing period	21
7.1.11.	Invoice date	21
7.1.12.	Diagnostics.....	22
7.1.13.	User Message	22
7.1.14.	Redelivery Point (PDR) ID	23
7.1.15.	Status of the valve	23
7.1.16.	Status of the device	24
7.1.16.1.	Enabling and disabling of the ZVEI port.....	25
7.1.16.2.	Enabling and disabling of the counting for the test phase.....	26
7.1.17.	Maximum conventional flow rate	27
7.1.18.	Date	28
7.1.19.	Time	29
7.1.20.	Current rate	29
8.	Configuration	30
9.	Maintenance	30
9.1.	Ordinary maintenance.....	30
9.1.1.	Replacing the batteries.....	30
9.1.2.	SIM Replacement.....	31
9.1.3.	Firmware update	31

9.2.	Device replacement and disposal.....	31
10.	Technical characteristics	32
10.1.	General features	32
10.2.	Communication ports	33
10.3.	Feeding devices	33

1. Introduction

RSE is a family of products dedicated to measuring gas volume, which involves the application in end points of redelivery of natural gas networks. This document refers to the versions RSE/2001 LA and RSE/2,4. The product incorporates a mechanical device for measuring the gas volumes based on the diaphragm metering technology with an electronic processor able to guarantee the functions provided by the resolution 631/2013/R/GAS issued by AEEGSI on 27/12/2013, as well as to allow the remote reading and remote control of the flow without the use of additional external devices. RSE meters are used in low pressure measuring systems (<0.5 bar gauge) with a flow rate lower than 10m³/h (class A2 according to the classification of UNITS 11291). This document provides information about the use of the involved device, with application starting from the firmware release LR 1.09 / NLR 1.31.

RSE/2001 LA and RSE/2,4 are available in different models with the following main common features:

- IP 55 protection;
- Integrated temperature sensor;
- Local optical communication port complying with CEI EN 62056-21 (ZVEI);
- LCD display;
- 3 front keys (user interface);

The various models differ in the following features:

- Type of modem:
 - Wireless M-Bus 169 Mhz mode-N;
 - 868 Mhz;
 - GPRS/GSM;

1.1. Identification of the product

The product can be identified by the metrological cover shown in **fig.1** positioned on the front of the device as shown in **fig.2**, which bears the following symbols and data:

- Type of model;
- Name of the logic device.

Type of model:

Code format **RSE/2001 LA; RSE/2,4**

Name of the logic device:

Format SMG-R-03-WV-YY-XXXXXX;
 SMG Fixed data indicating the manufacturer (Samgas Srl) according to the Flag Association coding;
 R Reserved;
 03 Type of device (GAS meter);
 W Type of caliber;
 V Type of communication
 YY Year of production;
 XXXXXX Serial number;

The forecast product versions are given here below:

Version Code "W"	Type of caliber
"1"	G 1.6
"2"	G 2.5
"4"	G 4
"6"	G 6

Version Code "V"	Type of communication
"0"	169 MHz
"1"	GSM
"2"	868 MHz

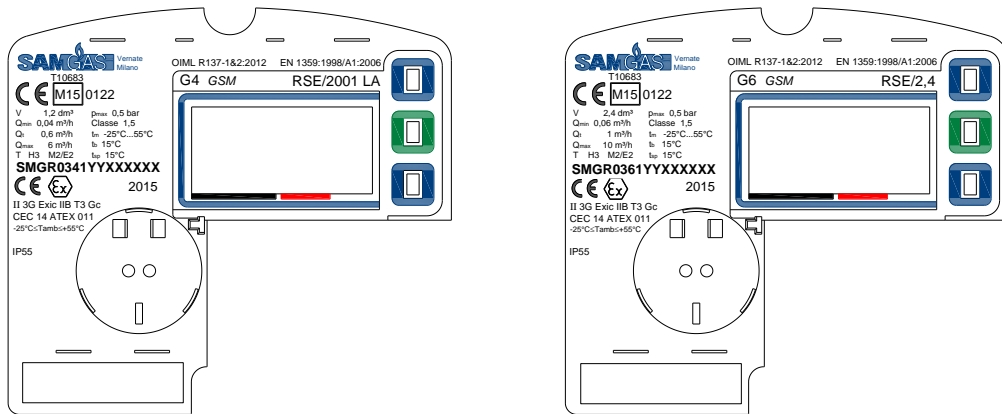

Fig.1



Fig. 2

1.2. Packaging content

The package contains the following parts:

Device

- RSE device including:
 - o Metrological battery;
 - o Communication battery, replaceable;
 - o Two plugs for the protection of the connection fittings;

The batteries are inside in their operation seat already electrically connected.

Manual

- User Manual:

The user manual and the use and maintenance manual are available for download on the website www.fiorentini.com

Certificates

The EC declaration of conformity shall be attached to the transport document of the instrument.

2. Safety instructions

RSE is an intrinsically safe device suitable for use in hazardous areas classified as Zone 2 Group IIB. The minimum installation category is ATEX Category II 3G. The harmonized CENELEC standards relevant to the compliance with the EHSR requirements (Essential Health and Safety Requirements) of the ATEX Directive are EN 60079-0 and EN 60079-11.

This device is designed to comply with the requirements of the type of protection Ex ic IIA T3 Gc, ambient temperature range -25°/55°C and ATEX category II 3G.

2.1. Electrostatic discharges

This device is approved for installation in areas with low explosion risk (risk only for short periods). In these areas, sparks produced from electrostatic discharges could generate explosions in extreme cases. Although during normal operation there is no presence of dangerous potentials on the device, the use of dissipative footwear and of a damp cloth (% > 65%) is recommended during the installation/maintenance. Further information can be found in CEI 50404.

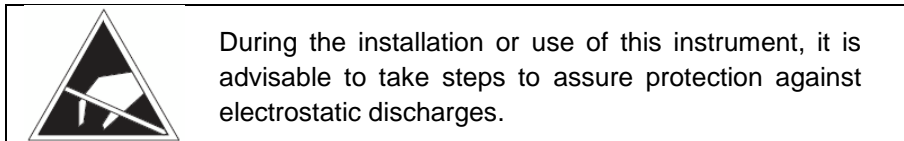

<p>Pietro Fiorentini SpA denies all liabilities resulting from the risks and consequences caused by the non-compliance with these provisions</p>
--

2.2. Connecting to other devices

There is no RSE connection with external devices.

RSE can connect, using the ZVEI optical port, to devices for the communication of data and commands useful for configuration and maintenance of the device.

RSE can connect, using the GSM modem/wireless radio port, to local and/or remote devices for the communication of the data and commands useful for configuration, management, and maintenance of the device.

2.3. Feeding devices

RSE can be powered exclusively by a special approved battery pack.

As a matter of fact, the battery pack is a proprietary assembly consisting of a lithium battery and a cable ending with a special connector, coated by a protective sheath.

The battery pack is a device certified for exclusive use with the RSE device and it is the only permissible power supply device.

<p>Caution! Use only batteries of the type and model complying with the original.</p>

The connector of the battery pack is polarized in such a way as to fit only in the connector specifically provided for on the device, observing the correct polarity.

The following data are given on the battery pack:

- Model;
- Maximum output levels;
- Week and year of production
- Quality pass upon acceptance

The metrological battery pack is sufficient to assure an autonomy of at least 15 years under the reference operating conditions specified in paragraph **Technical features**.

The transmission battery pack for the GSM module is sufficient to assure an autonomy of at least 8 years under the reference operating conditions specified in paragraph **Technical features**.

2.4. Safety instructions for installation in the hazardous area

This equipment has to be installed and operated in compliance with the provisions and regulations in force. The manufacturer cannot be liable for damages resulting from failure to follow instructions and inappropriate use.

Safety warning

All works must be performed by qualified personnel.

Transformation of spare parts

Any technical changes are forbidden. Use only original spare parts.

Transport

As a rule, meters shall be transported being kept in vertical position.

Upon receipt of the product, examine the supplied material.

Immediately notify any shipping damage.

Storage

As a rule, meters have to be stored in vertical position and in a dry place at ambient temperature.

WARNING

- Install in a compartment that meets the provisions in force on safety, away from any possible damage of mechanical origin, away from sources of heat or open flames, in a dry place and protected from external agents;
- Install with the indicator device in a horizontal position, not in contact with the wall and raised with respect to the floor;
- During installation, avoid mechanical stress to the inlet and outlet connections;
- The arrow on the top of the meter indicates the direction of the gas flow;
- The on/off valve, positioned in the system upstream of the meter, has to be opened in a gradual manner in order to make the gas flow homogeneously, without violent shocks that could damage the internal components of the meter;
- It is strictly forbidden to repair or make any modifications to the instrument;
- The installation, removal, and any works in general have to be performed by qualified personnel, in compliance with the provisions in force concerning safety.

3. General description

Figures 3 and 4 illustrate the structure and the main parts of the device.

The device consists of:

A metal enclosure containing in it:

- The mechanics for measuring the volumes complying with that of the RS/2001 meter;
- The flow on/off valve;
- The sensor for measuring gas temperature;
- The permanent memory device (see paragraph 4.3 data recording);

A plastic enclosure containing in it:

- The electronic measurement and communication card;
- The battery(batteries)

On the front of the plastic container there are:

- A segment and icon display;
- Three operator keys;
- Optical communication interface.



Fig.3 RSE/2001 LA View

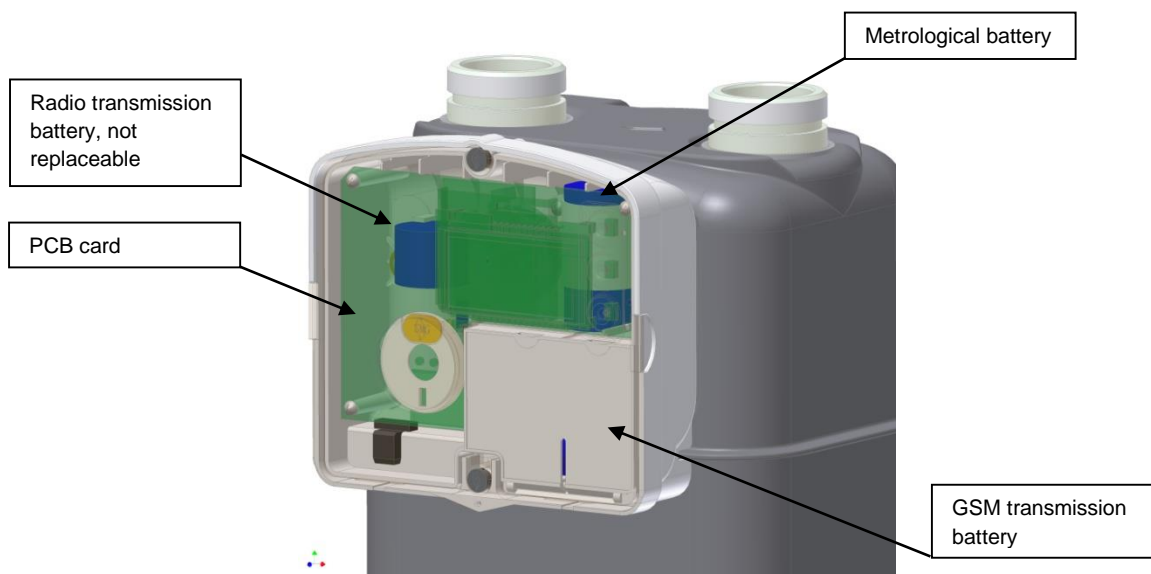

Fig. 4 - Meter internal view

RSE is a measuring instrument with accuracy class 1.5 or 1 (upon request), as defined in Directive 2004/22/EC (MID). RSE is able to count the amount of gas that has passed through the meter in different consumption ranges in relation to the time in which it was measured, in compliance with the provisions of the resolution 631/2013/R/GAS issued by AEEGSI on 27/12/2013.

4. Main functions

4.1. On-off valve

With reference to the standards of the series UNI/TS 11291, RSE implements in particular the following services:

UNI/TS 11291-1 4.3.4 Service: Supply management
UNI/TS 11291-6 6 Flow on/off

The gas flow on/off valve is located within the body of the meter into the inlet connection and is not accessible without causing permanent damage to the meter itself.

The purpose of the valve is to intercept the gas flow towards the user exclusively for the commercial purposes. **In no way or condition, the valve has to be considered and used as a useful device to assure safety conditions in the user's plant in case of possible or patent gas leakages.**

The valve is specifically designed to assure its performance and functioning for at least 15 years and it is able to provide the control microprocessor with the actual status of the valve (closed/open) and with information about its correct operation.

The valve can be closed:

- Due to a remote control sent via wireless communication channel (e.g.: from the SAC Remote Management Center);
- When changing the battery is not authorized;
- Due to a break-in attempted beyond the threshold;
- When there is no communication for a configurable time;
- When the residual battery power is below the critical level;
- In case of failure of the Gdm system.

The previously closed valve, can be opened **only locally** by activating the keyboard according to a special procedure (see chapter 4.1.1)

The opening of the previously closed valve must be authorized **in advance** by the SAC - Control Center.

It is possible to display the status of the valve in the related SV menu (see chapter 6 and chapter 7.1.18).

To reactivate a previously closed valve, RSE must have first of all received the "authorization for opening" from the Control Center.

4.1.1.Procedure for opening the valve through the user interface

After receiving permission for opening the valve from SAC, with a set time window useful to perform such operation and the maximum number of possible attempts, under the **SV** valve menu the following will appear on the display:

VAL 40 r → valve enabled to be opened

Press **ENTER** to access the submenu.

Under the **VP** menu, the message **PSSD (password requested)** appears; press **ENTER** to enter the four digits of the password to be entered (the operator must have the password).

Use the up and down buttons to select the digit to be set, once the desired digit is displayed, press **ENTER** to confirm it. Repeat the same operation for all four digits.

After selecting the last digit and having pressed **ENTER**, press again **ENTER** to start the opening of the valve.

At the end of the of the occurred opening the display shows the message "**SUCCESS**".

Under the **SV** menu, the display will show:

VAL 00 A → open valve

4.2. Digital outputs

RSE does not have any digital outputs

4.3. Data recording

With reference to the standards of the series UNI/TS 11291, RSE implements in particular the following services:

UNI/TS 11291-1 4.3.3 Service: Dynamic multi-rate capacity
UNI/TS 11291-1 4.3.7 Service: Metering and load profiles
UNI/TS 11291-6 5 Detection and recording of data

4.4. Acquisition

The flow rate measurement is carried out continuously by means of the mechanical system consisting of two measuring chambers (of known volume) with deformable diaphragms, which expand and contract alternately. This movement, induced by the pressure difference between the inlet and outlet passages, operated by a crank mechanism, is transmitted to a pin that makes a complete turn every cyclic volume of gas passing through.

The movement of the pin causes the rotation of an encoder; such rotation is detected by means of two optical sensors. The management of both HW and SW is carefully optimized to minimize the consumption of the measuring circuit and the processor awakening time.

The optical sensor provides sufficient resolution to allow the measurement of the amount of gas, both during operation and for the certification/production/calibration steps, using in this case a modified counting algorithm.

The two pairs of LED phototransistor sensors are positioned at 90° to one another. For each rotation of the encoder divided into full and empty sectors, a given sequence of statuses is therefore available.

The coding of this sequence allows identifying a regular counting, a reverse rotation, or an oscillation. In this way, it is possible not to affect the taken measurement in any way.

The system, consisting of an encoder and optical sensors, represents the interface between the measuring mechanics and the calculation and management electronics.

The piloting and detection of the optical sensors is entrusted directly to the microprocessor, which performs also an ongoing diagnostic activity to highlight any faults and fraud attempts made by blinding the sensors. The piloting of the sensors is carried out in a controlled manner, which is such as to assure proper operation during the whole RSE life-cycle.

The measurement of the temperature, required for the calculation of the volumes on the reference thermodynamic conditions, is carried out using a temperature sensor with a resolution of 10 bits, which provides a measurement in Kelvin degrees with a resolution of 0.25°C in a time span of 50ms.

The measurement of the gas temperature is acquired and updated every 30 s.

4.5. Events and diagnostics

With reference to the standards of the series UNI/TS 11291, RSE implements in particular the following services:

UNI/TS 11291-1	4.3.9	Service: Detection and reporting of anomalies
UNI/TS 11291-6	7.1	Functional Requirements - Event Log
UNI/TS 11291-6	7.6	Functional Requirements - Diagnostics and alarms

4.6. Activation

With reference to the standards of the series UNI/TS 11291, RSE implements in particular the following services:

UNI/TS 11291-1	4.3.1	Service: Synchronization
UNI/TS 11291-1	4.3.6	Service: Software updating
UNI/TS 11291-1	4.3.8	Service: Management and Maintenance of the infrastructure
UNI/TS 11291-6	7.3	Functional Requirements - Programming
UNI/TS 11291-6	7.4	Functional Requirements - Operations concerning commissioning and maintenance
UNI/TS 11291-6	7.5	Functional Requirements - Clock

4.7. Communication

RSE has two communication interfaces, a local one and a remote one:

Local interface:

Optical port Infrared port complying with the standard EN 62056-21; it requires an external device (ZVEI probe);

The protocol used for the ZVEI optical port is DLMS.

The asynchronous format and the speed of the optical port are set to the following values:

Velocity: 9600 baud, format: 1(start bit), 8 (data bit), N (no parity), 1 (stop bit)

The ZVEI optical port is normally off. To enable it, follow the instructions given in chapter 7.1.19.1

Remote interface:

GSM modem Integrated in the device, antenna included and not remotizable;

The GSM modem, including the antenna, is integrated in the meter.

4.8. User interface

The user interface consists of a LCD display and three operator keys. The interface allows only the consultation of the parameters and provides access to the **SD** "status of the device" menu.

5. Installation

RSE is suitable for installation in hazardous areas classified as ATEX Zone 2.

RSE meets the protection requirements of type: II 3G Ex ic IIB T3 Gc.

3G: For use in Zone 2 atmospheres; therefore, it is safe in case of operation without interferences.

IIB: It establishes the maximum ignition energy that shall not be exceeded and, therefore, with what types of gas the product can be used in a safe manner (e.g.: ethylene).

T3: It defines the maximum allowable surface temperature equal to 200 °C.

Caution!

Before beginning with the installation, read and verify the safety instructions contained in the first chapter carefully

5.1. Mechanics installation

The overall dimensions of RSE are shown below.

RSE is fastened to the system using a special shelf for GAS meter.

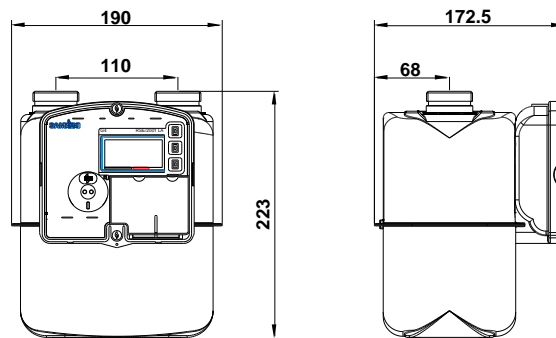

Model RSE/2001 LA

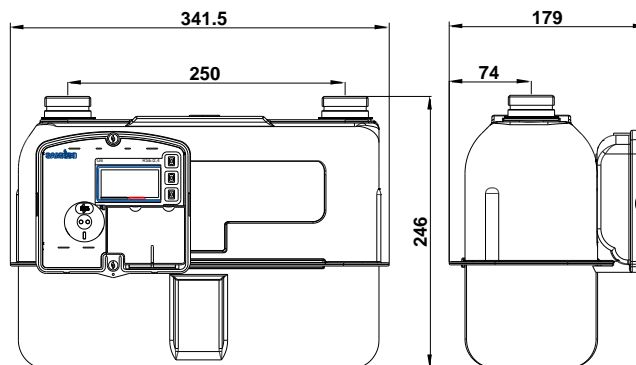

Model RSE/2,4

Fig. 5 – Overall dimensions

5.2. Connection to the system

- After installation, RSE must be connected to the system. Before connection, make sure that at least the portion of the plant upstream of the meter is sectioned and that, therefore, there cannot be any flow of gas during the installation;
- Before connection, make sure that the maximum system pressure is lower than the maximum pressure set for the meter, which is fixed and equal to 0.5 relative bar;
- If necessary, use fittings (not supplied) to connect RSE to the piping.
- During the tightening of the fittings, do not exceed the torque of 110Nm;
- RSE operates only in vertical position;
- RSE is provided with an on/off valve in the "open" status; therefore, it is ready to deliver and measure.
- Verify that the utilities on the customer side are closed.
- Slowly load the RSE meter with pressure.
- If on the meter a piping for pressure measurement has been subsequently installed, check the tightness of the related connection.
- After leak testing, slowly remove pressure to the RSE meter.

Once the tightness has been checked, the meter is ready for use.
The meters of the company SAMGAS require no maintenance.

WARNING

When the meter is disassembled, it may contain a residual amount of gas. Considering the danger of explosion, it is necessary to take safety measures, e.g.:

- After disassembling the RSE meter, clean it very well with an inert gas.
- For transporting the meter with residual amounts of gas, use a vehicle with an open or vented loading area.

5.2.1.Using the ZVEI probe

The ZVEI probe (available as an option) is equipped with magnetic coupling. Place the probe in the provided groove on the front part of RSE with the cable facing downwards. The magnet and the groove will retain the probe in place.
To enable the communication on the ZVEI optical port, it is sufficient to let the display show the SD menu.

	RSE METER Use and Maintenance Manual Point to point Version	ENGLISH	
		ISV066UTE	Rev.10

5.3. Power supply

The RSE meter can be powered exclusively by batteries.

The metrological battery is dimensioned to assure the operation of RSE for at least 15 years. The battery autonomy was estimated in the following reference operating conditions:

The GSM transmission battery is dimensioned to assure the operation of RSE for at least 8 years. The battery autonomy was estimated in the following reference operating conditions:

GSM communication to the Distributor:

1 GSM cycle per day (20 s recording, 30 s continuous data transmission)

2 code update in 15 years

Display message/ZVEI communication

5 minutes per month

Valve control:

1 complete control (including 1 opening and 1 closing) every year

1 valve test period (valve periodic test) 1 cycle per month

Ambient temperature profile:

5% of the time at -25°C;

20% of the time at -10°C;

50% of the time at 22°C;

20% of the time at 55°C;

5% of the time at 70°C.

RSE implements and manages service quality logs, available only through the communication channels (not on the display) able to verify the deviation of the actual operating conditions from the reference ones.

5.3.1. Connecting the batteries

RSE is supplied with the metrological battery already connected and inserted in the related compartment; therefore, RSE is ready for operation.

5.3.2. Supply status

Power status shows the current battery level.

The functionality of calculation of the actual use of the battery has been implemented in order to signal when the limit of 90% is reached. A weight has been configured for the main activities of the device (periodic and not). Therefore the actual consumption of the battery is calculated according to the time elapsed, the individual functions actually performed and the weight in terms of consumption. When this estimate exceeds 90% of the value set as threshold, the appropriate alarm event is generated.

Date of issue 04/06/2014	Revision 10	Revision date 03/02/2016	Page 14 of 33
---	------------------------------	---	----------------------

5.4. Security and fraud prevention

The solutions implemented on the RSE meter to assure the security comply with the requirement set forth by the standard UNI TS 11291.

With reference to the standards of the series UNI/TS 11291, RSE implements in particular the following services:

UNI/TS 11291-1 4.3.2 Service: Detection and reporting of fraud

UNI/TS 11291-1 4.3.10 Service: Security Management

UNI/TS 11291-6 7.2 Functional Requirements - Access

RSE implements all security policies defined by the reference standards and, in particular, by UNI TS 11291. In detail:

- Access to the electronics is not possible without removing the mechanical and metrological seal and without permanently damaging the metrological cover;
- Access to the memory device is not possible without permanently and patently damaging the meter;
- Access to the flow on/off valve and the temperature sensor is not possible without permanently and patently damaging the meter;
- Access to the metrological battery and to the non-replaceable transmission battery is not possible without removing the mechanical and metrological seal and without permanently damaging the metrological cover;
- Access to the replaceable communication battery is not possible without leaving a record of the event in the Metrological Log of the meter;
- Using interface equipment usually available to the user it is only possible to read the data and it is not possible to perform any configuration;
- The configurations that can be performed through the communication channels with which the device is equipped - which can be carried out only by authorized personnel - leave a track as they are stored in the relevant memory log (Metrological Log);
- Attempts to tamper with the proper functioning of the meter are detected and recorded in the Metrological Log;
- Attempts to access the meter through the communication channels with which it is equipped by unauthorized personnel are detected and recorded in the Metrological Log;
- The commands sent by external devices through the communication channels with which the device is equipped are verified in terms of the source authenticity;
- The messages transmitted through the communication channels conveying sensitive information are all efficiently encrypted;
- Attempts to access the meter through the communication channels made with wrong passwords or encryption keys are detected, listed and made available to the control center;
- The duration of the conditions is monitored and recorded.

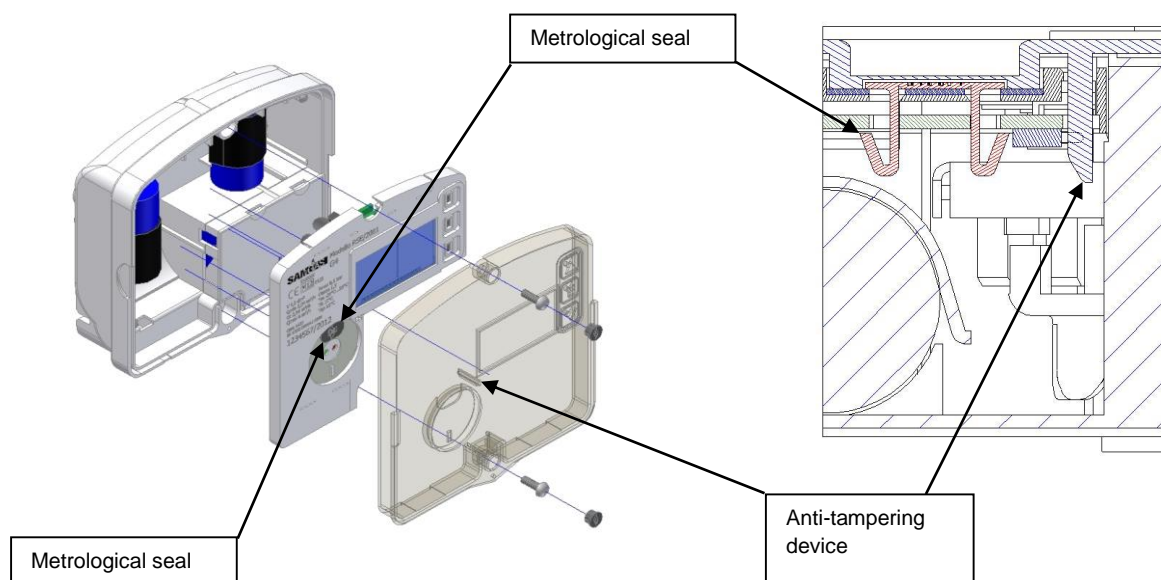

6. User interface

The user interface consists of three operator keys and a display. The following paragraphs describe the interaction between the operator and the user interface, and the meanings of the various fields available on the display.

With reference to the standards of the series UNI/TS 11291, RSE implements in particular the following services:
UNI/TS 11291-1 4.3.5 Service: Consumer information
UNI/TS 11291-6 8.2 Construction requirements - Display

6.1. Keyboard

The interaction occurs through three keys: up and down scrolling (blue color) and Enter (green) on the front of the device.

6.2. Display

The display is a black and white LCD display consisting of 8 7-segment characters and a series of icons and symbols whose meaning is described below.

The size of the digits represented by the 8 7-segment characters are compatible with the requirements of MID and EN12405-1.

The construction technology of the LCD element (display) is such as to assure a lifetime of over 15 years under operating conditions which include also prolonged exposure to sunlight.

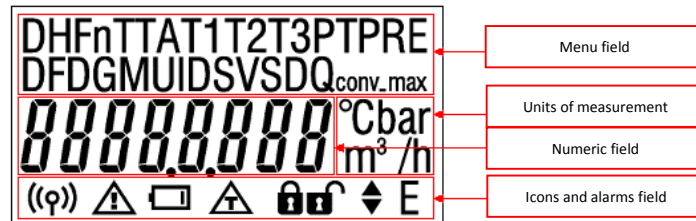

The meaning of the graphical elements is outlined in the following table:

Menu field	Each menu can be identified by a letter or a combination of letters and numbers
Units of measurement field	See table for units of measurement
Numeric field	8 7-segment digits displaying the value associated with the displayed menu
Icons and alarms field	See table for icons and alarms

To allow a long battery life, the display is usually kept OFF. To activate it, just press the green central key.

6.2.1. Display testing capabilities

When the display is turned off and the green central key is pressed, a test sequence is displayed to check the presence of defective segments or icons.

The test sequence lasts 3 seconds and turns on all segments and icons of the display at the same time. At the end of this step, the first page of the menu is displayed.

6.2.2. Menu field

Icon	Meaning	Notes
T	Totalizer of volumes under reference conditions	
TA	Totalizer of volumes subject to alarm	
T1	Totalizer of volumes under reference conditions for range 1	
T2	Totalizer of volumes under reference conditions for range 2	
T3	Totalizer of volumes under reference conditions for range 3	
PRE	Added to T, TA, T1, T2 or T3	When the count refers to previous billing periods
DF	Invoice date	
DG	Diagnostics	
MU	Message to the user	When the count refers to previous billing periods
ID	ID of the re-delivery point	
SV	Status of the valve	
SD	Status of the device	
Q _{conv.max}	Maximum conventional flow rate	
D	Date	
H	Hour	
Fn	Current price range	









6.2.3. Units of measurement field

Icon	Meaning	Notes
°C	When a temperature value is displayed	
bar	When a pressure value is displayed	
m ³	When a volume value is displayed	
/h	When a flow rate value is displayed	Used together with the icon m³

6.2.4. Numeric field

It consists of 8 7-segment digits and gives the value associated with the displayed menu page.

6.2.5. Icons and alarms field

Icon	Description	ON	Flashing
	Communication	Radio communication active	
	General warning	Active alarm	Alarm not active but previously recorded and not yet displayed
	Low battery	Low battery to be replaced (residual charge <10%)	
	Temperature alarm	Active alarm	Alarm not active but previously recorded and not yet displayed
	Authentication required	Authentication required to access the submenu functions	
	Authentication performed	Authentication occurred. It is possible to access the submenus	
	Available scrolling keys	Available scrolling keys to navigate the submenus	
	Enter key available	Enter key available	

7. Menu structure

This section shows the hierarchy of the pages making up the interface with the user.

Under normal operating conditions, the display is completely off. Pressing the green Enter key, the display turns on and performs a test in which all segments and icons are lit simultaneously for three seconds. At the end of the test, the first page of the menu is displayed.

If not any key is pressed for about two minutes, the display returns to off status.

By pressing the up and down keys, it is possible to navigate through the various menus. Pressing the up button, it is possible to go back to the previous page; pressing the down button, it is possible to move to next page.

Some menus consist of various submenus; in this case, the letter E (Enter) is displayed on the lower right corner of the display. By pressing the green Enter button, the submenu appears. By pressing the up and down buttons, it is possible to navigate inside the submenus.

7.1. Chapters

The various menus are identified by the letters shown on the display under "menu field".

Here below, there are the menus displayed in sequence, scrolling down after switching on the display.

The sequence is circular; the list can be scrolled indifferently downwards and upwards. Once the corresponding end is reached, the display continues in the order defined below.

7.1.1. Totalizer of volumes under reference conditions in the current billing period

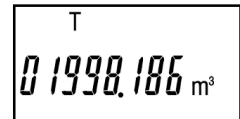

Abbreviation	T
Format	5 integers and 3 decimals
Unit	m ³
Pressing enter	-
Legal relevance	YES

7.1.2. Totalizer of volumes subject to alarm in the current billing period

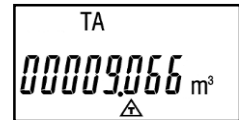

Abbreviation	TA
Format	5 integers and 3 decimals
Unit	m ³
Pressing enter	-
Legal relevance	YES

7.1.3. Totalizer of volumes for price range 1 in the current billing period

T1
 01802834 m³

Abbreviation T1
Format 5 integers and 3 decimals
Unit m³
Pressing enter -
Legal relevance YES

7.1.4. Totalizer of volumes for price range 2 in the current billing period

T2
 00030805 m³

Abbreviation T2
Format 5 integers and 3 decimals
Unit m³
Pressing enter -
Legal relevance YES

7.1.5. Totalizer of volumes for price range 3 in the current billing period

T3
 00079590 m³

Abbreviation T3
Format 5 integers and 3 decimals
Unit m³
Pressing enter -
Legal relevance YES

7.1.6. Totalizer of volumes under reference conditions in the previous billing period

T PRE
 00000598 m³

Abbreviation T PRE
Format 5 integers and 3 decimals
Unit m³
Pressing enter -
Legal relevance YES

7.1.7. Totalizer of volumes subject to alarm in the previous billing period

TA PRE
 00000000 m³

Abbreviation TA PRE
Format 5 integers and 3 decimals
Unit m³
Pressing enter -
Legal relevance YES

7.1.8. Totalizer of volumes for price range 1 in the previous billing period

T1	PRE
	

Abbreviation T1 PRE
Format 5 integers and 3 decimals
Unit m³
Pressing enter -
Legal relevance YES

7.1.9. Totalizer of volumes for price range 2 in the previous billing period

T2	PRE
	

Abbreviation T2 PRE
Format 5 integers and 3 decimals
Unit m³
Pressing enter -
Legal relevance YES

7.1.10. Totalizer of volumes for price range 3 in the previous billing period

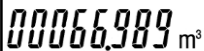
T3	PRE
	

Abbreviation T3 PRE
Format 5 integers and 3 decimals
Unit m³
Pressing enter -
Legal relevance YES

7.1.11. Invoice date

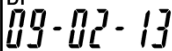
DF

Abbreviation DF
Format dd-mm-yy
Unit -
Pressing enter -
Legal relevance YES

It expresses the date on which the data of the previous period do refer (T/TA/T1/T2/T3 PRE)

7.1.12. Diagnostics



Abbreviation DG
Format 4 digits (hexadecimal code)
Unit -
Pressing enter -
Legal relevance YES

The encoding of the information shown complies with the provisions of the standard UNIT11291-11-, chapter 5.4.9.2, given here below.

Bit	Meaning
15	Reserved
14	Reserved
13	Reserved
12	1 = Valve enabling anomaly
11	1 = Daylight Saving Time active
10	1 = Tampering detected
9	1 = Battery level critical
8	1 = Battery level lower than 10%
7	1 = Device not configured or under maintenance; 0 = device configured
6	1 = Memory error
5	1 = Flow rate error
4	1 = Device generic error
3	1 = Measurement algorithm error
2	1 = Metrological Event Log \geq 90%
1	1 = Metrological Event Log complete
0	1 = Clock synchronization failed

The 16 bits mentioned above are represented using a hexadecimal encoding (0 – F) by sets of 4, as shown below:

BIT	15	14	13	12	11	10	9	8	7	6	5	4	3	2	1	0
DIGIT	4				3				2				1			

Example:
 Diagnostics:
 Hexadecimal encoding: 0 8 0 2
 Binary encoding: 0000 1000 0000 0010
 Meaning:
 Bit 1 = 1 → Metrological Event Log complete
 Bit 11 = 1 → Daylighth saving time (ora legale) attiva

7.1.13. User Message



Abbreviation MU
Format Text - 100 characters
Unit -
Pressing enter -
Legal relevance NO

User message; information displayed pursuant to the provisions of the standard UNITS11291-11-1, chapter 5.4.8.13.

7.1.14. Redelivery Point (PDR) ID



Abbreviation ID
Format 14 digits
Unit -
Pressing enter E
 By pressing enter, it is possible to scroll the 14 digits in both directions using the arrow keys.

Legal relevance Yes

Redelivery Point (PDR) ID

7.1.15. Status of the valve

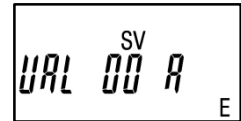

Abbreviation SV
Pressing enter Press the central button to access the valve menu
 The menu structure is shown below:
 To enter the password using the up and down buttons to select the numbers; then, press the enter button to confirm.
 To perform the leak testing, press the Enter button.
 Here below, there are all the submenus:

menu id	Operation	Description
VAL	00 A	Open valve
	00 C	Closed valve
	00 r	Valve enabled to be opened
VR	Nn	VR remaining time
VT	Nn	VT number of attempts
VP	PSSD	VP password entering Up and down to select Enter to confirm
VL	nn	VL leak testing and result (dm3)

Legal relevance NO

7.1.16. Status of the device



Abbreviation
Format

SD
1 digit – Possible values:

- -2 production
- -1 factory
- 0 device configured
- 1 device under maintenance
- 3 device not configured

Unit
Pressing enter

-
E
Pressing the central button, access is granted to the maintenance menu.
The menu structure is shown below
2 decimal digits define the menu id
2 decimal digits define the operation id
2 decimal digits define the operation result
To perform the maintenance test, if allowed, it is necessary to press the central button.
Here below there is a list of submenus:

menu id	operation	result	Description
01	01	00-01	ZVEI port status 00 = disabled 01 = enabled
01	02	00-01-02	Enabling the ZVEI port. 00 = operation not yet preformed 01 = operation performed successfully 02 = operation failed
01	03	00-01-02	Disabling the ZVEI port. 00 = operation not yet preformed 01 = operation performed successfully 02 = operation failed
02	01	00-01	Counting resolution status 00 = Normal resolution 01 = Resolution subject to testing
02	02	00-01-02	Setting of the counting resolution 00 = operation not yet preformed 01 = operation performed successfully 02 = operation failed
02	03	00-01-02	Setting of the normal resolution 00 = operation not yet preformed 01 = operation performed successfully 02 = operation failed
03	-	-	Display of the read temperature
04	-	00-07	Setting of the display contrast. Press enter, and then the up/down keys to select the desired contrast value for the LCD display; then, press enter to confirm.
05	01	-	Reserved – factory diagnostic
05	02	-	Reserved – factory diagnostic
06	01	00-01-03-88	Remote Communication Status 00 = stand-by 01 = call in progress 03 = communication occurred successfully 88 = failed communication
06	02	00-01	Start Remote communication 00 = press "Enter" to enter password 01 = Password recognized – communication start The password coincides with the valve enabling value and it can be changed using the same command...
06	03	00-01-02-... -30-31-99	Last communication RSSI value 00 = -113 dBm or less (or no connection made) 01 = -111 dBm 02..30 = from -109 to -53 dBm with 2 dBm steps 31 = -51 dBm or greater 99 = not known or not detectable or currently not available
99	-	-	Exit Press enter to close the maintenance menu and return to the main menu.

Legal relevance

NO

7.1.16.1. Enabling and disabling of the ZVEI port

- From the main SD menu, press the central button to access the submenu

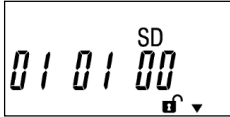

ZVEI port status: Disabled

- Press the lower button once

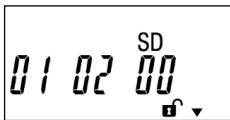

Submenu to enable the ZVEI port

- Press the central button

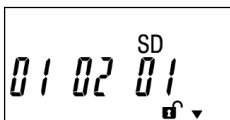

The operation was completed successfully

- Press the upper button once

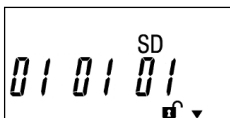

ZVEI port status: Enabled

- Press the lower button twice

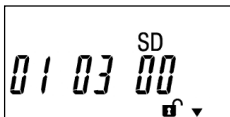

Submenu to disable the ZVEI port

- Press the central button



The operation was completed successfully

- Press the upper button twice

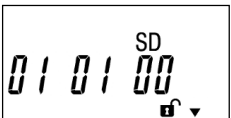

ZVEI port status disabled

7.1.16.2. Enabling and disabling of the counting for the test phase

- From the main SD menu, press the central button to access the submenu
- Press the lower button three times

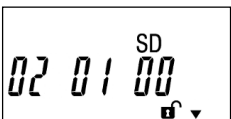

The meter is counting with normal resolution

- Press the lower button

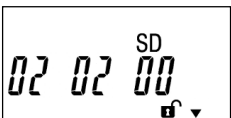

Menu to set the counting in high resolution

- Press the central button

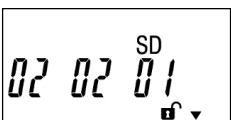

The operation was completed successfully

- Press the upper button

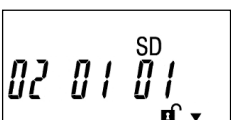

The meter is counting with high resolution

6. Press the lower button twice

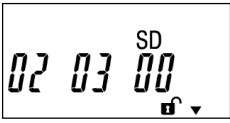

Menu to set the counting in low resolution

7. Press the central button

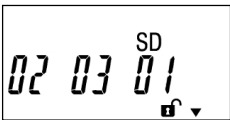

The operation was completed successfully

8. Press the upper button twice

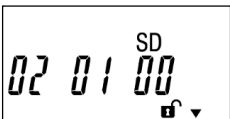

The meter is counting with normal resolution

7.1.17. Maximum conventional flow rate

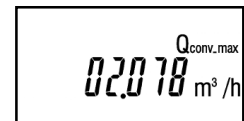

Abbreviation	Qconv_max
Format	2 integers and 3 decimals
Unit	m ³ /h
Pressing enter	-
Legal relevance	YES

7.1.18. Date

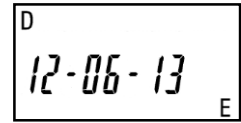

Abbreviation D
Format dd-mm-yy
Unit -
Pressing enter E

By pressing enter, it is possible to display the version CRC of the certificate modules and other information on the software.

The submenus are listed below:

- CRC16 Legally Relevant SW
- Legally Relevant SW internal release
- CRC16 Not Legally Relevant SW
- Not Legally Relevant SW internal release
- Release date
- Release time
- CRC16 Boot module
- CRC16 Header module
- CRC16 Loader module
- CRC16 Hal module
- CRC16 Kernel module
- CRC16 Stm32lib module
- CRC16 KSystem module
- CRC16 Security module
- CRC16 Display module
- CRC16 Metric module
- CRC16 Plugin header
- CRC16 Plugin module
- System global uptime (days) including low power and running mode
- System global uptime (h-m-s) including low power and running mode
- System running mode uptime (days)
- System running mode uptime (h-m-s)
- Total number of events
- Code started events
- Consid. param modified events
- Security param modified events
- New SW run events
- Upgrade errors
- Total CRC errors (Kernel + Data)
- Kernel only CRC errors
- Attempted fraud events

Legal relevance YES

7.1.19. Time

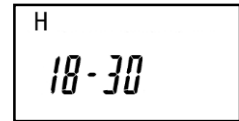

Abbreviation H
Format hh-mm
Unit -
Pressing enter E
 By pressing enter, it is possible to view the log of the last 32 firmware updates.
 For each firmware updates a block of three submenus is added:

- CRC16 LR of the firmware
- Updating date
- Updating time

 The firmware loaded at the factory is the oldest entry (date and time set to 00-00-00).
 If the download fails, four dashes ("----") are displayed instead of CRC 16 LR.

Legal relevance YES

7.1.20. Current rate

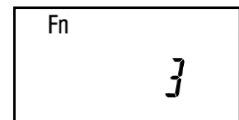

Abbreviation Fn
Format 1 digit
 Possible values:

- 1 Range 1
- 2 Range 2
- 3 Range 3

Unit -
Pressing enter -
Legal relevance YES

8. Configuration

The device configuration can occur from the local ZVEI port or remotely from SAC, always by means of the DLMS protocol, as specified in the provisions of the standards series UNI/TS 11291.

9. Maintenance

9.1. Ordinary maintenance

9.1.1.Replacing the batteries

The RSE metrological battery is sized to assure an autonomy of more than 15 years under normal environmental and operating conditions (see paragraph 10.3) and, therefore, it is not necessary to replace it.

The GSM transmission battery is sized to assure an autonomy of more than 8 years under normal environmental and operating conditions (see paragraph 10.3) and it is possible to replace it.

To replace it, just remove the seals on the front cover; unscrew the two tightening screws; remove the front transparent cover; open the battery cover and disconnect the battery connector from the card.

Repeat the same steps in reverse order to connect the new battery (Fig.6).

When the transparent front cover is removed, a mechanic anti-tampering device will generate a signal of occurred removal of the front cover.

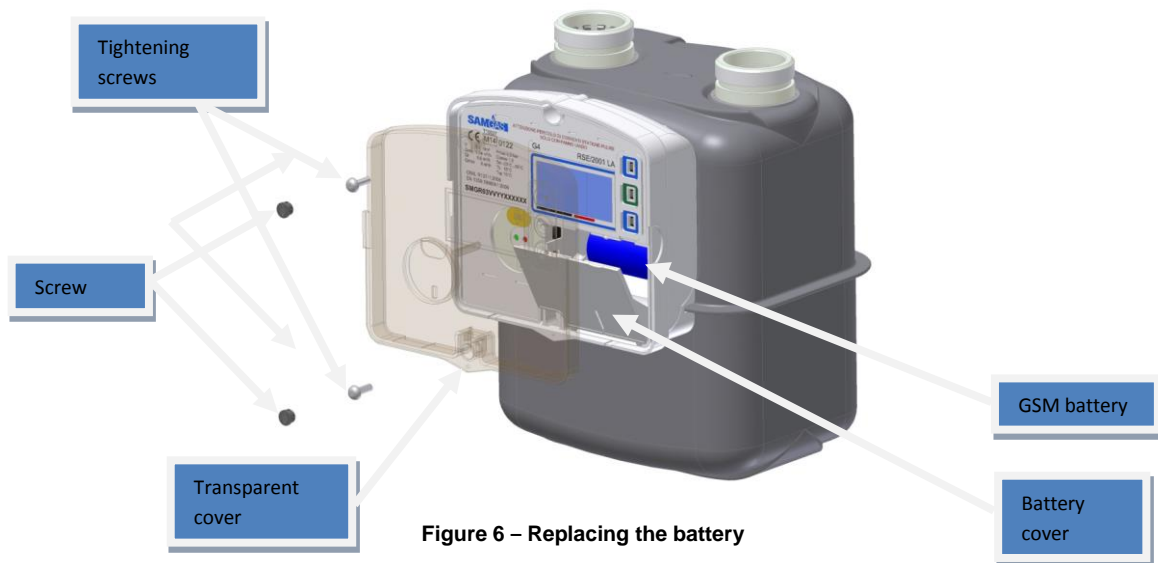
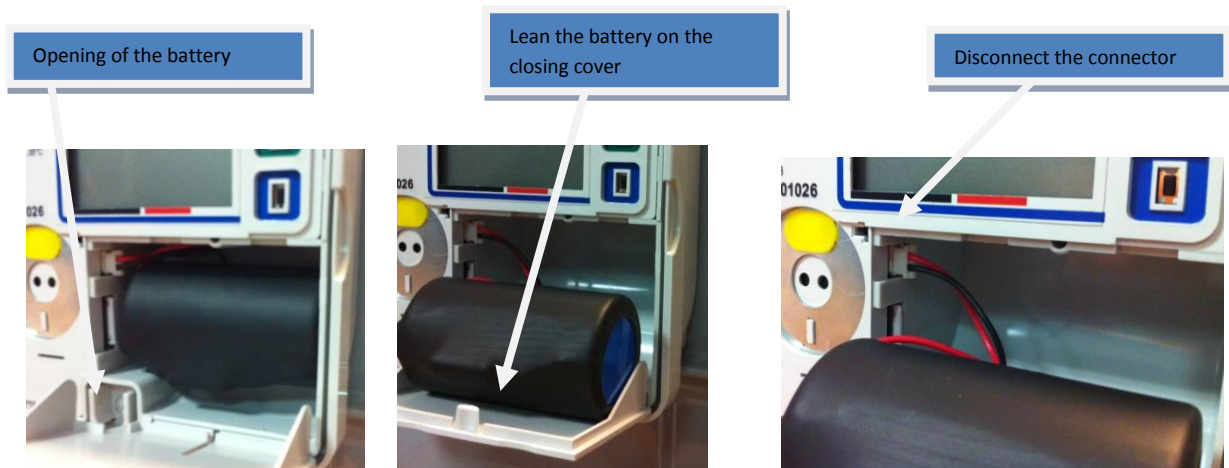

Figure 6 – Replacing the battery



9.1.2. SIM Replacement

To replace the SIM, proceed as follows:

- Remove the seals from the front cover (fig.6);
- Unscrew the two tightening screws (fig.6).
- Remove the transparent front cover (fig.6);
- Open the battery cover;
- Shift the battery;
- Press the SIM card to activate the push/pull extraction mechanism;
- Remove the SIM;
- To reinsert the SIM follow these same steps in opposite sequence paying attention to the proper insertion direction in the relevant seat.

When the transparent front cover is removed, a mechanic anti-tampering device will generate a signal of occurred removal of the front cover.

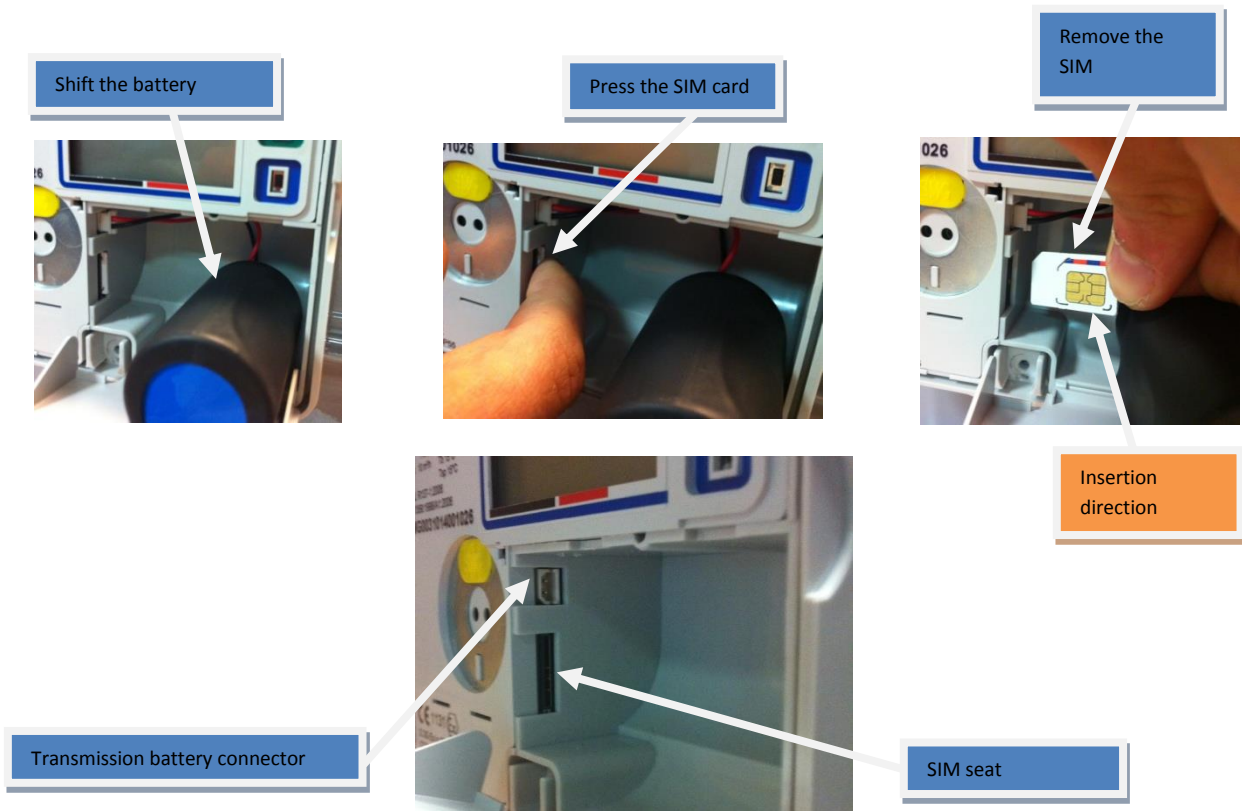

9.1.3. Firmware update

In case of release of a new firmware version, the notes that describe the changes made since the previous version are distributed. The firmware update can easily be performed also remotely. Contact Samgas for further details

9.2. Device replacement and disposal

Upon removal, if necessary, the device has to be disposed of according to the regulations on the management of waste in force at the time of disposal. (On the current date, the Italian Legislative Decree No. 152/2006, as amended and integrated, is in force in Italy).

10. Technical characteristics

10.1. General features

Parameter	Features	
Enclosure	Main body:	Polycarbonate
	Transparent cover:	Polycarbonate
Protection degree	IP 55	
Dimensions (overall)	RSE/2001 LA	Max 223(H) x 190(L) x 172,5(P)
	RSE/2.4	Max 246(H) x 341.5(L) x 179(P)
Distance	RSE/2001 LA	110 mm
	RSE/2.4	250 mm
Type of gas	Methane gas, town gas, propane and butane gas from the first to the third family	UNI EN 437:2003
Operating pressure	0.5 bar	
Display	Black and white LCD with segments	
Resistance to high temperatures "T"	Resistance to high temperatures	EN 1359:1998+A1:2006, paragraph 6.5.5
Keyboard	3-front operator keys	
Operating/storage temperature	-25°C to +55°C / -25°C to +60°C	
Certifications	Atex (Ex ic 3G IIB T3 Gc), MID	
Metrological battery	Type:	3.6 V lithium battery
	Format:	Size C
	Autonomy:	>15 years
Transmission battery	Type:	3.6 V lithium battery
	Format:	Size D
	Autonomy:	>8 years
Microprocessor	STM32L152	32 bit
Code memory	384 Kbyte of Flash type	
Data memory	Type:	EEPROM 12 Kbyte
	Data memory	>20 years
Real Time Clock	RTC always active Accuracy according to EN62054-21	
Accuracy	Accuracy class 1.5/1	According to MID

(*) Operating conditions

Ambient temperature	Ta min (-25°C)
Range	Max
Use of user interface	5 minutes per month
Valve control	1 cycle per year
Code update	2 every 15 years

10.2. Communication ports

Parameter	Features	
Local communication port	Physical level	ZVEI (IEC 62056-21)
	Velocity	9600 baud
	Application level	Protocol DLMS

10.3. Feeding devices

RSE can ONLY be fed by a separate approved battery pack.

Metrological battery

The feeding of the metrological equipment is guaranteed by a non-rechargeable lithium battery with a duration > 15 years under reference operating conditions (see table below).

A single, non-rechargeable, cell with Lithium – Thionyl chloride technology (Li-SOCl₂) is used

The main features are:

Size C with Bobbin technology;

Rated voltage equal to 3.6 Vdc.

Rated capacity of about 8.5 Ah.

The Bobbin technology assures a maximum current limited by significant intrinsic internal resistance; however, it still provides sufficient current for the device operation.

Wiring with polarized connector, to assure proper connection to the printed circuit board.

The cell is fastened inside the meter; it cannot be replaced and it is protected by metrological seals.

GSM battery

The GSM version has an additional replaceable battery, positioned in a compartment accessible without removing the metrological seals.

A single, non-rechargeable, cell with Lithium – Thionyl chloride technology (Li-SOCl₂) is used

The main features are:

Size D with spiral technology;

Rated voltage equal to 3.6 Vdc.

Rated capacity of about 14.0 Ah.

The spiral technology allows the battery to provide peak currents appropriate for the operation of the GSM module.

Wiring with polarized connector, to assure proper connection to the printed circuit board.

The cell is enclosed within the meter, accessed by a small panel that can be opened without removing the metrological seals, yet protected by a mechanical anti-tampering device.

Reference operating conditions		
Amb. temperature	5% of the time @ -25°C 20% " @ -10°C 50% " @ 22°C 20% " @ 55°C 5% " @ 70°C	
Communication:	1 Connection per day	Registration = 20 sec Data transmission = 30 sec
User interface	5 minutes per month	Display/buttons/ZVEI
Temperature measurement	1 measurement every 29 sec	
Range	Qmax	
Code update	2 times in 15 years	