

# Reflux 819

High - Medium Pressure Gas Regulator

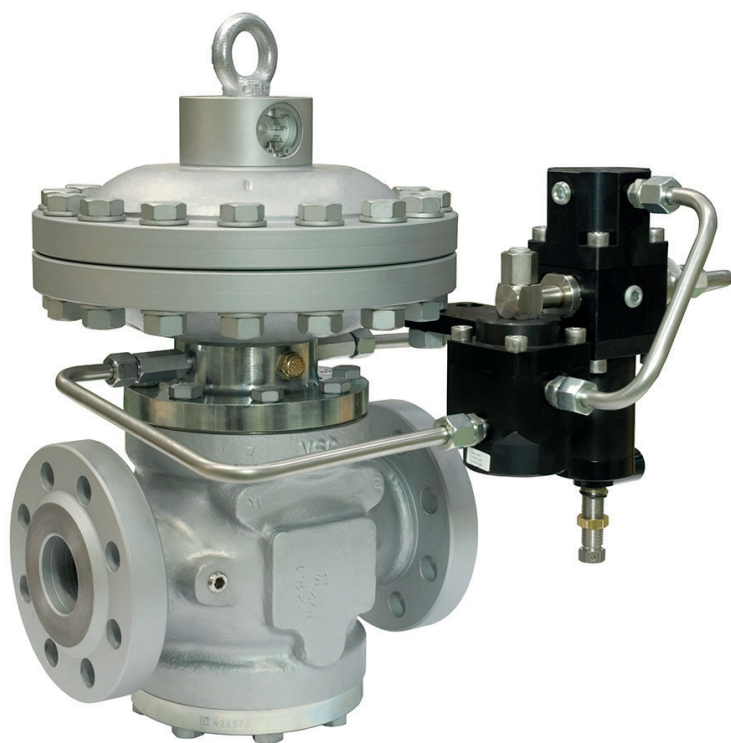

**TECHNICAL BROCHURE**

---

**Pietro Fiorentini USA Inc.**

606 Park Drive | Weirton, WV 26062, United States of America | +1 304 232 9115  
fio.westvirginia@fiorentini.com

**Pietro Fiorentini S.p.A.**

Via E.Fermi, 8/10 | 36057 Arcugnano, Italy | +39 0444 968 511  
sales@fiorentini.com

The data is not binding. We reserve the right  
to make changes without prior notice.

reflux819\_technicalbrochure\_USA\_revE

# Who we are

We are a global organization that specializes in designing and manufacturing technologically advanced solutions for natural gas treatment, transmission and distribution systems.

We are the ideal partner for operators in the Oil & Gas sector, with a business solutions that span the whole natural gas chain.

We are constantly evolving to meet our customers' highest expectations in terms of quality and reliability.

Our aim is to be a step ahead of the competition, with customized technologies and an after-sale service program undertaken with the highest level of professionalism.



## Pietro Fiorentini advantages



Localized technical support



Experience since 1940



Operating in over 100 countries



# Area of Application

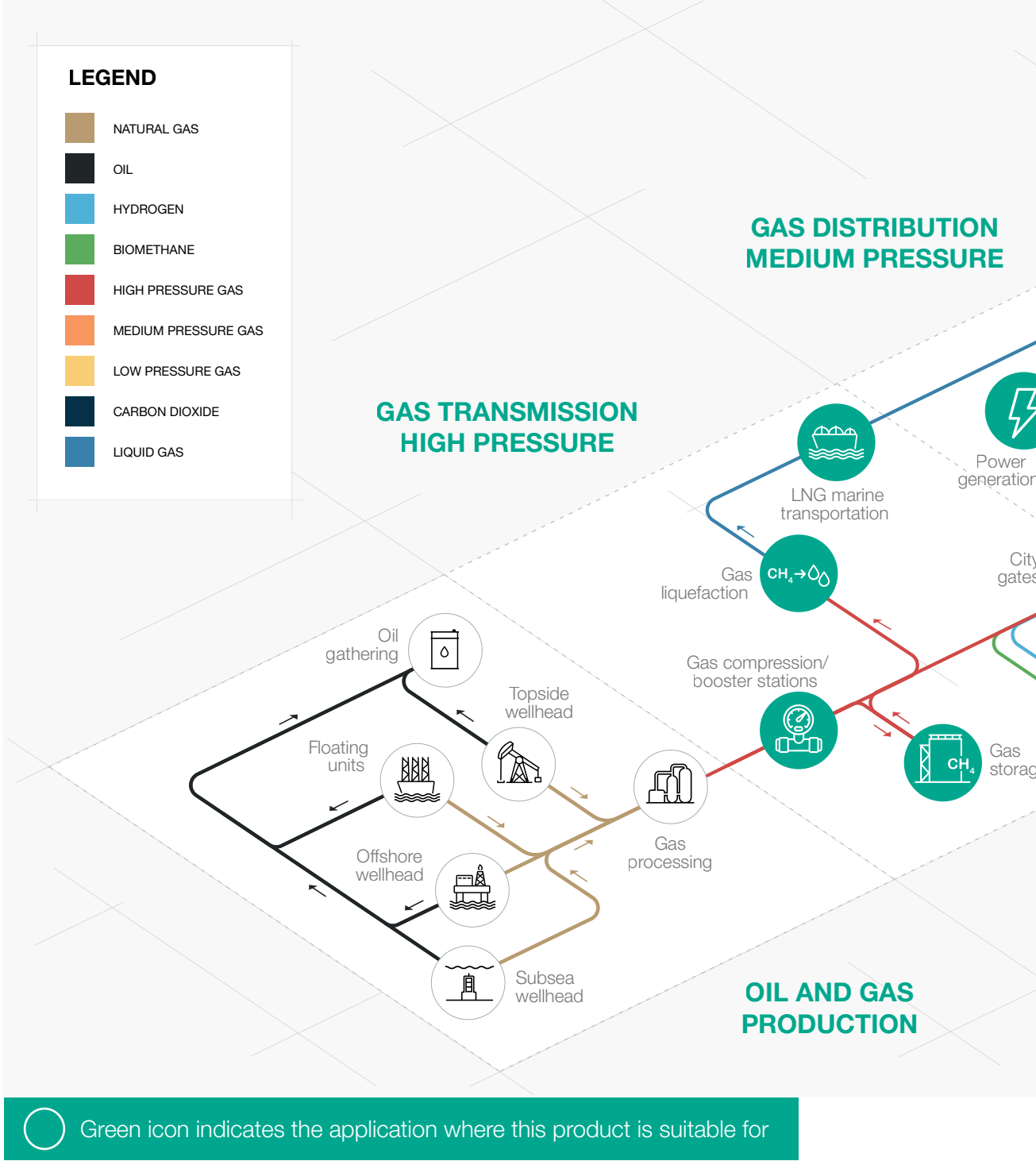

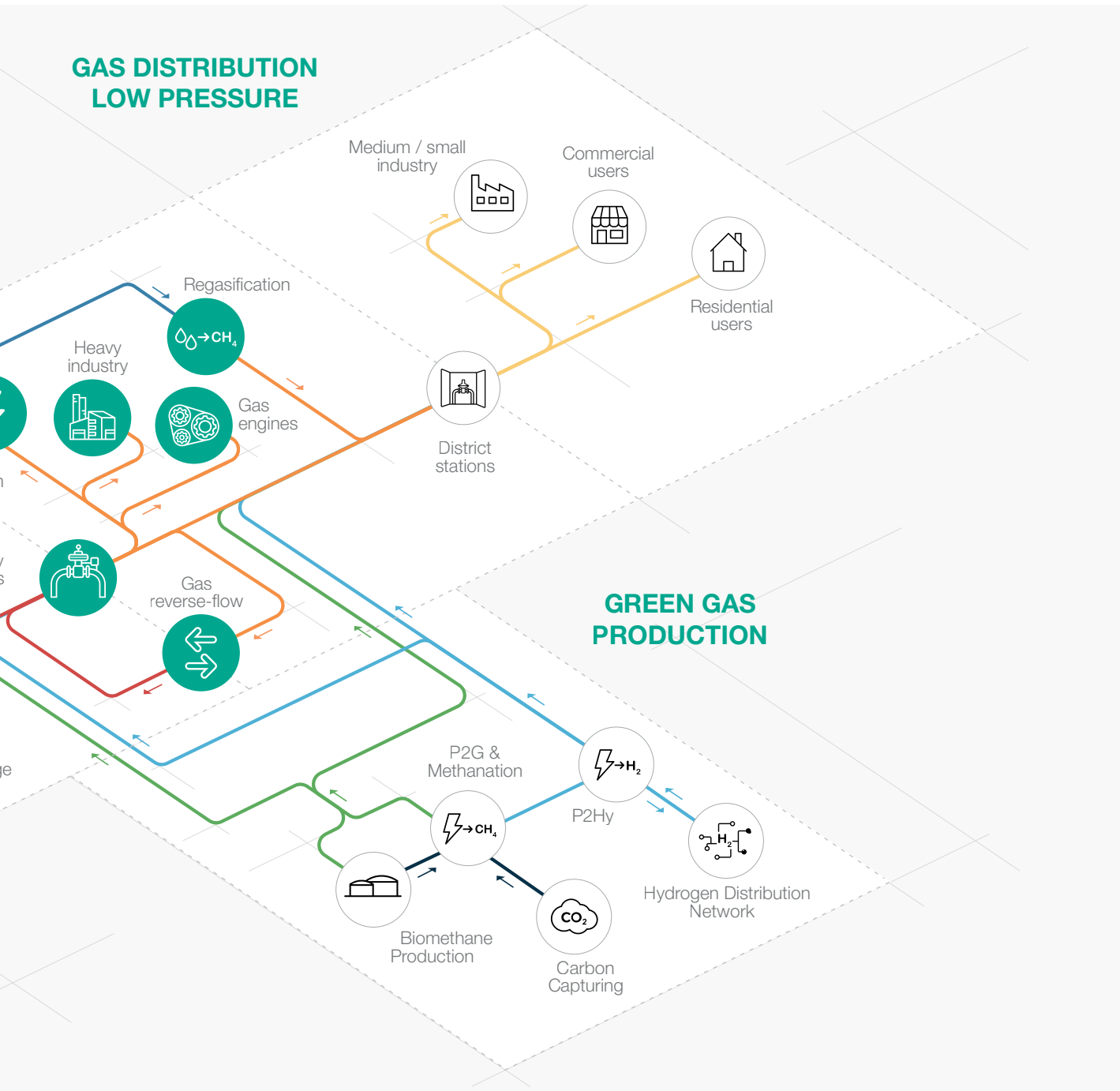

Figure 1 Area of application map

# Introduction

**Reflux 819** is one of the **pilot-operated gas pressure regulators** designed and manufactured by Pietro Fiorentini.

This device is suitable for use with previously filtered non-corrosive gases, and it is mainly used for high-pressure transmission systems, power plants and for medium pressure natural gas distribution networks.

According to the European Standard EN 334, it is classified as Fail Close (pilot series 200/A) or Fail Open (pilot series 210/A) according to the installed pilot (except for the PM819 monitor).

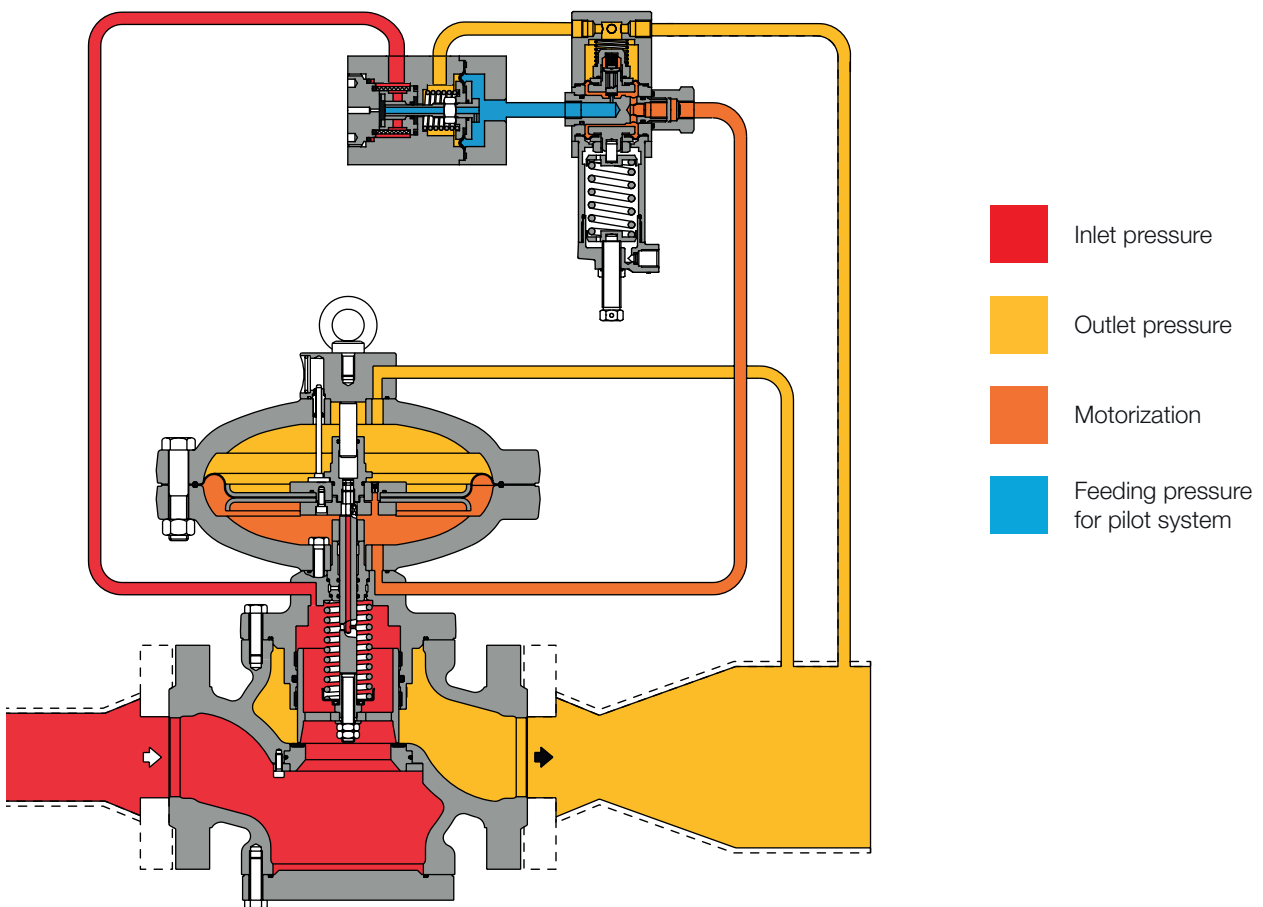

**Figure 2** Reflux 819

# Features and Calibration ranges

**Reflux 819** is a **pilot-operated** device for high pressure and medium pressure with an unique **dynamic balancing system** which ensures an **outstanding turn down ratio** combined with an extremely **accurate outlet pressure control**.

**Reflux 819** is a balanced pressure regulator. This means that the controlled outlet pressure is not affected by variations in the inlet pressure and flow during its operation. Therefore a balanced regulator can have a single-size orifice for all pressure and flow conditions.

This regulator is suitable for use with previously filtered, non corrosive gases, in natural gas transmission, power plants fuel gas skids and distribution networks as well as high load industrial applications.

It is a **truly top entry design** which allows an **easy maintenance** of parts directly in the field **without removing the body from the pipework**.

Set point adjustment of the regulator is achieved via a pilot, loading and unloading the pressure in the upper diaphragm chamber.

The modular design of Reflux 819 pressure regulators allows for the factory (or retro-site fitting) of an emergency monitor regulator PM/819 or a slamshut valve SB/82 or HB/97 (depending on size). Additionally an integral silencer DB819 can be installed. All without removing the body from the pipeline.

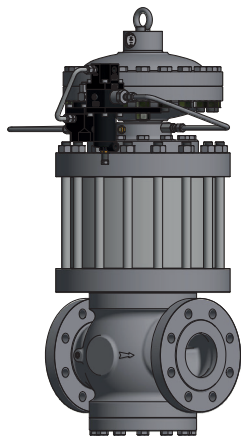



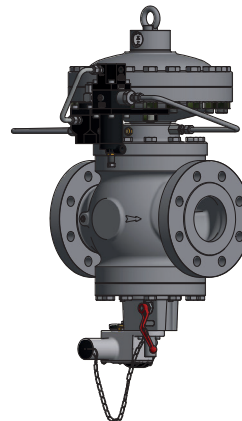







**Figure 3** Reflux 819 with silencer DB/819



**Figure 4** Reflux 819 with SB/82



## Reflux 819 competitive advantages

-  Compact and simple design
-  High accuracy
-  High turn-down ratio
-  Fail Close or Fail open plug and seat regulator
-  Built-in pilot filter
-  Top Entry
-  Easy maintenance
-  Built-in accessories
-  Biomethane compatible and available with specific versions for full Hydrogen or blending
-  Balanced type

## Features

Features	Values	
Design pressure* (PS <sup>1</sup> / DP <sup>2</sup> )	up to 10.2 MPa up to 1479 psig	
Ambient temperature* (TS <sup>1</sup> )**	<b>Standard version</b> from -20 °C to +65 °C from -4 °F to +150 °F	<b>Arctic version</b> from -40 °C to +65 °C from -40 °F to +150 °F
Inlet gas temperature* ,***	<b>Standard version</b> from -10 °C to +60 °C from +14 °F to +140 °F	<b>Arctic version</b> from -20 °C to +60 °C from -4 °F to +140 °F
Inlet pressure (MAOP / p <sub>umax</sub> <sup>1</sup> )	from 80 kPa to 10.0 MPa from 11.6 to 1450 psig	
Range of downstream pressure (Wd <sup>1</sup> )	from 30 kPa to 7.4 MPa from 4.35 to 1073 psig	
Available accessories	DB/819 silencer, LDB/171 silencer, PM/819 monitor, SB/82 slam shut, HB/97 slam shut	
Minimum operating differential pressure (Δp <sub>min</sub> <sup>1</sup> )	50 kPa   7.25 psig	
Accuracy class (AC <sup>1</sup> )	up to 1	
Lock-up pressure class (SG <sup>1</sup> )	up to 2.5	
Nominal size (DN <sup>1,2</sup> )	DN 25   1"; DN 50   2"; DN 80   3"; DN 100   4"; DN 150   6"; DN 200   8"; DN 250   10"; DN 300   12"	
Connections	Class 150, 300, 600 RF or RTJ according to ASME B16.5 and PN16 according to ISO 7005	
<p>(<sup>1</sup>) according to EN334 standard                      (<sup>2</sup>) according to ISO 23555-1 standard                      (*) NOTE: Different functional features and/or extended temperature ranges may be available on request. Stated inlet gas temperature range is the maximum for which the equipment's full performance, including accuracy is guaranteed. Product may have a different pressure or temperature ranges according to the version and/or installed accessories.                      (**) NOTE: Stated temperature range is the operating range for which the equipment's mechanical resistance and leakage rate are guaranteed. Some body materials, if multiple choices are available, may not be suitable for all the available versions shown.                      (***) NOTE: Stated temperature range is the range for which the equipment's full performance, including accuracy and lock-up are guaranteed. Some body materials, if multiple choices are available, may not be suitable for all the available versions shown.</p>		

**Table 1** Features



# Materials and Approvals

Part	Material
Body	ASTM A 352 LCC cast steel for classes ANSI 600 and 300; ASTM A 216 WCB cast steel for classes ANSI 150 and PN 16/40
Heads	ASTM A 350 LF2 steel
Stem	AISI 416 stainless steel
Plug	ASTM A 350 LF2 nickel-plated steel
Seat	Vulcanized Nitrile Rubber on metal support
Diaphragm	Rubberised canvas (pre-formed by hot-pressing process)
O-rings	Nitrile Rubber
Compression fittings	Made of zinc-plated steel according to DIN 2353; on request, stainless steel

**NOTE:** The materials indicated above refer to the standard models. Different materials can be provided according to specific needs.

**Table 2** Materials

## Construction Standards and Approvals

**Reflux 819** regulator is designed according to European standard EN 334.

The regulator reacts in closing (Fail Close) or opening (Fail Open) according to EN 334 depending on the pilot installed.

The product is certified according to European Directive 2014/68/EU (PED).

Leakage class: bubble tight, better than VIII according to ANSI/FCI 70-3.



EN 334



PED-CE\*

\*Not applicable for regulators with pilot series 210

# Pilot ranges and types

Type	Model	Operation	Range Wh		Spring Table web link
			MPa	barg	
Main pilot	204/A	Manual	0.03 - 4.3	0.3 - 43	<a href="#">TT 433</a>
Main pilot	205/A	Manual	2 - 6	20 - 60	<a href="#">TT 799</a>
Main pilot	207/A	Manual	4.1 - 7.4	41 - 74	<a href="#">TT 1146</a>
Main pilot	214/A	Manual	0.03 - 4.3	0.3 - 43	<a href="#">TT 433</a>
Main pilot	215/A*	Manual	2 - 6	20 - 60	<a href="#">TT 799</a>
Main pilot	217/A*	Manual	4.1 - 7.4	41 - 74	<a href="#">TT 1146</a>

\* In attesa

**Table 3** Settings table

Pilot adjustment	
Pilot type .../A	Manual setting
Pilot type .../D	Electric remote control setting
Pilot type .../CS	Pneumatic remote control setting
Pilot type .../MP	Magnetic pilot for remote control setting / flow limitation

**Table 4** Pilot adjustment table

General link to the calibration tables: [PRESS HERE](#) or use the QR code:



PILOT 204/A							
Spring part number	Spring color	d	Lo	De	Spring range (psig)		
					Min.	Max.	
US2701260	White	3.5	60	35	4.4	17.4	
US2701530	Yellow	4	60	35	10.2	40.6	
US2702070	Orange	5	60	35	21.8	101.5	
US2702450	Red	6	60	35	58.0	203.0	
US2702815	Green	7	60	35	116.0	290.1	
US2703220	Black	8	60	35	217.5	478.6	
US2703420	Blue	8.5	60	35	319.1	623.6	

**d** = Wire Diameter (mm)    **Lo** = Spring Length (mm)    **De** = External Diameter (mm)

**Table 5** TT 433 - PILOT 204/A setting springs

PILOT 205/A							
Spring part number	Spring color	d	Lo	De	Spring range (psig)		
					Min.	Max.	
US2702820	Blue	7	100	35	290.1	449.6	
US2703045	Brown	7.5	100	35	406.1	667.2	
US2703224	Grey	8	100	35	580.1	870.2	

**d** = Wire Diameter (mm)    **Lo** = Spring Length (mm)    **De** = External Diameter (mm)

**Table 6** TT 799 - PILOT 205/A setting springs

PILOT 207/A							
Spring part number	Spring color	d	Lo	De	Spring range (psig)		
					Min.	Max.	
US2703224	Grey	8	100	35	594.6	1073.2	

**d** = Wire Diameter (mm)    **Lo** = Spring Length (mm)    **De** = External Diameter (mm)

**Table 7** TT 1146 - PILOT 207/A setting springs

# Accessories

## For the pressure regulators:

- Cg limiter
- Limit switches
- Position transmitter
- Silencer
- Slam shut valve
- Monitor

## For the pilot circuit:

- R14/A/S preregulator for the high pressure circuit (differential pressure > 3.5 MPa | 507.6 psig)
- Heating cable for preheating pilot circuit
- Electrical heater PPH200
- Supplementary filter CF14 or CF14/D
- ESD filter CF/5/S
- ATF 15 antifreeze

## In-line Monitor

The in-line monitor is generally installed upstream of the active regulator.

Although the function of the monitor regulator is different, the two regulators are virtually identical from the point of view of their mechanical components.

The only difference is that the monitor is set at a higher pressure than active regulator.

The Cg coefficient of the active regulator is the same, however during the sizing process, the differential pressure drop generated by the fully open in-line monitor shall be considered. As a general practise to incorporate this effect, a 20% reduction of the Active regulator's Cg value can be applied.

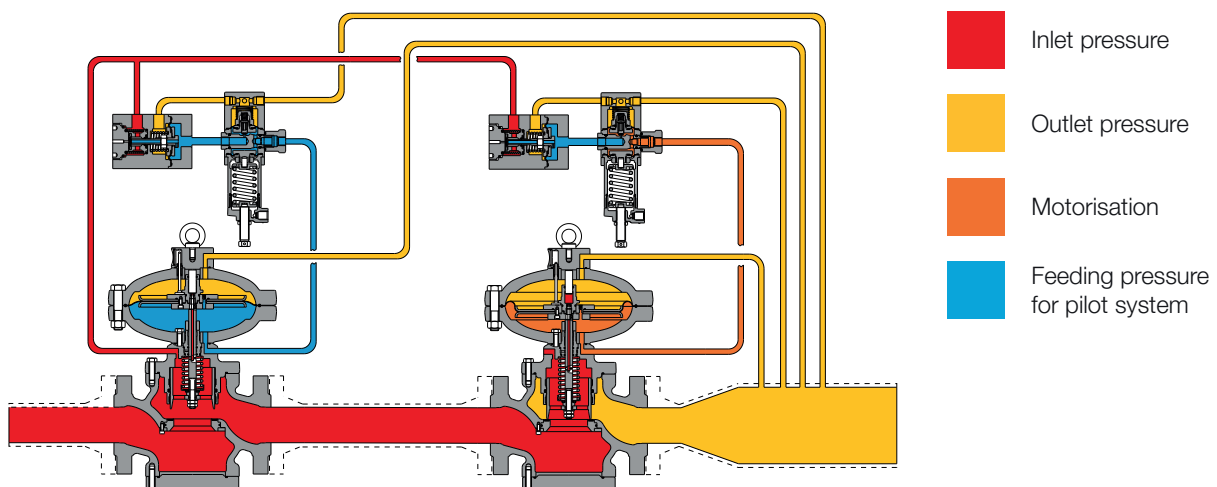

Figure 5 Reflux 819 inline monitor

# PM/819 monitor

This emergency regulator (monitor) is directly integrated onto the body of the main regulator. Both pressure regulators, therefore, use the same valve body, although they have independent actuators, pilots and valve seats.









The monitor is in the fully open position during normal operation of the active regulator and takes over on in the event of its failure.

The operational characteristics of the PM/819 monitor are the same as the Reflux 819 regulator (refer to that specific catalogue).

The Cg coefficients of regulator having an incorporated monitor is 5% lower than those for standard version.

This solution allows the construction of pressure reduction lines with compact dimensions.

Another great advantage offered by the incorporated monitor regulator is that **it can be installed at any time**, even on an existing regulator, **without major changes to the pipeline.**

-  Compact dimensions
-  Completely independent
-  Fail to close action
-  Built-in pilot's filter
-  Visual opening indicator
-  Easy maintenance
-  Limit switch option
-  Accelerator option

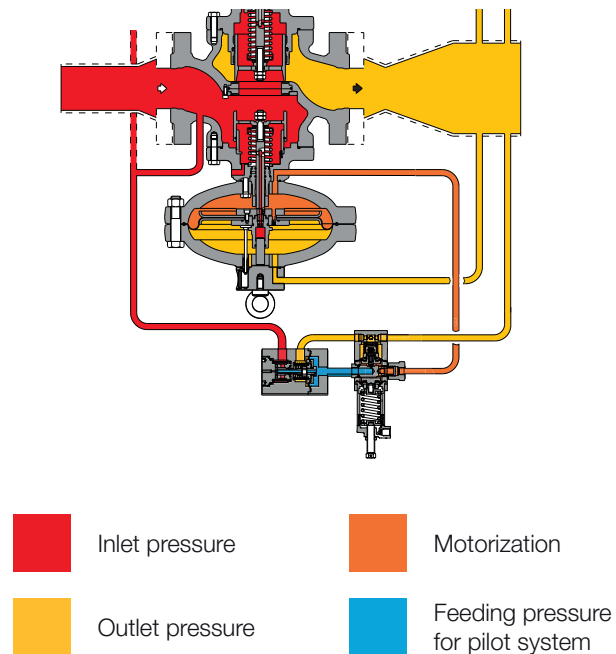

**Figure 6** Reflux 819 with PM/819



Type	Model	Operation	Range Wh		Spring Table web link
			MPa	psig	
Main pilot	204/A	Manual	0.03 - 4.3	4.35 - 623	<a href="#">TT 433</a>
Main pilot	205/A	Manual	2 - 6	290 - 870	<a href="#">TT 799</a>
Main pilot	207/A	Manual	4.1 - 7.4	595 - 1073	<a href="#">TT 1146</a>

**Table 8** Settings table

Types of pilot adjustment	
Pilot type .../A	Manual setting
Pilot type .../D	Electric remote control setting
Pilot type .../CS	Pneumatic remote control setting
Pilot type .../MP	Magnetic pilot for remote control setting / flow limitation

**Table 9** Pilot adjustment table

The monitor regulator can be equipped with an additional pilot called “Accelerating valve” to enable a quick response time during the monitor take over. According to PED the Accelerating valve is required on the monitor when acting as a safety accessory.

Type	Model	Operation	Range Wh		Spring Table web link
			MPa	barg	
Accelerating valve	M/A	Manual	0.03 - 2	0.3 - 20	<a href="#">TT 354</a>
Accelerating valve	M/A1	Manual	2 - 6.3	20 - 63	<a href="#">TT 892</a>
Accelerating valve	M/A2	Manual	4 - 7.5	40 - 75	<a href="#">TT 892</a>

**Table 10** Accelerating valve adjustment table

General link to the calibration tables: [PRESS HERE](#) or use the QR code:



PILOT 204/A							
Spring part number	Spring color	d	Lo	De	Spring range (psig)		
					Min.	Max.	
US2701260	White	3.5	60	35	4.4	17.4	
US2701530	Yellow	4	60	35	10.2	40.6	
US2702070	Orange	5	60	35	21.8	101.5	
US2702450	Red	6	60	35	58.0	203.0	
US2702815	Green	7	60	35	116.0	290.1	
US2703220	Black	8	60	35	217.5	478.6	
US2703420	Blue	8.5	60	35	319.1	623.6	

**d** = Wire Diameter (mm)   **Lo** = Spring Length (mm)   **De** = External Diameter (mm)

**Table 11** TT 433 - PILOT 204/A setting springs

PILOT 205/A							
Spring part number	Spring color	d	Lo	De	Spring range (psig)		
					Min.	Max.	
US2702820	Blue	7	100	35	290.1	449.6	
US2703045	Brown	7.5	100	35	406.1	667.2	
US2703224	Grey	8	100	35	580.1	870.2	

**d** = Wire Diameter (mm)   **Lo** = Spring Length (mm)   **De** = External Diameter (mm)

**Table 12** TT 799 - PILOT 205/A setting springs

PILOT 207/A							
Spring part number	Spring color	d	Lo	De	Spring range (psig)		
					Min.	Max.	
US2703224	Grey	8	100	35	594.6	1073.2	

**d** = Wire Diameter (mm)   **Lo** = Spring Length (mm)   **De** = External Diameter (mm)

**Table 13** TT 1146 - PILOT 207/A setting springs

M/A ACCELERATING VALVE							
Spring part number	Spring color	d	Lo	De	Spring range (psig)		
					Min.	Max.	
US2701260	White	3.5	60	35	4.4	17.4	
US2701530	Yellow	4	60	35	10.2	40.6	
US2702070	Orange	5	60	35	21.8	101.5	
US2702450	Red	6	60	35	58.0	203.0	
US2702815	Green	7	60	35	116.0	290.1	
US2703220	Black	8	60	35	246.6	435.1	
US2703420	Blue	8.5	60	35	362.6	580.1	

**d** = Wire Diameter (mm)   **Lo** = Spring Length (mm)   **De** = External Diameter (mm)

**Table 14** TT 354 - M/A ACCELERATING VALVE setting springs



**M/A ACCELERATING VALVE**

Spring part number	Spring color	d	Lo	De	Spring range (psig)	
					Min.	Max.
US2701260	White	3.5	60	35	4.4	17.4
US2701530	Yellow	4	60	35	10.2	40.6
US2702070	Orange	5	60	35	21.8	101.5
US2702450	Red	6	60	35	58.0	203.0
US2702815	Green	7	60	35	116.0	290.1

**d** = Wire Diameter (mm)   **Lo** = Spring Length (mm)   **De** = External Diameter (mm)

**Table 15** TT 354 - M/A ACCELERATING VALVE setting springs

**M/A1 ACCELERATING VALVE**

Spring part number	Spring color	d	Lo	De	Spring range (psig)	
					Min.	Max.
US2702820	Blue	7	100	35	290.1	507.6
US2703045	Brown	7.5	100	35	435.1	652.6
US2703224	Grey	8	100	35	580.1	913.7

**d** = Wire Diameter (mm)   **Lo** = Spring Length (mm)   **De** = External Diameter (mm)

**Table 16** TT 892 - M/A1 ACCELERATING VALVE setting springs

**M/A2 ACCELERATING VALVE**

Spring part number	Spring color	d	Lo	De	Spring range (psig)	
					Min.	Max.
US2703224	Grey	8	100	35	580.1	1102.2

**d** = Wire Diameter (mm)   **Lo** = Spring Length (mm)   **De** = External Diameter (mm)

**Table 17** TT 892 - M/A2 ACCELERATING VALVE setting springs



## DB/819 silencer

Whenever certain noise limit is desired, an additional silencer allows to considerably reduce the noise level (dBA).

Reflux 819 pressure regulator can be supplied with an **incorporated silencer** in either the standard version or version with incorporated slam shut or monitor regulator.

The high efficiency noise absorption takes place at the point where the noise is generated, thus preventing its propagation.

With the built-in silencer, the  $C_g$  valve coefficient is 5% lower than the corresponding version without.

Given the modular arrangement of the regulator, the silencer may be retrofitted to both standard Reflux 819 version as well as those with incorporated slam shut or monitor, **without modifying the main piping**.

Pressure reduction and control operate the same manner as standard version.

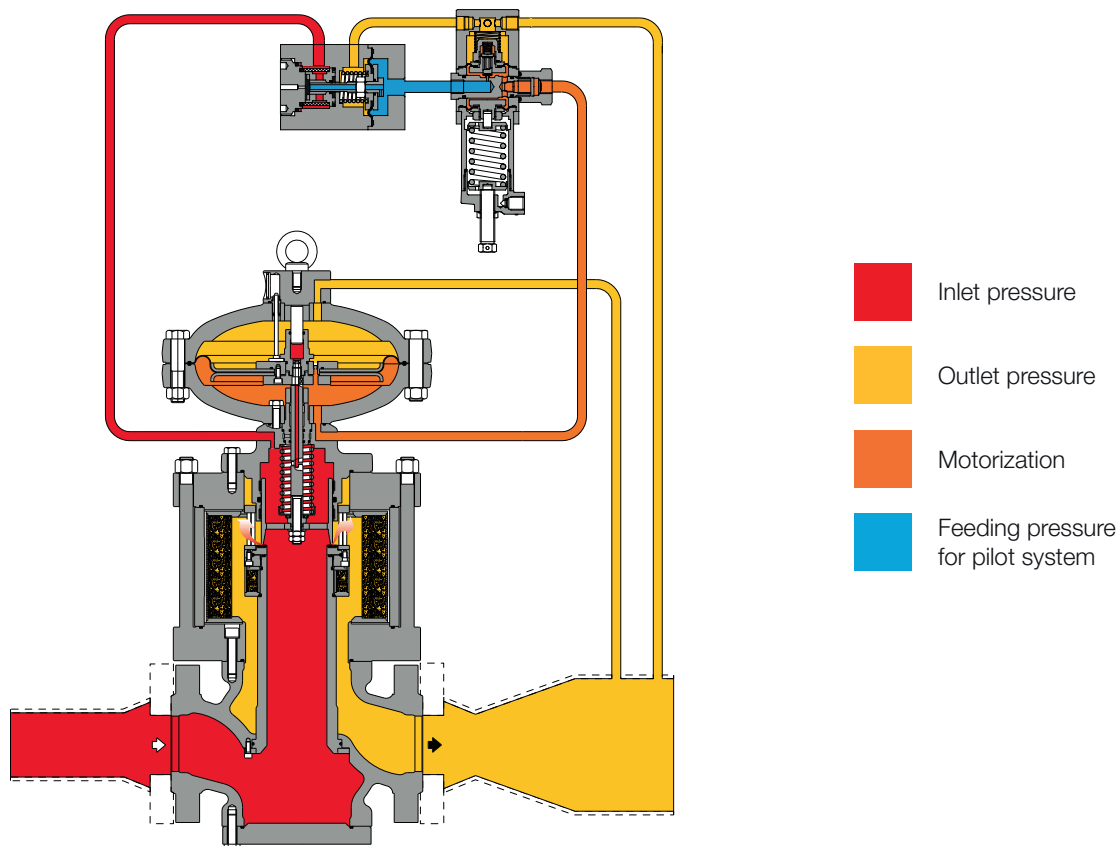

**Figure 7** Reflux 819 with DB/819 silencer

# High - Medium Pressure Gas Regulator



The charts below represent the silencer effectiveness based on some common reference conditions for 2", 4" and 6". For actual calculations at specific desired conditions please refer to the online sizing tool or contact your closest Pietro Fiorentini representative.

- Pd 0.4 MPa | 4 barg NO Silencer
- Pd 2 MPa | 20 barg NO SILENCER
- Pd 4 MPa | 40 barg NO Silencer
- ..... Recommended noise limit (85 dBA at 1 mt | 3 feet)
- Pd 0.4 MPa | 4 barg DB/819
- Pd 2 MPa | 20 barg DB/819
- Pd 4 MPa | 40 barg DB/819

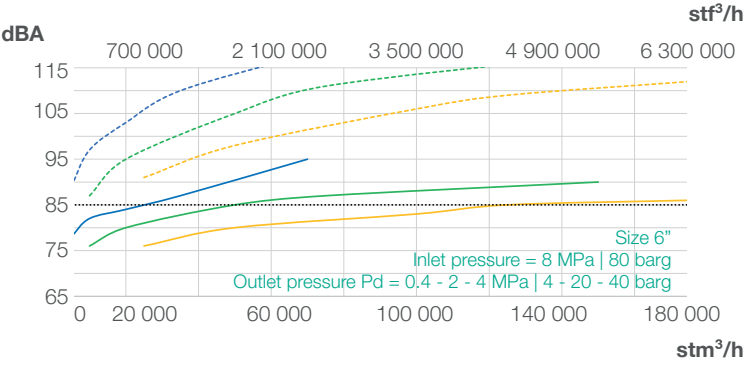
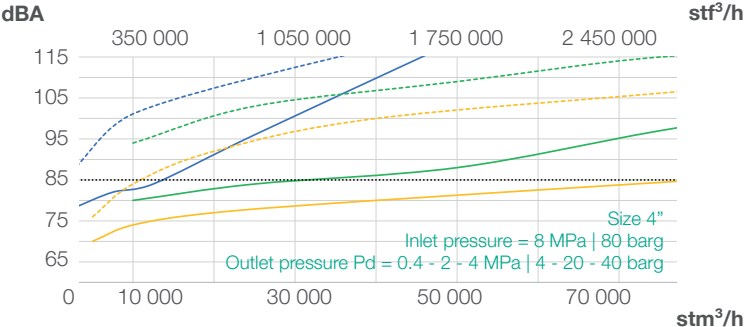
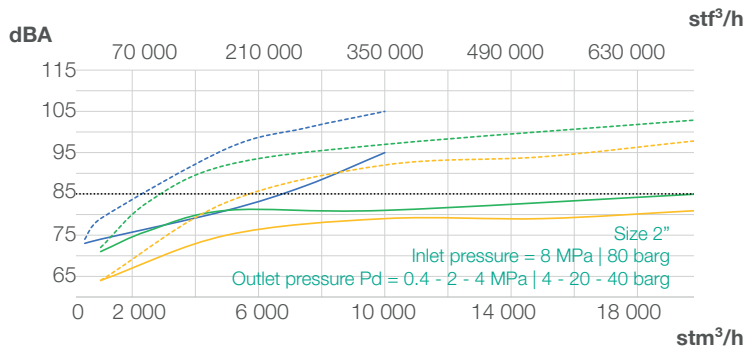
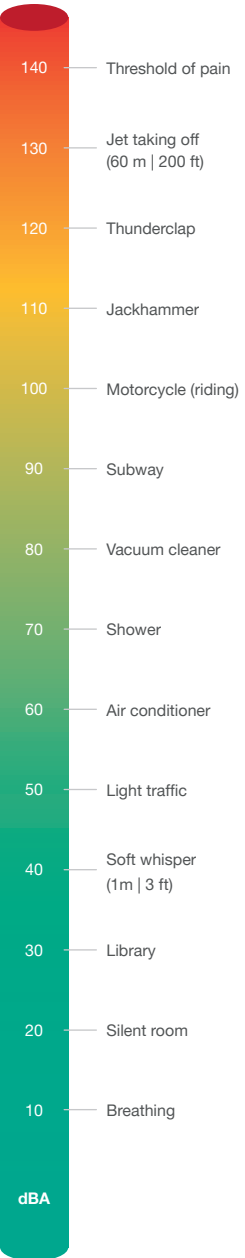

Chart 1 Reflux 819's silencer efficiency charts

## SB/82 or HB/97 slam shut









Reflux 819 pressure regulator offers the possibility of installing an **SB/82 or HB/97 incorporated slam shut valve**, depending on the regulator size, and this can be done either during the manufacturing process or be retrofitted in the field.

SB/82 is available for all sizes, while HB/97 is available from 4" to 12" only.

**Retrofitting can be done without modifying** the pressure regulator assembly.

With the built-in slam shut, the Cg valve coefficients is 5% lower than the corresponding version without.

The main characteristics of this device are:

-  Over Pressure Shut-Off
-  Under Pressure Shut-Off
-  Internal by-pass
-  Push button for tripping test
-  Compact dimensions
-  Easy maintenance
-  Remote tripping option
-  Limit switch option

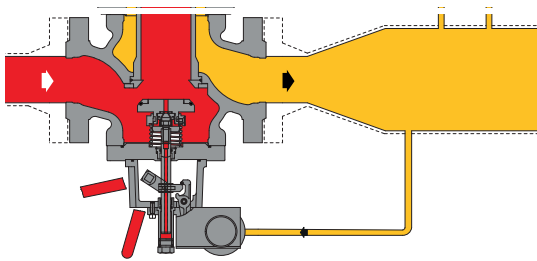

**Figure 8** Reflux 819 with SB/82

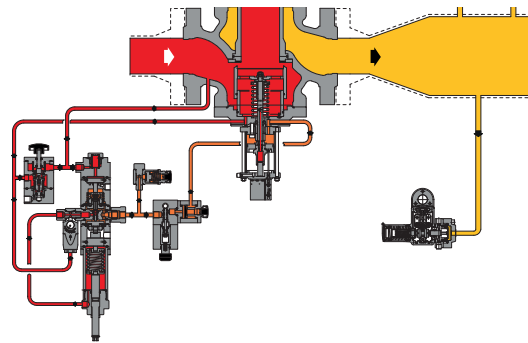

**Figure 9** Reflux 819 with HB/97

-  Inlet pressure
-  Motorization
-  Outlet pressure



Pressure switch types and ranges					
SSV Type	Model	Operation	Range Wh		Spring Table web link
			MPa	psig	
SB/82	102M	OPSO	0.02 - 0.55	2.9 - 79.8	<a href="#">TT 1331</a>
		UPSO	0.02 - 0.28	2.9 - 40.6	
SB/82	102MH	OPSO	0.02 - 0.55	2.9 - 79.8	<a href="#">TT 1331</a>
		UPSO	0.28 - 0.55	40.6 - 79.8	
SB/82	103M	OPSO	0.2 - 2.2	29.0 - 319.1	<a href="#">TT 1331</a>
		UPSO	0.02 - 0.8	2.9 - 116.0	
SB/82	103MH	OPSO	0.2 - 2.2	29.0 - 319.1	<a href="#">TT 1331</a>
		UPSO	0.8 - 1.9	116.0 - 275.6	
SB/82	104M	OPSO	1.5 - 4.5	217.6 - 652.7	<a href="#">TT 1331</a>
		UPSO	0.16 - 1.8	23.2 - 216.1	
SB/82	104MH	OPSO	1.5 - 4.5	217.6 - 652.7	<a href="#">TT 1331</a>
		UPSO	1.8 - 4.1	216.1 - 594.7	
SB/82	105M	OPSO	3 - 9	435.1 - 1305	<a href="#">TT 1331</a>
		UPSO	0.3 - 4.4	43.5 - 638.2	
SB/82	105MH	OPSO	3 - 9	435.1 - 1305	<a href="#">TT 1331</a>
		UPSO	4.4 - 9	638.2 - 1305	
HB/97	103	OPSO	0.13 - 1.1	18.9 - 159.5	<a href="#">TT 984</a>
		UPSO	0.04 - 0.68	5.8 - 98.6	
HB/97	104	OPSO	1 - 3.15	145.0 - 456.9	<a href="#">TT 984</a>
		UPSO	0.1 - 2.06	14.5 - 298.8	
HB/97	105	OPSO	2.5 - 7.6	362.6 - 1102	<a href="#">TT 985</a>
		UPSO	0.25 - 5	362.6 - 725.2	
HB/97	105/92	OPSO	5.8 - 8.5	841.2 - 1232	<a href="#">TT 985</a>
		UPSO	4.5 - 7.5	652.7 - 1087	

**Table 18** Settings table

General link to the calibration tables: [PRESS HERE](#) or use the QR code:



**Mod. 102M/102MH - Max pressure**

Spring part number	Spring color	d	Lo	De	Spring range (psig)	
					Min.	Max.
US2701260	White	3.5	60	35	2.2	14.4
US2701530	Yellow	4	60	35	8.1	28.3
US2701790	Yellow/Black	4.5	60	35	14.5	47.9
US2702280	White/Red	5.5	60	35	27.6	97.2

**d** = Wire Diameter (mm)   **Lo** = Spring Length (mm)   **De** = External Diameter (mm)

**Table 19** TT 1331 - Mod. 102M/102MH - Max pressure setting springs

**Mod. 102M - Min pressure**

Spring part number	Spring color	d	Lo	De	Spring range (psig)	
					Min.	Max.
US2700513	Red	2	40	15	0.7	3.6
US2700713	Green	2.3	40	15	2.2	7.7
US2700750	Black	2.5	40	15	3.8	19.6
US2700985	Brown	3	40	15	8.7	40.6

**d** = Wire Diameter (mm)   **Lo** = Spring Length (mm)   **De** = External Diameter (mm)

**Table 20** TT 1331 - Mod. 102M - Min pressure setting springs

**Mod. 102MH - Min pressure**

Spring part number	Spring color	d	Lo	De	Spring range (psig)	
					Min.	Max.
US2700985	Brown	3	40	15	40.6	65.3
US2700980	Blue	3	35	15		
US2700985	Brown	3	40	15	58.0	79.8
US2700986	Brown	3	40	15		

**d** = Wire Diameter (mm)   **Lo** = Spring Length (mm)   **De** = External Diameter (mm)

**Table 21** TT 1331 - Mod. 102MH - Min pressure setting springs

**Mod. 103M/103MH - Max pressure**

Spring part number	Spring color	d	Lo	De	Spring range (psig)	
					Min.	Max.
US2701530	Yellow	4	60	35	26.1	65.3
US2701790	Yellow/Black	4.5	60	35	40.6	116.0
US2702280	White/Red	5.5	60	35	95.7	224.8
US2702450	Red	6	60	35	174.0	333.6

**d** = Wire Diameter (mm)   **Lo** = Spring Length (mm)   **De** = External Diameter (mm)

**Table 22** TT 1331 - Mod. 103M/103MH - Max pressure setting springs

## High - Medium Pressure Gas Regulator



### Mod. 103M - Min pressure

Spring part number	Spring color	d	Lo	De	Spring range (psig)	
					Min.	Max.
US2700464	Orange	1.7	40	15	2.2	9.4
US2700513	Red	2	40	15	4.4	13.8
US2700713	Green	2.3	40	15	8.7	26.1
US2700750	Black	2.5	40	15	23.2	60.9
US2700985	Brown	3	40	15	56.6	116.0

**d** = Wire Diameter (mm)   **Lo** = Spring Length (mm)   **De** = External Diameter (mm)

**Table 23** TT 1331 - Mod. 103M - Min pressure setting springs

### Mod. 103MH - Min pressure

Spring part number	Spring color	d	Lo	De	Spring range (psig)	
					Min.	Max.
US2700985	Brown	3	40	15	116.0	188.5
US2700980	Blue	3	35	15		
US2700985	Brown	3	40	15	188.5	275.6
US2700986	Brown	3	40	15		

**d** = Wire Diameter (mm)   **Lo** = Spring Length (mm)   **De** = External Diameter (mm)

**Table 24** TT 1331 - Mod. 103MH - Min pressure setting springs

### Mod. 104M/104MH - Max pressure

Spring part number	Spring color	d	Lo	De	Spring range (psig)	
					Min.	Max.
US2702280	White/Red	5.5	60	35	203.0	478.6
US2702450	Red	6	60	35	348.1	696.2

**d** = Wire Diameter (mm)   **Lo** = Spring Length (mm)   **De** = External Diameter (mm)

**Table 25** TT 1331 - Mod. 104M/104MH - Max pressure setting springs

### Mod. 104M - Min pressure

Spring part number	Spring color	d	Lo	De	Spring range (psig)	
					Min.	Max.
US2700713	Green	2.3	40	15	20.3	50.8
US2700750	Black	2.5	40	15	36.3	123.3
US2700985	Brown	3	40	15	116.0	275.6

**d** = Wire Diameter (mm)   **Lo** = Spring Length (mm)   **De** = External Diameter (mm)

**Table 26** TT 1331 - Mod. 104M - Min pressure setting springs

**Mod. 104MH - Min pressure**

Spring part number	Spring color	d	Lo	De	Spring range (psig)	
					Min.	Max.
US2700985	Brown	3	40	15	261.1	435.1
US2700980	Blue	3	35	15		
US2700985	Brown	3	40	15	435.1	594.6
US2700985	Brown	3	40	15		

**d** = Wire Diameter (mm)   **Lo** = Spring Length (mm)   **De** = External Diameter (mm)

**Table 27** TT 1331 - Mod. 104MH - Min pressure setting springs

**Mod. 105M/105MH - Max pressure**

Spring part number	Spring color	d	Lo	De	Spring range (psig)	
					Min.	Max.
US2702280	White/Red	5.5	60	35	391.6	1015.2
US2702450	Red	6	60	35	812.2	1450.3

**d** = Wire Diameter (mm)   **Lo** = Spring Length (mm)   **De** = External Diameter (mm)

**Table 28** TT 1331 - Mod. 105M/105MH - Max pressure setting springs

**Mod. 105M - Min pressure**

Spring part number	Spring color	d	Lo	De	Spring range (psig)	
					Min.	Max.
US2700713	Green	2.3	40	15	29.0	123.3
US2700750	Black	2.5	40	15	58.0	275.6
US2700985	Brown	3	40	15	116.0	638.1

**d** = Wire Diameter (mm)   **Lo** = Spring Length (mm)   **De** = External Diameter (mm)

**Table 29** TT 1331 - Mod. 105M - Min pressure setting springs

**Mod. 105MH - Min pressure**

Spring part number	Spring color	d	Lo	De	Spring range (psig)	
					Min.	Max.
US2700985	Brown	3	40	15	638.1	870.2
US2700980	Blue	3	35	15		
US2700985	Brown	3	40	15	870.2	1305.3
US2700985	Brown	3	40	15		

**d** = Wire Diameter (mm)   **Lo** = Spring Length (mm)   **De** = External Diameter (mm)

**Table 30** TT 1331 - Mod. 105MH - Min pressure setting springs

## High - Medium Pressure Gas Regulator



### Mod. 103 - Max pressure

Spring part number	Spring color	d	Lo	De	Spring range (psig)	
					Min.	Max.
US2701260	White	3.5	60	35	18.9	29.0
US2701530	Yellow	4	60	35	29.0	52.2
US2701790	Yellow/Black	4.5	60	35	52.2	87.0
US2702070	Orange	5	60	35	87.0	108.8
US2702280	White/Red	5.5	60	35	108.8	159.5

**d** = Wire Diameter (mm)   **Lo** = Spring Length (mm)   **De** = External Diameter (mm)

**Table 31** TT 984 - Mod. 103 - Max pressure setting springs

### Mod. 103 - Min pressure

Spring part number	Spring color	d	Lo	De	Spring range (psig)	
					Min.	Max.
US2700513	Red	2	40	15	5.8	14.5
US2700713	Green	2.3	40	15	14.5	26.1
US2700750	Black	2.5	40	15	26.1	39.2
US2700985	Brown	3	40	15	39.2	98.6

**d** = Wire Diameter (mm)   **Lo** = Spring Length (mm)   **De** = External Diameter (mm)

**Table 32** TT 984 - Mod. 103 - Min pressure setting springs

### Mod. 104 - Max pressure

Spring part number	Spring color	d	Lo	De	Spring range (psig)	
					Min.	Max.
US2701790	Yellow/Black	4.5	60	35	145.0	217.5
US2702070	Orange	5	60	35	217.5	261.1
US2702280	White/Red	5.5	60	35	261.1	456.9

**d** = Wire Diameter (mm)   **Lo** = Spring Length (mm)   **De** = External Diameter (mm)

**Table 33** TT 984 - Mod. 104 - Max pressure setting springs

### Mod. 104 - Min pressure

Spring part number	Spring color	d	Lo	De	Spring range (psig)	
					Min.	Max.
US2700513	Red	2	40	15	14.5	36.3
US2700713	Green	2.3	40	15	36.3	65.3
US2700750	Black	2.5	40	15	65.3	98.6
US2700985	Brown	3	40	15	98.6	298.8

**d** = Wire Diameter (mm)   **Lo** = Spring Length (mm)   **De** = External Diameter (mm)

**Table 34** TT 984 - Mod. 104 - Min pressure setting springs



**Mod. 105 - Max pressure**

Spring part number	Spring color	d	Lo	De	Spring range (psig)	
					Min.	Max.
US2701790	Yellow/Black	4.5	60	35	362.6	536.6
US2702070	Orange	5	60	35	536.6	652.6
US2702280	White/Red	5.5	60	35	652.6	1102.2

**d** = Wire Diameter (mm)   **Lo** = Spring Length (mm)   **De** = External Diameter (mm)

**Table 35** TT 985 - Mod. 105 - Max pressure setting springs

**Mod. 105 - Min pressure**

Spring part number	Spring color	d	Lo	De	Spring range (psig)	
					Min.	Max.
US2700513	Red	2	40	15	36.3	87.0
US2700713	Green	2.3	40	15	87.0	159.6
US2700750	Black	2.5	40	15	159.6	239.3
US2700985	Brown	3	40	15	239.3	725.2

**d** = Wire Diameter (mm)   **Lo** = Spring Length (mm)   **De** = External Diameter (mm)

**Table 36** TT 985 - Mod. 105 - Min pressure setting springs

**Mod. 105/92 - Max pressure**

Spring part number	Spring color	d	Lo	De	Spring range (psig)	
					Min.	Max.
US2702290	Red	5.5	100	35	841.2	1232.8

**d** = Wire Diameter (mm)   **Lo** = Spring Length (mm)   **De** = External Diameter (mm)

**Table 37** TT 985 - Mod. 105/92 - Max pressure setting springs

**Mod. 105/92 - Min pressure**

Spring part number	Spring color	d	Lo	De	Spring range (psig)	
					Min.	Max.
US2701182	Blue	3.4	40	15	652.6	1087.7

**d** = Wire Diameter (mm)   **Lo** = Spring Length (mm)   **De** = External Diameter (mm)

**Table 38** TT 985 - Mod. 105/92 - Min pressure setting springs



## Pilot series 210 fail to open (optional)

The pilot series 210/A is a mechanical device which enables the working principle and the setpoint modifications of pilot operated gas pressure regulators. The pilot is optimized to enhance the accuracy and minimize the lock-up.

This model specifically allow to have a **fail-to-open regulator in case of pilot's failure**.

The pilot series 210/A is not certified for PED-CE applications.

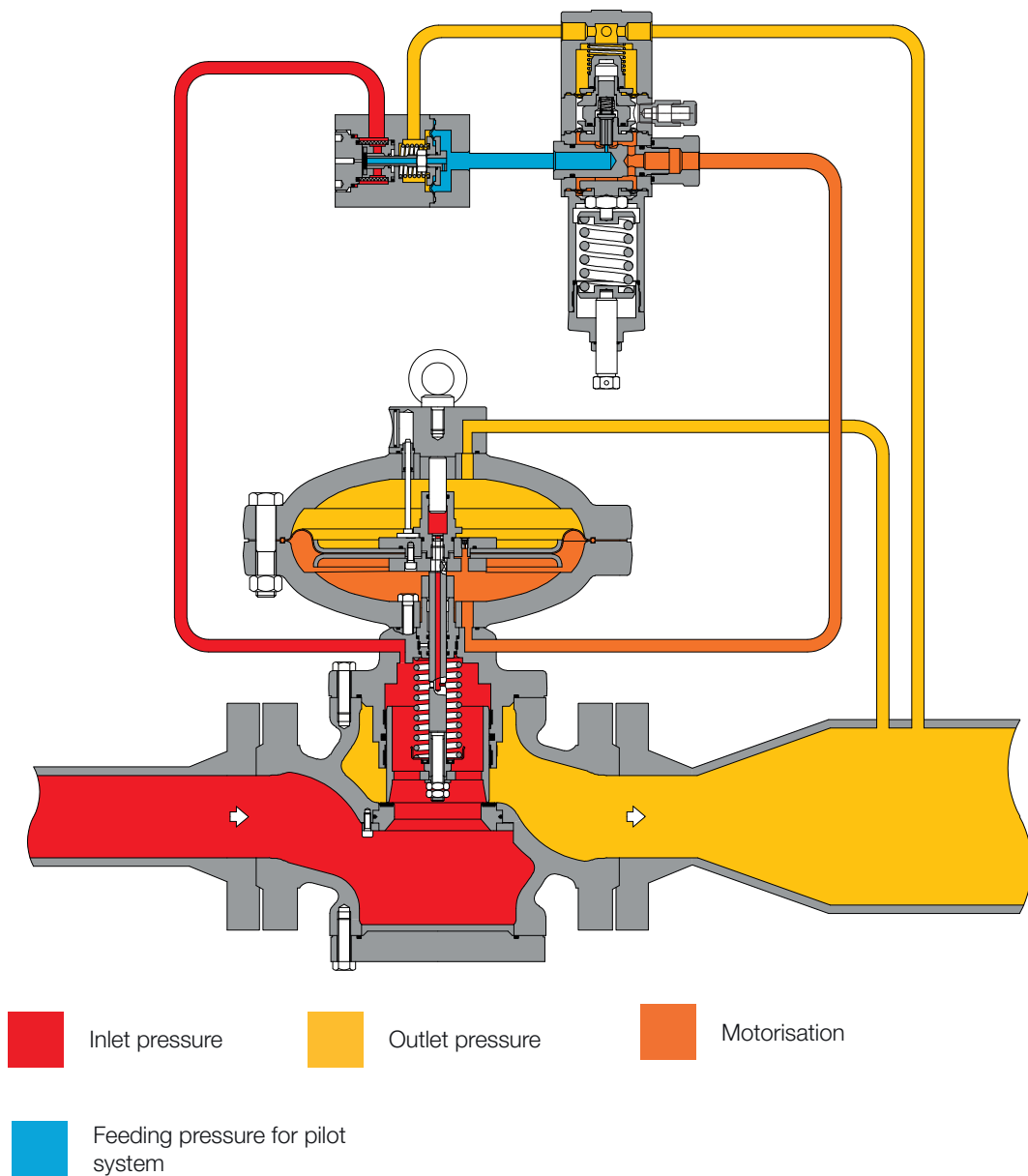

**Figure 10** Reflux 819 with fail to open pilot series 210

# Weights and Dimensions

## Reflux 819

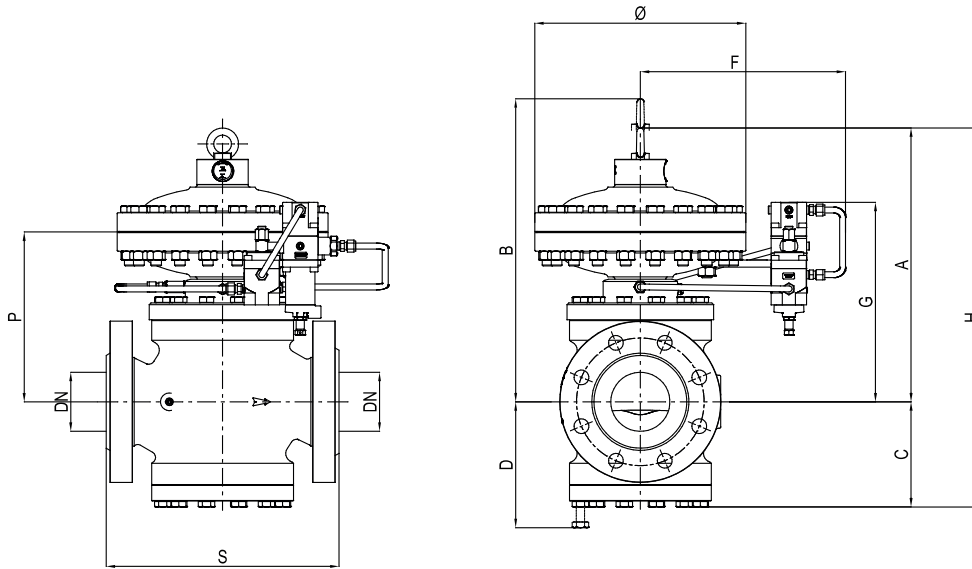

**Figure 11** Reflux 819 dimensions

Weights and Dimensions (for other connections please contact your closest Pietro Fiorentini representative)

	[mm]   inches	[mm]   inches	[mm]   inches	[mm]   inches	[mm]   inches	[mm]   inches	[mm]   inches	[mm]   inches
Size (DN)	25   1"	50   2"	80   3"	100   4"	150   6"	200   8"	250   10"	300   12"
S - ANSI 150/PN 16	184   7.25"	254   10"	298   11.75"	352   13.88"	451   17.75"	543   21.38"	673   26.50"	737   29"
S - ANSI 300	197   7.75"	267   10.5"	317   12.5"	368   14.5"	473   18.62"	568   22.38"	708   27.88"	775   30.5"
S - ANSI 600	210   8.25"	286   11.25"	336   13.25"	394   15.5"	508   20"	609   24"	752   29.62"	819   32.25"
Ø	278   1.94"	278   10.94"	360   14.17"	360   14.17"	510   20.08"	510   20.08"	610   24.02"	718   28.27"
A	320   12.59"	350   13.78"	430   16.93"	490   19.29"	650   25.59"	750   29.53"	800   31.50"	950   37.40"
B	410   16.14"	430   16.93"	530   20.87"	600   23.62"	735   28.94"	850   33.46"	900   35.43"	1195   47.05"
C	100   3.93"	130   5.12"	150   5.90"	190   7.48"	225   8.86"	265   10.43"	340   13.39"	372   14.65"
D	130   5.11"	160   6.30"	200   7.87"	250   9.84"	275   10.83"	320   12.59"	440   17.32"	475   18.70"
F	310   12.20"	310   12.20"	320   12.60"	320   12.60"	420   16.54"	420   16.54"	470   18.50"	500   19.68"
G	260   10.23"	290   11.42"	350   13.78"	380   14.96"	410   16.14"	460   18.11"	560   22.05"	645   35.39"
H	420   16.53"	480   18.90"	580   22.83"	680   26.77"	875   34.45"	1015   39.96"	1140   44.88"	1322   52.05"
P	170   6.79"	200   7.87"	260   10.24"	290   11.42"	320   12.59"	370   14.57"	500   19.68"	630   24.80"
Tube Connections	Øe 10 x Øi 8 (on request imperial sizing)							

Weight	Kg   lbs	Kg   lbs	Kg   lbs	Kg   lbs	Kg   lbs	Kg   lbs	Kg   lbs	Kg   lbs
ANSI 150/PN 16	44   97	61   134	105   231	146   322	308   679	408   899	900   1984	1335   2943
ANSI 300	45   99	62   137	109   240	156   344	345   761	470   1036	950   2094	1410   3108
ANSI 600	46   101	64   141	112   247	165   364	360   794	495   1091	1000   2204	1490   3285

**Table 39** Weights and dimensions

# Reflux 819 + SB/82 or HB/97

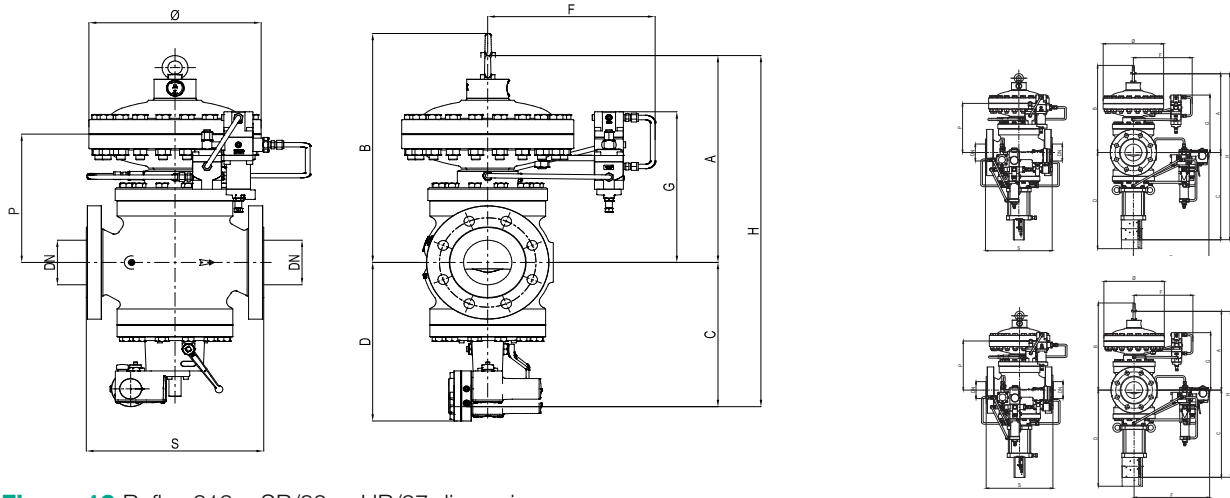

**Figure 12** Reflux 819 + SB/82 or HB/97 dimensions

Weights and Dimensions (for other connections please contact your closest Pietro Fiorentini representative)								
	[mm]   inches	[mm]   inches	[mm]   inches	[mm]   inches	[mm]   inches	[mm]   inches	[mm]   inches	[mm]   inches
Size (DN)	25   1"	50   2"	80   3"	100   4"	150   6"	200   8"	250   10"	300   12"
S - ANSI 150/PN16	184   7.25"	254   10"	298   11.75"	352   13.88"	451   17.75"	543   21.38"	673   26.50"	737   29"
S - ANSI 300	197   7.75"	267   10.5"	317   12.5"	368   14.5"	473   18.62"	568   22.38"	708   27.88"	775   30.5"
S - ANSI 600	210   8.25"	286   11.25"	336   13.25"	394   15.5"	508   20"	609   24"	752   29.62"	819   32.25"
Ø	278   1.94"	278   10.94"	360   14.17"	360   14.17"	510   20.08"	510   20.08"	610   24.02"	718   28.27"
A	320   12.59"	350   13.78"	430   16.93"	490   19.29"	650   25.59"	750   29.53"	800   31.50"	950   37.40"
B with SB/82	410   16.14"	430   16.93"	530   20.87"	600   23.62"	735   28.94"	850   33.46"	900   35.43"	-
B with HB/97	-	-	-	-	-	-	-	1135   44.68"
C with SB/82	260   10.23"	265   10.43"	295   11.61"	325   12.79"	400   15.75"	450   17.72"	530   20.87"	-
C with HB/97	-	-	-	518   20.39"	645   25.39"	687   27.05"	796   31.34"	940   37.01"
D with SB/82	280   11.02"	330   12.99"	380   14.96"	440   17.32"	560   22.05"	625   24.61"	730   28.74"	-
D with HB/97	-	-	-	650   25.59"	835   32.87"	900   35.43"	1060   41.7"	1250   49.2"
F with SB/82	310   12.20"	310   12.20"	320   12.60"	320   12.60"	420   16.54"	420   16.54"	470   18.50"	-
F with HB/97	-	-	-	358   14.09"	410   16.14"	445   17.52"	510   20.08"	530   20.87"
G with SB/82	260   10.23"	290   11.42"	350   13.78"	380   14.96"	410   16.14"	460   18.11"	560   22.05"	-
G with HB/97	-	-	-	-	-	-	-	644   25.35"
H with SB/82	535   21.06"	590   23.23"	700   27.56"	790   31.10"	1025   40.3"	1200   47.24"	1330   52.36"	-
H with HB/97	-	-	-	1008   39.7"	1295   50.9"	1437   56.6"	1596   62.83"	1890   74.41"
P with SB/82	170   6.79"	200   7.87"	260   10.24"	290   11.42"	320   12.59"	370   14.57"	500   19.68"	-
P with HB/97	-	-	-	-	-	-	-	603   23.74"
Tubing Connections	Øe 10 x Øi 8 (on request imperial sizing)							

Weight	Kg   lbs	Kg   lbs	Kg   lbs	Kg   lbs	Kg   lbs	Kg   lbs	Kg   lbs	Kg   lbs
ANSI 150/PN 16 with SB/82	53   117	71   157	115   254	160   353	320   705	460   1014	950   2094	-
ANSI 150/PN 16 with HB/97	-	-	-	150   331	310   683	414   913	894   1971	1615   3560
ANSI 300 with SB/82	55   121	73   161	122   269	171   377	365   805	525   1157	1000   2205	-
ANSI 300 with HB/97	-	-	-	179   394	406   895	558   1230	1079   2379	1690   3725
ANSI 600 with SB/82	56   123	75   165	125   276	180   397	380   838	550   1213	1050   2315	-
ANSI 600 with HB/97	-	-	-	191   421	432   952	584   1287	1099   2423	1770   3902

**Table 40** Weights and dimensions

# Reflux 819 + PM/819

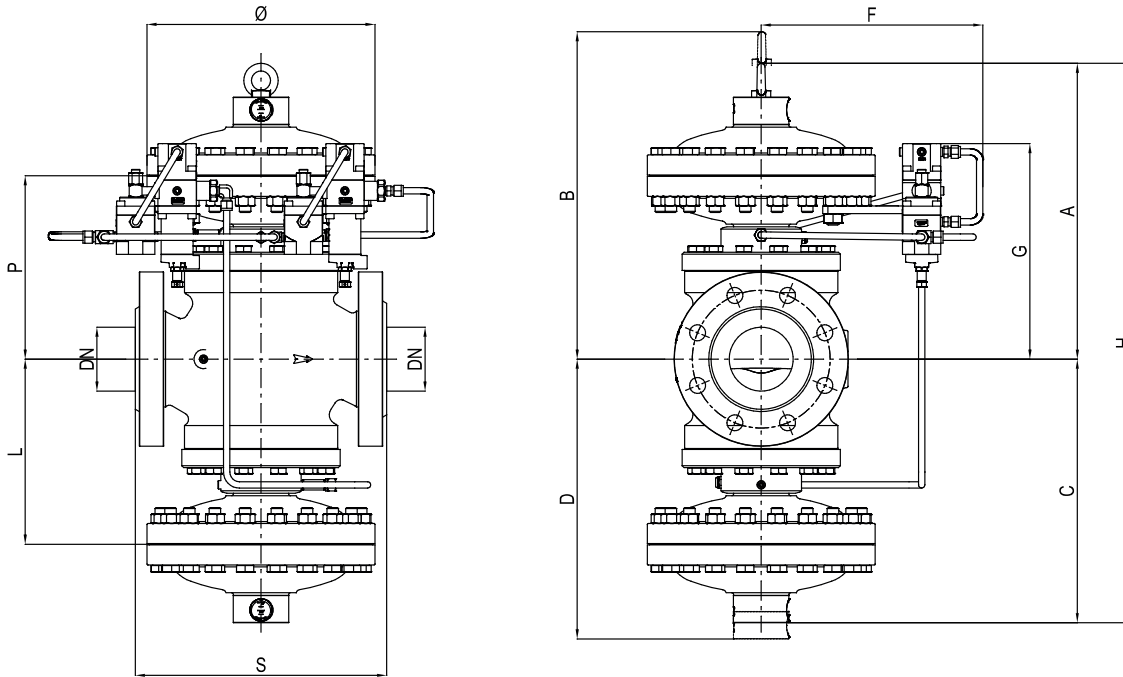
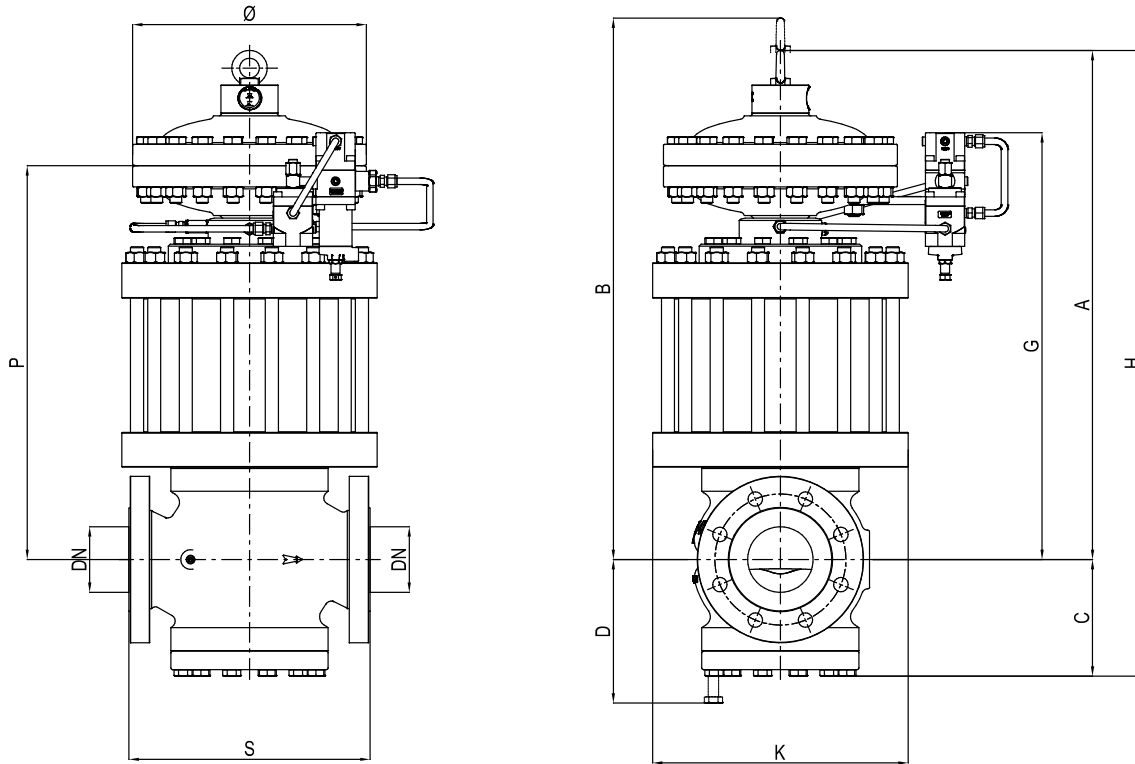

**Figure 13** Reflux 819 + PM/819 dimensions

Weights and Dimensions (for other connections please contact your closest Pietro Fiorentini representative)							
	[mm]   inches	[mm]   inches	[mm]   inches	[mm]   inches	[mm]   inches	[mm]   inches	[mm]   inches
Size (DN)	25   1"	50   2"	80   3"	100   4"	150   6"	200   8"	250   10"
S - ANSI 150/PN 16	184   7.25"	254   10"	298   11.75"	352   13.88"	451   17.75"	543   21.38"	673   26.50"
S - ANSI 300	197   7.75"	267   10.5"	317   12.5"	368   14.5"	473   18.62"	568   22.38"	708   27.88"
S - ANSI 600	210   8.25"	286   11.25"	336   13.25"	394   15.5"	508   20"	609   24"	752   29.62"
Ø	278   10.94"	278   10.94"	360   14.17"	360   14.17"	510   20.07"	510   20.07"	610   24.01"
A	320   12.59"	350   13.67"	430   16.92"	490   19.29"	650   25.59"	750   29.52"	800   31.49"
B	410   16.14"	430   16.92"	530   20.86"	600   23.62"	735   28.93"	850   33.46"	900   35.43"
C	320   12.59"	350   13.77"	430   16.92"	490   19.29"	650   25.59"	750   29.52"	800   31.49"
D	410   16.14"	430   16.92"	530   20.86"	600   23.62"	735   28.93"	850   33.46"	900   35.43"
F	310   12.20"	310   12.20"	320   12.59"	320   12.59"	420   16.53"	420   16.53"	470   18.50"
G	260   10.23"	290   11.41"	350   13.77"	380   14.96"	410   16.14"	460   18.11"	560   22.04"
H	640   25.19"	700   27.55"	860   33.85"	980   38.58"	1300   51.18"	1500   59.05"	1600   62.99"
P	170   6.69"	200   7.87"	260   10.23"	290   11.41"	320   12.59"	370   14.57"	500   19.68"
L	170   6.69"	200   7.87"	260   10.23"	290   11.41"	320   12.59"	370   14.57"	500   19.68"
Tubing Connections	Øe 10 x Øi 8 (on request imperial sizing)						
Weight	Kg   lbs	Kg   lbs	Kg   lbs	Kg   lbs	Kg   lbs	Kg   lbs	Kg   lbs
ANSI 150/PN 16	84   185	105   231	180   397	245   540	517   1140	670   1477	1400   3086
ANSI 300	85   187	106   234	184   406	255   562	554   1221	731   1612	1450   3197
ANSI 600	86   190	108   238	187   412	264   582	569   1254	756   1667	1500   3307

**Table 41** Weights and dimensions

# Reflux 819 + DB/819



**Figure 14** Reflux 819 + DB/819 dimensions

Weights and Dimensions (for other connections please contact your closest Pietro Fiorentini representative)								
	[mm]   inches	[mm]   inches	[mm]   inches	[mm]   inches	[mm]   inches	[mm]   inches	[mm]   inches	[mm]   inches
Size (DN)	25   1"	50   2"	80   3"	100   4"	150   6"	200   8"	250   10"	300   12"
S - ANSI 150/PN 16	184   7.25"	254   10"	298   11.75"	352   13.88"	451   17.75"	543   21.38"	673   26.50"	737   29"
S - ANSI 300	197   7.75"	267   10.5"	317   12.5"	368   14.5"	473   18.62"	568   22.38"	708   27.88"	775   30.5"
S - ANSI 600	210   8.25"	286   11.25"	336   13.25"	394   15.5"	508   20"	609   24"	752   29.62"	819   32.25"
Ø	278   1.94"	278   10.94"	360   14.17"	360   14.17"	510   20.08"	510   20.08"	610   24.02"	718   28.27"
A	520   20.47"	575   22.64"	700   27.56"	800   31.5"	935   36.81"	1085   42.72"	1300   51.18"	1505   59.25"
B	610   24.02"	640   25.20"	785   30.9"	895   35.24"	1120   44.09"	1250   49.21"	1500   59.05"	1771   69.72"
C	100   3.94"	130   5.12"	150   5.90"	190   7.48"	225   8.86"	265   10.43"	340   13.39"	372   14.65"
D	130   5.12"	160   6.30"	200   7.87"	250   9.84"	275   10.83"	320   12.60"	440   17.32"	475   18.70"
F	310   12.20"	310   12.20"	320   12.60"	320   12.60"	420   16.54"	420   16.54"	470   18.50"	500   19.68"
G	425   16.73"	495   19.49"	615   24.21"	670   26.38"	795   31.30"	895   35.24"	1100   43.31"	1220   48.03"
H	620   24.41"	705   27.76"	850   33.46"	990   38.97"	1160   45.67"	1350   53.15"	1640   64.57"	1877   73.90"
P	370   14.57"	400   15.75"	505   19.88"	585   23.03"	690   27.17"	770   30.31"	1000   39.37"	1205   47.44"
K	220   8.66"	300   11.81"	330   12.99"	390   15.35"	480   18.90"	595   23.42"	695   27.36"	745   29.33"
Tubing Connections	Øe 10 x Øi 8 (on request imperial sizing)							

Weight	Kg   lbs	Kg   lbs	Kg   lbs	Kg   lbs	Kg   lbs	Kg   lbs	Kg   lbs	Kg   lbs
ANSI 150/PN 16	70   154	126   278	195   430	260   573	565   1246	835   1841	1280   2822	2035   4486
ANSI 300	72   159	128   282	204   450	289   637	608   1340	925   2039	1380   3042	2230   4916
ANSI 600	73   161	130   287	207   456	298   657	640   1411	950   2094	1430   3152	2310   5093

**Table 42** Weights and dimensions

# Reflux 819 + DB/819 + SB/82 or HB/97

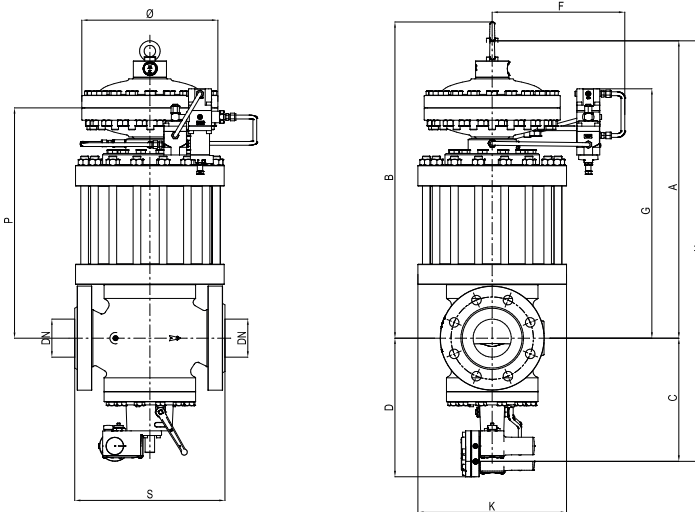

**Figure 15** Reflux 819 + DB/819 + SB/82 or HB/97 dimensions

**Weights and Dimensions (for other connections please contact your closest Pietro Fiorentini representative)**

	[mm]   inches	[mm]   inches	[mm]   inches	[mm]   inches	[mm]   inches	[mm]   inches	[mm]   inches	[mm]   inches
Size (DN)	25   1"	50   2"	80   3"	100   4"	150   6"	200   8"	250   10"	300   12"
S - ANSI 150/PN16	184   7.25"	254   10"	298   11.75"	352   13.88"	451   17.75"	543   21.38"	673   26.50"	737   29"
S - ANSI 300	197   7.75"	267   10.5"	317   12.5"	368   14.5"	473   18.62"	568   22.38"	708   27.88"	775   30.5"
S - ANSI 600	210   8.25"	286   11.25"	336   13.25"	394   15.5"	508   20"	609   24"	752   29.62"	819   32.25"
Ø	278   1.94"	278   10.94"	360   14.17"	360   14.17"	510   20.08"	510   20.08"	610   24.02"	718   28.27"
A with SB/82	520   20.47"	575   22.64"	700   27.56"	800   31.5"	935   36.81"	1085   42.72"	1300   51.18"	-
A with HB/97	-	-	-	-	-	-	-	1505   59.25"
B with SB/82	610   24.02"	640   25.20"	785   30.9"	895   35.24"	1120   44.09"	1250   49.21"	1500   59.05"	-
B with HB/97	-	-	-	-	-	-	-	1771   69.72"
C with SB/82	215   8.46"	240   9.45"	270   10.63"	300   11.81"	375   14.76"	450   17.72"	530   20.87"	-
C with HB/97	-	-	-	518   20.39"	645   25.39"	687   27.05"	796   31.34"	940   37.01"
D with SB/82	280   11.02"	330   12.99"	380   14.96"	440   17.32"	560   22.05"	625   24.60"	730   28.74"	-
D with HB/97	-	-	-	650   25.59"	835   32.87"	900   35.43"	1060   41.7"	1250   49.21"
F with SB/82	310   12.20"	310   12.20"	320   12.60"	320   12.60"	420   16.53"	420   16.53"	470   18.50"	-
F with HB/97	-	-	-	358   14.09"	410   16.14"	445   17.52"	510   20.08"	530   20.87"
G with SB/82	425   16.73"	495   19.49"	615   24.21"	670   26.38"	795   31.30"	895   35.24"	1100   43.31"	-
G with HB/97	-	-	-	-	-	-	-	1220   48.03"
H with SB/82	735   28.94"	815   32.09"	970   38.19"	1100   43.31"	1310   51.57"	1535   60.43"	1830   72.05"	-
H with HB/97	-	-	-	1318   51.89"	1580   62.20"	1772   69.76"	2096   82.52"	2445   96.26"
P	370   14.57"	400   15.75"	505   19.88"	585   23.03"	690   27.17"	770   30.31"	1000   39.37"	1205   47.44"
K	220   8.66"	300   11.81"	330   12.99"	390   15.35"	480   18.90"	595   23.42"	695   27.36"	745   29.33"
Tubing Connections	Øe 10 x Øi 8 (on request imperial sizing)							

Weight	Kg   lbs	Kg   lbs	Kg   lbs	Kg   lbs	Kg   lbs	Kg   lbs	Kg   lbs	Kg   lbs
ANSI 150/PN 16	79   174	136   300	205   452	274   604	577   1272	887   1955	1330   2932	-
ANSI 150/PN 16 with HB/97	-	-	-	266   586	569   1254	569   1254	569   1254	2315   5104
ANSI 300	82   181	139   306	217   478	304   670	628   1384	980   2161	1430   3153	-
ANSI 300 with HB/97	-	-	-	318   701	661   1457	1006   2218	1761   3882	2503   5518
ANSI 600	83   183	141   311	220   485	313   690	660   1455	1500   3307	1480   3263	-
ANSI 600 with HB/97	-	-	-	330   727	687   1515	1022   2253	1781   3926	2590   5710

**Table 43** Weights and dimensions

# Reflux 819 + DB/819 + PM/819

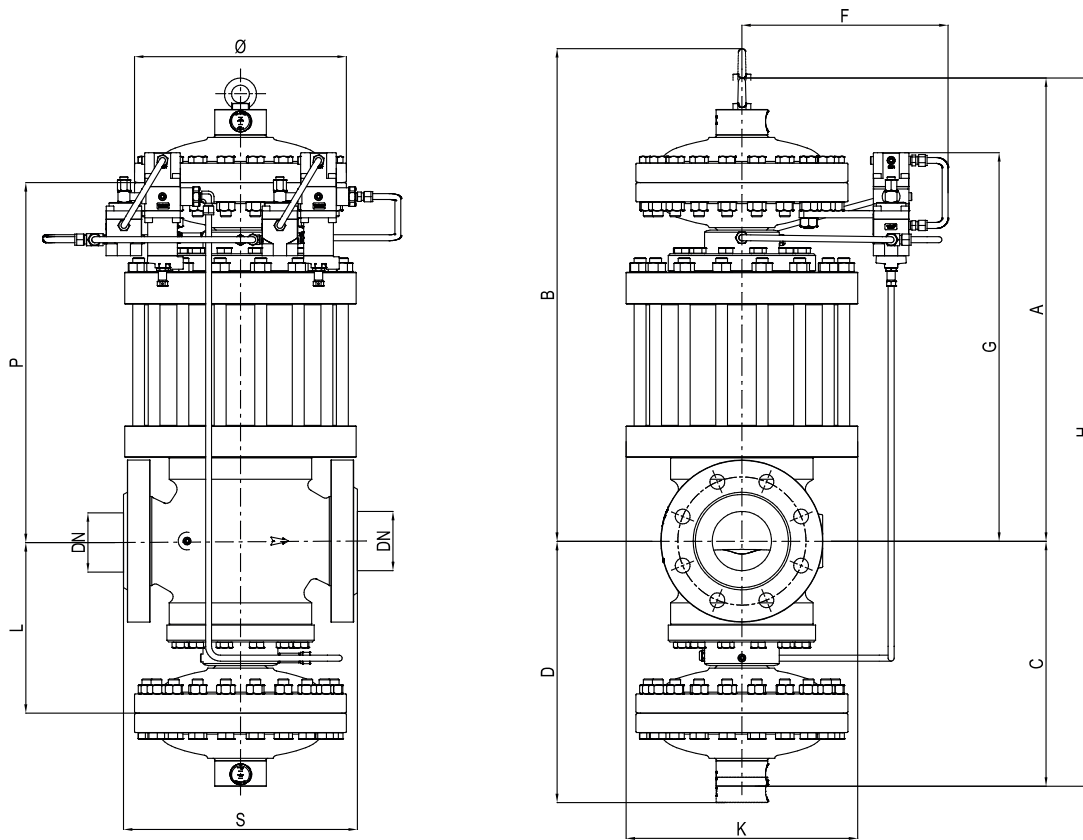

**Figure 16** Reflux 819 + DB/819 + PM/819 dimensions

Weights and Dimensions (for other connections please contact your closest Pietro Fiorentini representative)							
	[mm]   inches	[mm]   inches	[mm]   inches	[mm]   inches	[mm]   inches	[mm]   inches	[mm]   inches
Size (DN)	25   1"	50   2"	80   3"	100   4"	150   6"	200   8"	250   10"
S - ANSI 150/PN 16	184   7.25"	254   10"	298   11.75"	352   13.88"	451   17.75"	543   21.38"	673   26.50"
S - ANSI 300	197   7.75"	267   10.5"	317   12.5"	368   14.5"	473   18.62"	568   22.38"	708   27.88"
S - ANSI 600	210   8.25"	286   11.25"	336   13.25"	394   15.5"	508   20"	609   24"	752   29.62"
Ø	278   1.94"	278   10.94"	360   14.17"	360   14.17"	510   20.08"	510   20.08"	610   24.02"
A	520   20.47"	575   22.64"	700   27.56"	800   31.5"	935   36.81"	1085   42.72"	1300   51.18"
B	610   24.02"	640   25.20"	785   30.9"	895   35.24"	1120   44.09"	1250   49.21"	1500   59.05"
C	320   12.59"	350   13.78"	430   16.93"	490   19.29"	650   25.59"	750   29.53"	800   31.50"
D	410   16.14"	430   16.93"	530   20.87"	600   23.62"	735   28.94"	850   33.46"	900   35.43"
F	310   12.20"	310   12.20"	320   12.60"	320   12.60"	420   16.53"	420   16.53"	470   18.50"
G	425   16.73"	495   19.49"	615   24.21"	670   26.38"	795   31.30"	895   35.24"	1100   43.31"
H	840   33.07"	925   36.42"	1130   44.49"	1290   50.79"	1585   62.40"	1835   72.24"	2100   82.68"
L	170   6.69"	200   7.87"	260   10.24"	290   11.42"	320   12.60"	370   14.57"	500   19.68"
P	370   14.57"	400   15.75"	505   19.88"	585   23.03"	690   27.17"	770   30.31"	1000   39.37"
K	220   8.66"	300   11.81"	330   12.99"	390   15.35"	480   18.90"	595   23.42"	695   27.36"
Tube Connections	Øe 10 x Øi 8 (on request imperial sizing)						

Weight	Kg   lbs	Kg   lbs	Kg   lbs	Kg   lbs	Kg   lbs	Kg   lbs	Kg   lbs
ANSI 150/PN 16	110   242	170   375	270   595	359   791	774   1706	1097   2418	1780   3924
ANSI 300	112   247	172   379	267   588	388   855	783   1726	1185   2612	1880   4145
ANSI 600	113   249	174   383	270   595	397   875	815   1797	1210   2668	1930   4254

**Table 44** Weights and dimensions



# Sizing and Cg

In general, the choice of a regulator is made based on the calculation of the flow rate determined by the use of formulae using the flow rate coefficients (Cg) and the form factor (K1) as indicated by the EN 334 standard. Sizing available through Pietro Fiorentini’s online sizing programme.

Flow rate coefficient								
Nominal size	25	50	80	100	150	200	250	300
Inches	1"	2"	3"	4"	6"	8"	10"	12"
Cg	575	2220	4937	8000	16607	25933	36525	55000
K1	106.78	106.78	106.78	106.78	106.78	106.78	106.78	106.78

Remark: For safety relief valve sizing it is required to use the Cg values of this table regardless the accessories installed on the regulator. As per EN334 Cg value acceptance criteria these values may vary up to 10% which we recommend considering during the sizing process.

**Table 45** Flow rate coefficient

For sizing [PRESS HERE](#) or use the QR code:



**Note:** In case you do not have the proper credentials to access, feel free to contact your closest Pietro Fiorentini representative.

In general the online sizing considers multiple variables as the regulator is installed in a system, enabling a better and multiperspective approach to the sizing.

For different gases, and for natural gas with a different relative density other than 0.61 (compared to air), the correction coefficients from the following formula shall be applied:

$$F_c = \sqrt{\frac{175.8}{S \times (273.16 + T)}}$$

S = relative density (refer to Table 46)  
T = gas temperature ( °C )

$$F_c = \sqrt{\frac{316.44}{S \times (459.67 + T)}}$$

S = relative density (refer to Table 46)  
T = gas temperature ( °F )



Correction Factor Fc		
Gas Type	Relative Density S	Correction Factor Fc
Air	1.00	0.78
Propane	1.53	0.63
Butane	2.00	0.55
Nitrogen	0.97	0.79
Oxygen	1.14	0.73
Carbon Dioxide	1.52	0.63

Note: the table shows the Fc correction factors valid for Gas, calculated at a temperature of 15°C and at the declared relative density.

**Table 46** Correction Factor Fc

Flow rate conversion
Stm <sup>3</sup> /h x 0.94795 = Nm <sup>3</sup> /h

Nm<sup>3</sup>/h Reference conditions:  
 T= 0 °C; P= 1 bar(a) | T= 32 °F; P= 14.5 psi(a)  
 Stm<sup>3</sup>/h Reference conditions:  
 T= 15 °C; P= 1 bar(a) | T= 59 °F; P= 14.5 psi(a)

**Table 47** Flow rate conversion

**CAUTION:**

In order to get optimal performance, to avoid premature erosion phenomena and to limit noise emissions, it is recommended to check the gas speed and its compliance with local practice and regulations. The gas speed at the outlet flange may be calculated by means of the following formula:

$$V = 345.92 \times \frac{Q}{DN^2} \times \frac{1 - 0.002 \times Pd}{1 + Pd}$$

V = gas speed in m/s  
 Q = gas flow rate in Stm<sup>3</sup>/h  
 DN = nominal size of regular in mm  
 Pd = outlet pressure in barg

$$V = 0.0498 \times \frac{Q}{DN^2} \times \frac{14.504 - 0.002 \times Pd}{14.504 + Pd}$$

V = gas speed in ft/s  
 Q = gas flow rate in Scfh  
 DN = nominal size of regular in inches  
 Pd = outlet pressure in psi

Sizing of regulators is usually made based on valve Cg value (Table 45).

Flow rates at fully open position and various operating conditions are related by the following formulae where:

Q = flow rate in Scf/h

Pu = inlet pressure in psia

Pd = outlet pressure in psia

- **A** > when the Cg value of the regulator is known, as well as Pu and Pd, the flow rate can be calculated as follows:

- **A-1** in sub critical conditions: (Pu < 2 x Pd)

$$Q = 0.216 \times C_g \times P_u \times \sin \left( K_1 \times \sqrt{\frac{P_u - P_d}{P_u}} \right)$$

- **A-2** in critical conditions: (Pu ≥ 2 x Pd)

$$Q = 0.216 \times C_g \times P_u$$

- **B** > vice versa, when the values of Pu, Pd and Q are known, the Cg value, and hence the regulator size, may be calculated using:

- **B-1** in sub-critical conditions: (Pu < 2xPd)

$$C_g = \frac{Q}{0.216 \times P_u \times \sin \left( K_1 \times \sqrt{\frac{P_u - P_d}{P_u}} \right)}$$

- **B-2** in critical conditions (Pu ≥ 2 x Pd)

$$C_g = \frac{Q}{0.216 \times P_u}$$

**NOTE:** The sin value is understood to be DEG.



# Installations

Here below, at glance, are some typical installations by application and geographical location. On demand we are available to supply a more comprehensive experience list and/or references.



Reflux 819/FO/DB worker + Reflux 819 monitor | City gate in EMEA



Reflux 819 worker + FIO smart unit controller  
Transmission application in China

# Customer Centricity

Customer centricity is a way of running your business — implementing a perfect customer experience at each stage of the pipeline. Pietro Fiorentini is one of the main Italian international company with high focus on product and service quality.

The main strategy is to create a stable, long-term relationship, putting the customer's needs first. Lean management and customer centricity are used to improve and maintain the highest level of customer experience.



## Support

Pietro Fiorentini's top priority is to provide support to the client in all phases of project development, during installation, start up and operation. Pietro Fiorentini has developed a highly standardized Intervention-Management-System (IMS), which helps to facilitate the entire process and putting the customer at the forefront of every decision in our process while manufacturing or developing a product to help improve the product and service. With our IMS business model many services are available remotely, avoiding long waiting times, improving service, and avoiding unnecessary expenses.



## Training

Pietro Fiorentini offers training services available for both experienced operators and new customers. The training is offered for all levels of our customers which can include one or all of the following: sizing of equipment, application, installation, operation, maintenance and is prepared according to the level of use and the customer's need.



## Customer Relation Management (CRM)

The service and care of our customers are one of the main missions and vision of Pietro Fiorentini. For this reason, Pietro Fiorentini has enhanced the customer relation management system. This enables us to track every opportunity and request from our customers into one single information point and allows us to coordinate information allowing us to give the customer improved service.



# Sustainability

Here at Pietro Fiorentini, we believe in a world capable of improvement through technology and solutions that can shape a more sustainable future. That is why respect for people, society and the environment form the cornerstones of our strategy.



## Our commitment to the world of tomorrow

While in the past we limited ourselves to providing products, systems and services for the oil & gas sector, today we want to broaden our horizons and create technologies and solutions for a digital and sustainable world. We have a particular focus on renewable energy projects to help make the most of our planet's resources and create a future in which the younger generations can grow and prosper.

The time has come to understand how and why we operate now.







# Pietro Fiorentini

**TB0005USA**



The data is not binding. We reserve the right  
to make changes without prior notice.

reflux819\_technicalbrochure\_USA\_revE

[www.fiorentini-usa.com](http://www.fiorentini-usa.com)