

Hybrid meter HM10-HM16-HM25



User Manual

Edizione / Edition
0.9

Data / Date
12/01/2018

ENGLISH

Edition 0	Revision 9	Date 12/01/2018
--------------	---------------	--------------------

Index

1	Introduction	3
1.1	<i>Product identification</i>	3
2	Safety instructions.....	8
2.1	<i>Block Diagram</i>	8
2.2	<i>Remote interfaces - intrinsically safety parameters (IS)</i>	8
2.3	<i>Safety instructions for installation in the hazardous area</i>	9
2.3.1	<i>Marking</i>	10
3	General Description.....	11
4	Main Functions.....	12
4.1	<i>Acquisition</i>	12
4.2	<i>Events and Diagnostics</i>	12
4.3	<i>Calculation of Volumes</i>	13
4.3.1	<i>Conventional flow rate</i>	13
4.4	<i>Data recording</i>	13
4.5	<i>Communication</i>	14
4.6	<i>User Interface</i>	14
5	Installation	15
5.1	<i>Mechanical Installation</i>	15
5.2	<i>Connection to the system</i>	17
5.2.1	<i>Using the ZVEI Probe</i>	18
5.2.2	<i>Activation and Connection to the SAC</i>	18
5.3	<i>Power supply</i>	19
5.3.1	<i>Connecting the Batteries</i>	19
5.3.2	<i>Supply status</i>	19
5.3.3	<i>Replacing the batteries</i>	19
5.4	<i>Security and Fraud prevention</i>	20
6	User Interface	21
6.1	<i>Keyboard</i>	21
6.2	<i>Display</i>	21
6.2.1	<i>Display testing capabilities</i>	22
6.2.2	<i>Explanation field</i>	22
6.2.3	<i>Data field</i>	22
6.2.4	<i>Icons and symbols</i>	22
6.2.5	<i>Measurement units and other symbols</i>	22
7	Menu structure	24
7.1	<i>Main page</i>	24
7.2	<i>Chapters</i>	24

7.2.1	Chapter of General Parameters (GEn)	25
7.2.2	Current Billing chapter (Pt-corr)	26
7.2.3	Previous Billing chapter (Pt-PrEc)	26
7.2.4	System (APPArAtO)	26
7.2.5	Service (Ser)	27
7.3	<i>Configurability of the pages and chapters</i>	27
8	Configuration	29
9	Maintenance	30
9.1	<i>Ordinary Maintenance</i>	30
9.1.1	Battery Replacement	30
9.1.2	Calibration in the field	30
9.1.3	Firmware update	30
9.2	<i>Corrective maintenance</i>	30
9.2.1	Status of Replacement	30
9.2.2	Replacing the electronics section	30
9.2.3	Replacing the battery	31
9.2.4	Replacement of temperature and pressure probes	31
10	Technical characteristics	32
10.1	<i>General Features</i>	32
10.2	<i>Communication ports</i>	32
10.3	<i>Power Supply Devices</i>	32
10.4	<i>Output for communication to the User</i>	33
10.4.1	Interface of Pulse Emitter	34
10.4.2	Serial Communication Interface	35
10.5	<i>Value added services (VAS)</i>	36
10.5.1	VAS - Calculation of the maximum monthly conventional flow rate	36
10.5.2	VAS - Flow rate overload detection	36
10.5.3	VAS - Leaks Management	36
10.5.4	VAS - Negative volume detection	36
10.5.5	VAS - Time management in the collection range	36
10.5.6	VAS - Consumption management in the collection range	36
10.5.7	VAS - Check of the SLA	37
Annex A1	40
Annex A2	41
Annex A3	47
Annex A4	48

1 Introduction

HM is a family of products dedicated to measuring gas volume, which involves the application in end points of redelivery of natural gas networks.

This document refers to products HM10, HM16 and HM25. The family is defined as "Hybrid Meter" (HM) as it is realized with mechanical and electronic "hybrid" technology (mechatronics). The product integrates a mechanical measurement device of gas volumes and a computer that can ensure the functions envisaged by resolution AEEG 155-08, to allow the remote reading with the use of a communication module (HMCom)***. HM is forecast for use in measuring systems with pressure > 0.7 < 1,5 bar gauge with a maximum flow rate of 40cub.mt/h (Class AA1 according to the classification of UNITS 11291).

HM handles the volumes at metering conditions and volumes reported at the thermodynamic reference conditions (type of GdM AA1). This document provides information regarding the installation and use of the device.

HM has the following main features:

- Single block in plastic compact, lightweight material
- IP 65 protection
- Temperature probe and pressure sensor
- Local optical communication port complying with (physical profile) CEI EN 62056-21 (ZVEI);
- Auxiliary optical output configurable for pulse retransmission or serial communication
- LCD display
- Front key (user interface);
- Communication device that can be remotely installed (HMCom)

1.1 Product identification

The product can be identified by the label of Fig. 1 applied on the front of the device (Fig. 2). The following symbols and fields are shown

- **Model Code**
- **Serial Number**
- **Year of manufacturing**

Model Code

Code format **HM10; HM16 ; HM25**

Serial Number

Format FIO-R03- VV-YYXXXXXX

FIO Fixed data indicating the manufacturer (Pietro Fiorentini SpA) according to the Flag Association coding

R reserved

03 type of system (GAS meter)

VV version

YY year of production

XXXXXX Serial number

The forecast product versions are given here below:

Version Code "VV"	Model GdM
"07"	HM10
"08"	HM16
"09"	HM25

When ordering, you can indicate whether the product must be provided with HMCom communication system.

Packaging content

The package contains the following parts:

Device

- HM device including:
 - Battery
 - Two plugs for the protection of the connection fittings;
 - HMCom (if requested at the order)

The battery is inside the operation compartment already electrically connected.

Manual

- Quick Guide to Installation and Safety Instructions

The complete manuals are available for free download (after registration) from the website www.fiorentini.com

***:HMCom is a GSM/GPRS modem device provided with compatible optical serial interface with the gas meters produced by Fiorentini with a rating capacity of 10, 16 and 25 m³/h. According to the needs dictated by adequate GSM coverage for HMCom, two installation types are planned distinguished between:

Local installation: models HMCom and HMCom-RA (with external antenna connector)

Remote Installation: model HMCom-R

When inside the niche where the gas meter is installed there is not sufficient GSM coverage, you can install HMCom outside of this niche.

HMCom-R is the optical probe that, when connected via a cable with maximum length of 10 meters to HMCom, allows you to make the local optical communication with the gas meter.

HMCom-R uses the same container forecast for HMCom.

Please refer to the manual of HMCom for more information.

Certificates

- Certificate of UE Conformity
- Metrological certificate of first factory inspection

Below we indicate the front label with the rating data of the devices

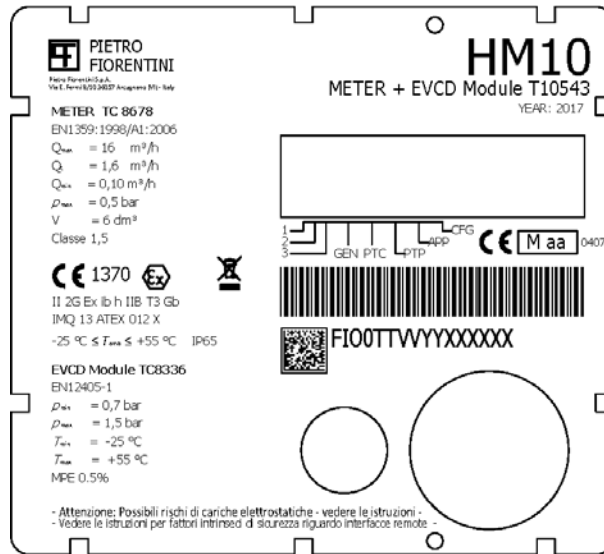

Fig.1 - Front label HM 10 -

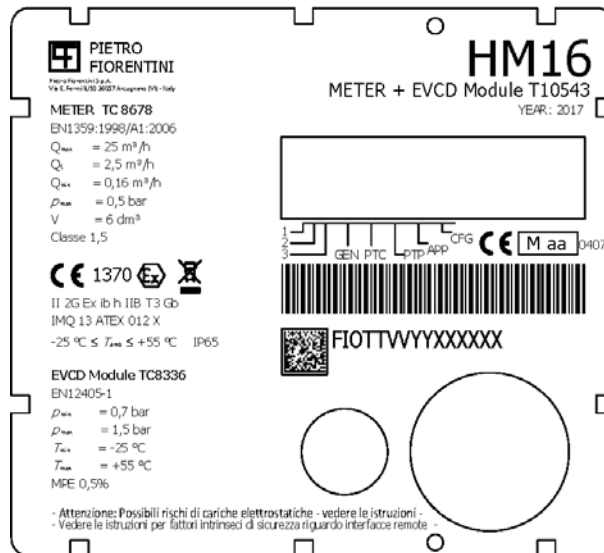

Fig.2 - Front label HM 16 -

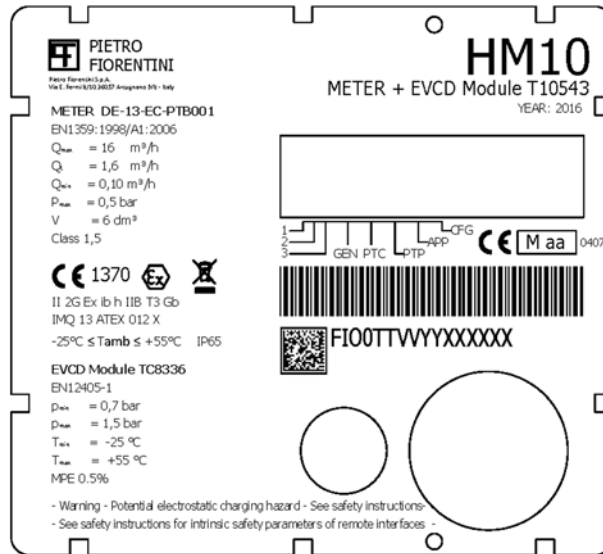

Fig.3 - Front label HM 10 –

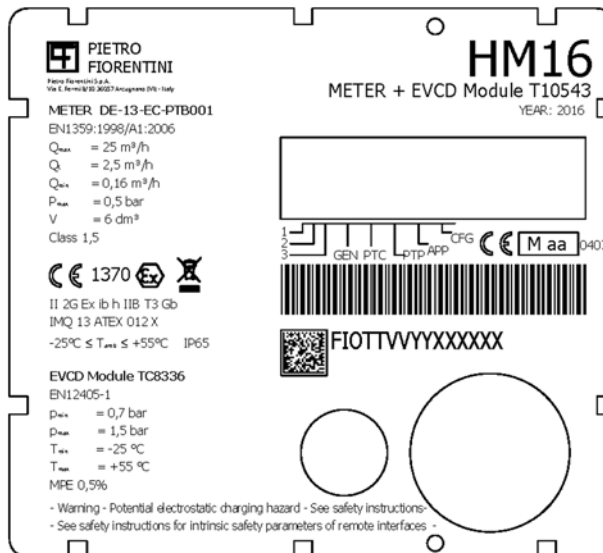

Fig.4 - Front label HM 16 –

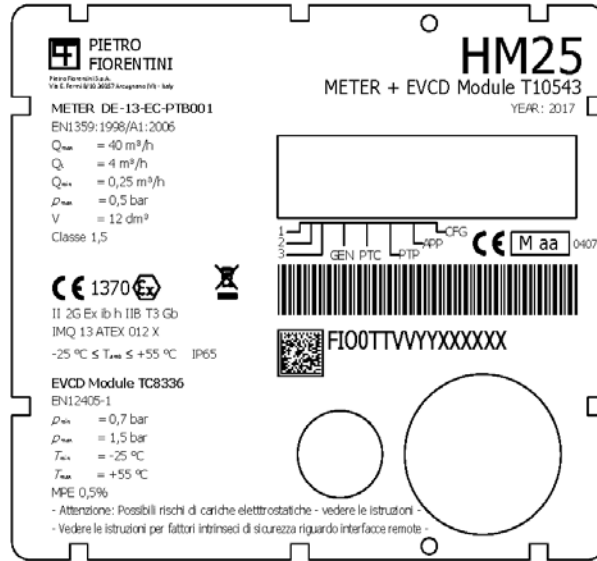

Fig.5 - Front label HM 25 -

The following table shows an overview of the device HM25-

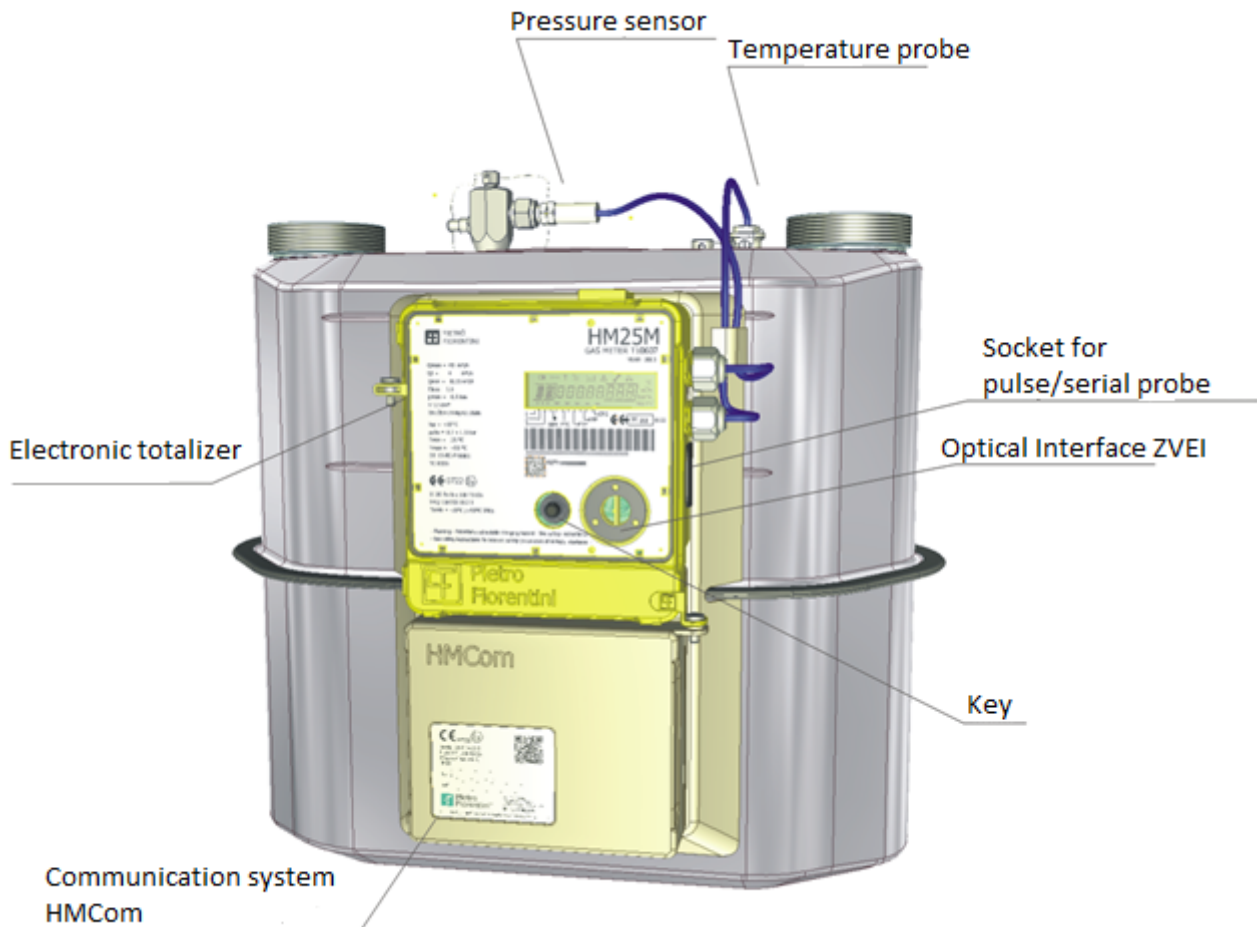

Fig.6 Overview of HM25 (the image is representative of the whole range) -

2 Safety instructions

The Hybrid Meter (HM) systems are intrinsically safe devices suitable for installation in hazardous areas classified as Zone 1, Group IIB.

The main function of HM is the measurement of gas volumes; this function is carried out mechanically inside the metal body of the system while the electronic unit makes its correction.

This section describes the safety requirements to be observed for the HM models and relating to explosion protection (ATEX).

HM complies with the requirements of the directives 2014/34/UE (ATEX) and it is classified as a system of category 2G and type of protection **Ex ib h IIB Gb**, class of temperature T3, ambient temperature from -25 °C to +55 °C

HM It is designed and manufactured in accordance with the following standards:

EN 60079-0: 2012 Electrical system for potentially explosive atmospheres. General requirements.

EN 60079-11: 2012 Electrical system for potentially explosive atmospheres. Intrinsic safety.

2.1 Block Diagram

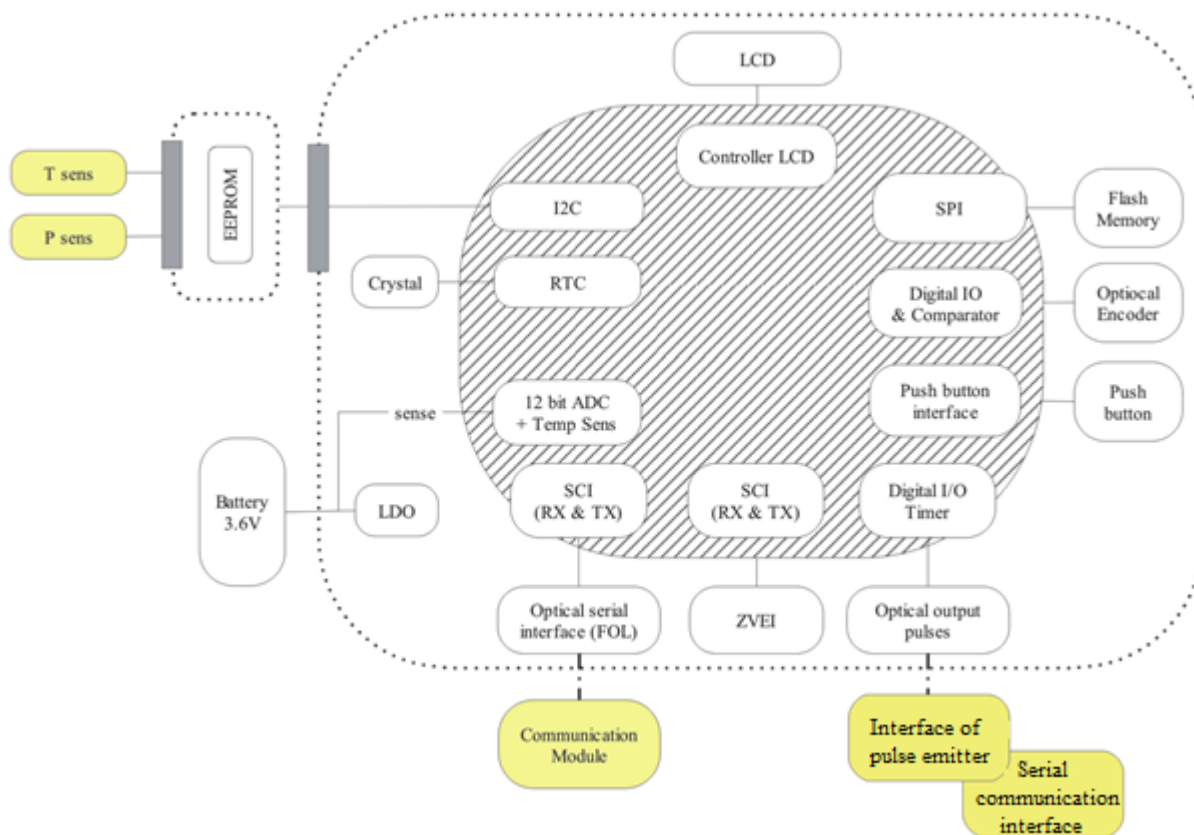

The parameters of optical interfaces are calculated in accordance with the requirements of EN60079-28

REMARK: In a typical installation, there are no external electrical connections. Possible electrical connections are available if an optional external probe is connected to the system.

2.2 Remote interfaces - intrinsically safety parameters (IS)

There is no RSE electrical connection of HM with external devices.

HM can connect, using the ZVEI optical port, to devices for the communication of data and commands useful for configuration and maintenance of the device.

HM can connect through the auxiliary optical port to:

- Proprietary probe Pietro Fiorentini for the retransmission of impulses (order code PF50A00000000SNN0000)
- Proprietary probe Pietro Fiorentini for serial communication (order code PF50A00000000SNN0001)

The intrinsically safety parameters related to remote interfaces described in section 10.4 of this document are given below:

Ui (V)	Ii (mA)	Pi (mW)	Ci (µF)	Li (mH)	Uo (V)	Io	Po (mW)	Co (µF)	Lo (mH)
--------	---------	---------	---------	---------	--------	----	---------	---------	---------

 Pietro Fiorentini®	HM10 -HM16 -HM25 User Manual							ENGLISH		

							(mA)				
Interface of Pulse Emitter	10.7	16	250	12	0	-	-	-	N.A.	N.A.	
Serial communication interface	10.4	350	1400	10.6	0	4.1	96	100	~0	~0	

2.3 Safety instructions for installation in the hazardous area

This equipment has to be installed and operated in compliance with the provisions and regulations in force.

The manufacturer cannot be liable for damages resulting from failure to follow instructions and inappropriate use.

During the operations of installation and maintenance, in order to prevent the formation of surface electric charges it is necessary to have dissipative shoes and damp cloth ($\rho\% > 65\%$).

Further information can be found in CEI TR 50404 standard.

Safety warning

All works must be performed by qualified gas personnel.

Electrical work must only be performed by qualified electricians.

Transformation of spare parts

Any technical changes are forbidden. Use only original spare parts.

Transport

As a rule, meters shall be transported being kept in vertical position.

Upon receipt of the product, examine the supplied material.

Immediately notify any shipping damage.

Storage

As a rule, meters have to be stored in vertical position and in a dry place at ambient temperature.

WARNING

To ensure the tightness of the meter:

- Do not twist, bend or manipulate in any way the taking of pressure measurement.
- During assembly, always lock the measurement socket with a suitable wrench, exerting a counterforce.
- The operating safety is only guaranteed if the coupling of the fitting material and the pressure pipe is done correctly.
- Use only the ogive ring and the corresponding clamping nut included in the supply.
- The ogive ring is secured to the sealing cap.

Before mounting the meter, check the tightness of the pipe, in case it is controlled with a test pressure higher than the max operating pressure admitted p_{max} . for the white meter. Otherwise you may cause damage to the meter installed.

- Verify that the utilities on the customer side are closed.
- Slowly load the white meter with test pressure.
- If on the meter a piping for pressure measurement has been subsequently installed, check the tightness of the related connection.
- After leak testing, slowly remove pressure to the white meter.
- If on the meter it has been subsequently installed a piping for measuring the pressure, protect the pressure measuring inlet from external interventions with a sealing cap and a seal.

Once the tightness has been checked, the meter is ready for use.

Further instructions might be necessary for a mounted totalizer. After that slowly open the ball valve.

The meters of the company Pietro Fiorentini require no maintenance.

If for maintenance or recalibration you loosen the screw connections, change the seals.

After removing the white counter, immediately close the input /output sleeves with the protective caps as there may spill dirt particles.

WARNING

When the meter is disassembled, it may contain a residual amount of gas. Considering the danger of explosion, it is necessary to take safety measures, e.g.:

- After disassembling the white meter, clean it very well with an inert gas.
- For transporting the white meter with residual amounts of gas, use a vehicle with an open or vented loading area.

Technical data

Type of gas: methane gas, town gas, propane and butane according to UNI EN 437:2003 gas from the first to the third family.

Max. operating permissible pressure $p_{max} = 0,1$ bar (fireproof version) / 0,5 bar (not fireproof version)

High temperature resistance according to EN 1359:1998+A1:2006, paragraph 6.5.5

- **Replacement of primary battery**

It is not forecast the replacement of the battery during the life of the product; for this reason, the access to the battery compartment is allowed only by using specific equipment.

If for maintenance operations it is necessary to perform the primary element replacement, the following instructions should be observed:

1. **Type of battery**

Replace only with the same model legible on the label placed on the battery pack.

2. **Hazardous area**

If the replacement occurs in the hazardous area (zone 1) you must ensure the absence of explosive atmospheres (measuring LEL through special instrument).

Before installation please read this instruction manual

2.3.1 Marking

The identification plate of products shows the relative ATEX marking, described below.

Description of the symbols related to intrinsic safety

IMQ 13 ATEX 012 X

Certificate number according to ATEX standards



CE logo (conforming device)



Logo Ex (conforming device)

II

Group II (surface)

2G

Device category 2G

Ex ib

Type of electronic module protection HM

h

Type of mechanical protection

IIB

gas group

T3

Temperature class

Gb

Protection class

Tamb: -25°C ~ +55°C

Ambient temperature range within which IS conformity is guaranteed

Zones		Categories pursuant to the Directive 2014/34/UE
Gas, mist or vapor	Zone 0	1G
Gas, mist or vapor	Zone 1	2G
Gas, mist or vapor	Zone 2	3G

Table of Categories / Zone correspondence

3 General Description

Fig. 2 illustrates the structure and the main parts of the device.

The system consists of a metal container that contains inside:

- the mechanical structure of measurement and of volumes
- the temperature and pressure pit

The system consists of two plastic containers that contain inside:

- the electronic measurement and control card
- the electronic communication card (HMCom)
- the interface card with the pressure sensor and the temperature probe
- battery

On the front of the plastic container there are:

- a segment and icon display
- one operator key;
- optical communication interface

On the right side of the plastic container there is the optical interface of retransmission of the pulses/serial

HM 25 is a measuring instrument with accuracy class 1.5 as defined in MID.

The class 1.5 provides the following measurement precision in relation to the flow rate Q with which the gas flows:

Class	1.5	HM10	HM16	HM25
$Q_{min} \leq Q < Q_t$	3%	Q_{min}= 60 litres/h ; Q_t= 1600 litres/h	Q_{min}= 100 litres/h ; Q_t= 2500 litres/h	Q_{min}= 160 litres/h ; Q_t= 4000 litres/h
$Q_t \leq Q \leq Q_{max}$	1.5%	Q_{max} = 16.000 lit/h	Q_{max} = 25.000 lit/h	Q_{max} = 40.000 lit/h

HM is a family of measuring instruments that can count the quantity of gas measured in consumption areas in relation to the time in which they were measured, in accordance with the terms of resolution 155-08 of AEEG

For this function, HM uses a clock whose precision characteristic complies with the EN16314 and the EN62054-21 standard:

±0.5 sec/day at the reference temperature

±0.15 sec/°C/24h

4 Main Functions

4.1 Acquisition

The flow measurement is carried out continuously by means of the mechanical system constituted by two measuring chambers (of well-defined volume) with deformable walls, which are filled and emptied alternately: this reciprocating motion, induced by the pressure difference between the sections of input and output, transformed with a crank mechanism, is transmitted to a small pinion that accomplishes thereby a revolution, about every 12 liters of gas in transit. The pinion is keyed to a suitably perforated disc capable of constituting an obstacle in certain positions, to the passage of infrared light.

The rotary movement of the disc is detected by an optical sensor system that can emit and detect infrared and suitably arranged so as to realize a Gray code. The Gray code allows to also detect the direction of rotation in order not to influence the measurement by any of the pinion oscillations.

The system, consisting of the pinion and optical sensors, represents the interface between the measuring mechanics and the calculation and management electronics.

The piloting and detection of the optical sensors is entrusted directly to the controlling microprocessor, which performs also an ongoing diagnostic activity to highlight any faults and fraud attempts made by blinding the sensors. The piloting of the sensors is carried out in a controlled manner, which is such as to assure proper operation during the whole HM life-cycle and to verify any malfunction.

The frequency of acquisition of volumes by the microprocessor is such as to ensure the correct acquisition of the measurement also with gas flow rates higher than the maximum which can flow through the meter (e.g.: HM25 up to over 48 cub.mt/h)

The measurements of temperature and pressure required for the calculation of the volumes at thermodynamic reference conditions, are carried out by means of suitable sensors capable of measuring with an accuracy better than ± 1 . °C in the temperature range 0-30 °C, and better than 2 °C in the outside range of up to -25 °C to + 55 °C for temperature measurement and better than 0.25%rdg @ 20 °C and 0.5%rdg in the outside range up to -25 °C to + 55 °C for that of the pressure. The sensors return the measurement in digital format.

The measurements of temperature and pressure of the gas carried by the signal generated by the sensors are acquired and updated every 30 seconds.

HM in addition to measuring the temperature of the gas implements, through an appropriate sensor, the measurement of the ambient temperature, which is useful and necessary for the calculation of energy consumed and to diagnose the correct operation of some functions. The precision with which the ambient temperature is measured is better than ± 3 °C.

The ambient temperature measurement is also used for the calculation and storage of the daily degrees or daily logs which represent the sum of the positive differences between the measured temperature and the reference value of 20 °C.

4.2 Events and Diagnostics

HM can record events in failure conditions or when specific application operations occur.

There are two logs for event logging: "metrological" and "non-metrological". The metrological events log can contain up to 500 records. The "non-metrological" event log can contain, in "cyclic queue" mode up to 250 events. Each of the registers is capable of recording the events with the following information:

- date and time at which the event occurred
- type of event
- progressive number (absolute starting from the initialization or the last total reset)
- operator identification code that generated the event (if applicable)
- in case of records relating to the modification of a metrological parameter, the new parameter value
- absolute totalizer at the time of the event

The types of events planned by UNITS 11291 and other events defined in the private area are logged. (See Annex A1).

In the metrological event log, after it is reached a capacity of 90% of the maximum, a diagnostic is activated and the corresponding event is triggered.

Once the maximum capacity has been reached, it generates a different event, and, from then on, each new event will overwrite the most recent one. All the parameter modification operations that affect the volume and flow calculations and the software update are disabled.

The metrological events log can be deleted by the user Administrator defined by the communication protocol, after removal of a logical seal dedicated for this purpose. The "non metrological" event log cannot be reset

The events are stored in an area of permanent memory.

4.3 Calculation of Volumes

The HM performs the calculation of the volumes converted to the thermodynamic conditions of reference every 30 seconds. The volume is calculated by multiplying each status of the Gray code detected by the "weight" K of the status expressed in liters: the K weight of the status is determined during the calibration and considers the "cyclic volume" of the meter, i.e. of the volume needed for the pinion to make exactly one revolution ¹.

The quantum of volume thus measured is immediately compensated for temperature and pressure.

The quantum of volume thus measured is immediately converted to the thermodynamic conditions of reference taking into account the absolute actual gas temperature and pressure.

On the basis of the quanta of volume converted, the following are calculated: the Absolute Volumes Totalizer (ToT_Vb), the Absolute Totalizer of volumes, divided by time band, the conventional hourly flow rate (see pf 4.3.1).

HM, thanks to the system used based on the Gray code, can detect and count "negative volumes" of gas. i.e. gas flows passing through the meter in the direction opposite to the normal direction. Given that these volumes are not measured with less accuracy than those that flow in the normal direction, HM recognizes and records the negative volumes in a dedicated register which makes it available on request only through the communication channels (not on display)

HM can account for and totalize the number of minutes (in multiples of 5) in which the conventional flow rate (see definition in pf. 4.3.1) was maintained within rate ranges defined by the following limits:

Totalizer	Conventional flow rate
TPF1	$\leq Q_{min}$
TPF2	$Q_{min} < Q \leq Q_t$
TPF3	$Q_t < Q \leq Q_{max}$
TPF4	$> Q_{max}$

The related totalizers are available via the communication channels; the display of flow rates: Q_{min} , Q_t and Q_{max} for totalizers TPF is configurable.

HM can record in special totalizer logs the amount of volumes of gas transiting in the measuring chamber at different flow rates. For this purpose HM uses 3 not configurable reference flow rates (Q_{min} , Q_t and Q_{max}). The flow rate used is the instantaneous one.

4.3.1 Conventional flow rate

The HM calculates the conventional hourly flow rate at reference conditions (Q_{cb}) as a sum, shifting every 5 minutes, of the transited volumes in the last quarter of an hour, reported to the hour. Every 5 minutes the calculation is repeated by eliminating the volumes of the 5 less recent minutes. The calculation is consistent with the requirements of UNI TS11291-5 standard.

4.4 Data recording

The acquired and calculated variables are entered into the device. Registration takes place on the DMP permanent memory attached to the metal body and unreachable. The retention of data in the memory is guaranteed for over 20 years. The recording is carried out in the manner and frequency stipulated by Del. 155-08 of AEEG and the UNITS 11291.

In the table are shown the recording periods and the relative depth of storage:

Period	Storage depth	Samples number
Daily	70 days	1 slot per each day
Monthly	12 months	1 slot per each month

Each period is managed in a circular manner relative to the sequence of days.

The parameters that are stored each day are the following²:

Mnemonic	Description
Vb_g	Daily volume
Vm_g	Volumes at measurement conditions
Tot_Vb_g	Totalizer of volumes at reference thermodynamic conditions

¹ HM may take into consideration up to 6 different values of K in relation to the instantaneous hourly flow rate value that the meter is measuring. The K factor used for the calculation of the actual volume is calculated through linear interpolation of 6 calibration factors set.

²For each value it is associated a qualifier indicating among other things whether the value is valid, invalid or measured while HM25 was in the maintenance state

Tot_Vm_g	Totalizer of volumes under measurement conditions
Tot_Vme_g	Totalizer of volumes at metering conditions in error
Qcb_max_g	Maximum conventional flow rate
DiagnRS_g	Historical daily diagnostic
GG_g	(Day Degrees)

Furthermore, the storage of the 12 monthly values of the following parameter is performed:

Mnemonic		Information on each record
Qcb_max_m	Maximum monthly conventional flow rate	(flow rate value, its qualifier, the instant of occurrence expressed as day, hour and minute)

For the user of the remote display management function (that can be used when the FOL output is ready in "D" mode) HM calculates and keeps track of up to 12 values of the following hourly traces:

Mnemonic	Description
Qb_h	Volumes at reference conditions
Qm_h	Volumes at measurement conditions
T_h	Measurement temperature
P_h	Measurement pressure

The recordings can still be accessed remotely or locally via the terminal connected to the ZVEI optical port

At each absolute setting of date and time, as well as upon any change of the hour of gas end of day, the records will be erased and the recording will be automatically restarted.

4.5 Communication

HM has three communication interfaces, two local ones and a remote one:

- Optical port Zvei: Infrared port built in compliance with the physical standards IEC1107; it requires an external communication device (Probe Zvei)
- Modem GSM/GPRS³ Built-in in the device, HMCom antenna included (removable)
- Optical port for connecting the retransmission probe, pulse/serial

The protocol used for remote communication and local communication via the ZVEI optical port (physical level complying with EN 62056-21) is the CTR complying with UNITS11291-3 version R 131.

The asynchronous format and the speed of communication through the ZVEI optical port are set to the following values:

velocity: 9600baud,

format: 1(start bit), 8 (data bit), N (no parity), 1 (stop bit)

The ZVEI optical port is normally turned off when the display is turned off; to activate it, it is therefore necessary to press the operator key so that it lights up. The interface remains active for 10 minutes after the last message.

4.6 User Interface

The user interface consists of an LCD display and one operator key. The interface only allows the consultation of the parameters by pressing the button. Programming is only possible through local or remote communication.

³ Optionally you can have a communicator on a wireless network at 169 MHz in accordance with UNI TS 11291-11

5 Installation

HM is suitable for installation in hazardous areas classified as Zone 1.

HM meets the protection requirements of type: II 2G[E Ex ib] IIB T3 Gb.

2G: For use in Zone 1 atmospheres; therefore, it is safe in case of operation without interferences.

It establishes the maximum ignition energy that shall not be exceeded and, therefore, with what types of gas the product can be used in a safe manner (Propane).

T3 defines the maximum allowable surface temperature equal to 200 °C.

Caution!

Before beginning with the installation, carefully read and verify the safety instructions contained in the first chapter.

5.1 Mechanical Installation

Below we indicate the overall dimensions of the models provided along with the size of the threads related to the connections to the process.

The HM10 model is available with either 250mm pitch or 280mm pitch

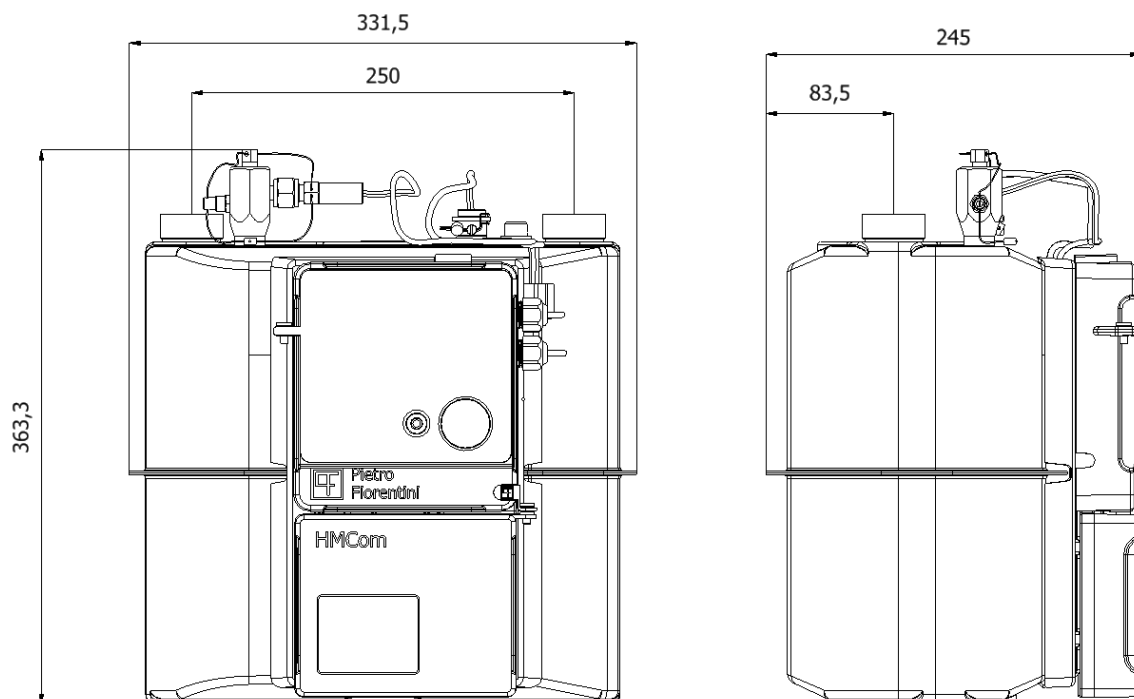

Fig.7 overall dimensions of HM10, process connection 1"1/4 ISO 228-1

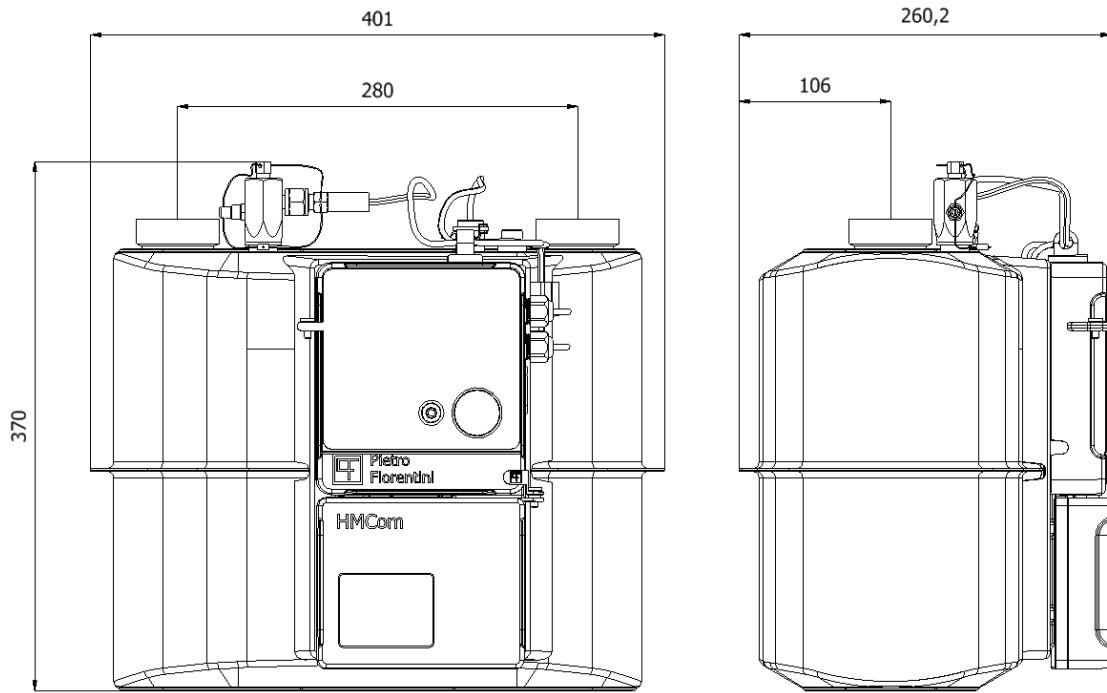

Fig.8 Overall dimensions of HM10/16, process connection 2" ISO 228-1

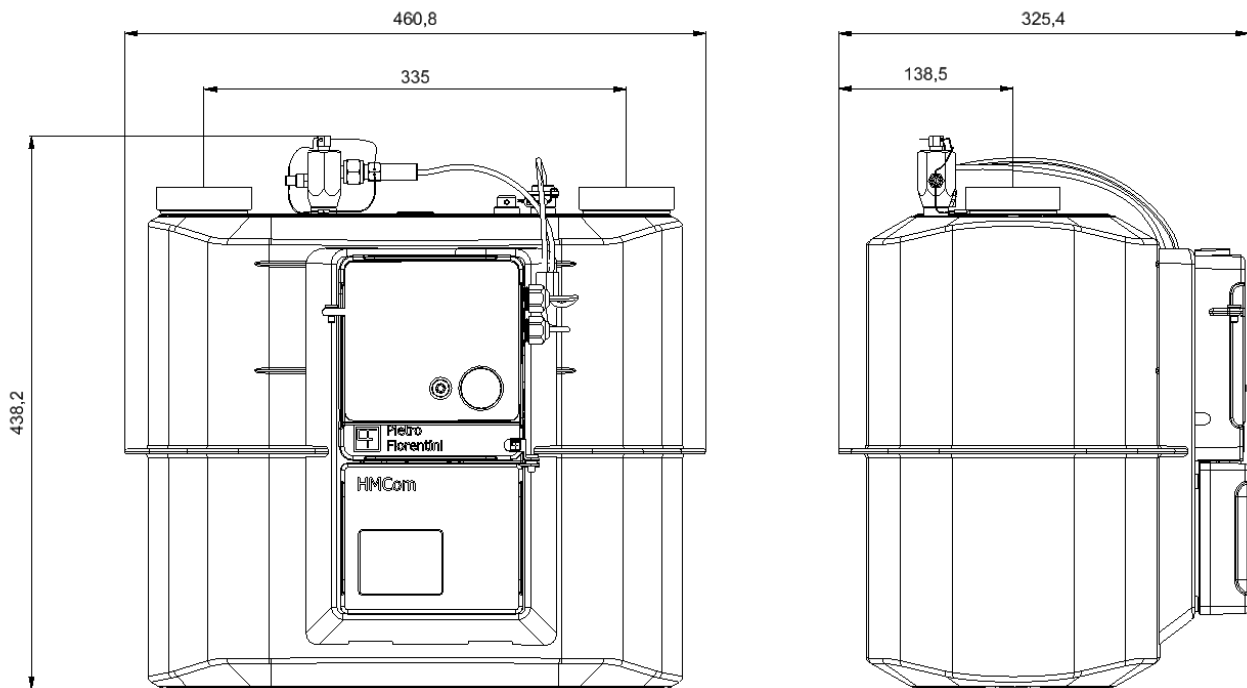

Fig.9 Overall dimensions HM25, process connection 2"1/2 ISO 228-1

5.2 Connection to the system

- After installation, HM must be connected to the system. Before connection, **make sure that at least the portion of the plant upstream the meter is sectioned** and that, therefore, there cannot be any flow of gas during the installation;
- Before connection, **make sure that the maximum system pressure** is lower than the maximum pressure set for the meter, which is fixed and equal to 0.5 relative bar.
- If necessary, use fittings (not supplied) to connect HM to the piping.
- **HM operates only in vertical position.**

After making the connections and verified the proper operation, you can insert special *user seals* to highlight attempts of tampering of the meter installation. Do not confuse the user seals with the metric seals: metric seal consists of an adhesive crushable label and shall be applied at the factory; their removal will void the metric certification (Figure 5).

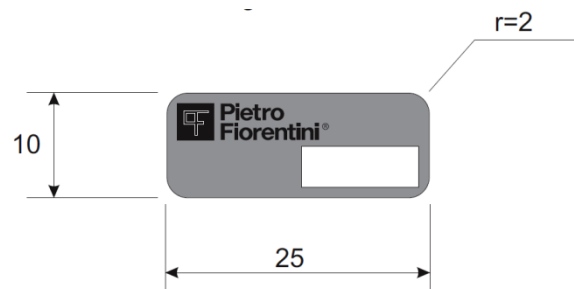

Fig. 10 - Metric Seal

5.2.1 Using the ZVEI Probe

The ZVEI probe (available as an option) is equipped with magnetic coupling. Place the probe in the provided groove on the front part of HM with the cable facing downwards (Fig. 6). The magnet and the groove will retain the Probe in place. To use the optical communication it is necessary for the display to be turned on, so press the operator button before starting communication



Fig. 11 - Attaching the Probe Zvei HM

5.2.2 Activation and Connection to the SAC

HM is already active and operating from the factory. At the factory, unless otherwise agreed, HM is configured with default parameters set by UNITS 11291. In particular:

- the status is not configured
- the rate in force is F1 (disabled tariff program)
- date and time are not configured
- the safety parameters are those set in the factory
- remote communication has been disabled

After installation, HM must be configured and, if provided, connected to SAC: the configuration and connection must be made by means of terminal Cterm-PC or equivalent

The activation involves the configuration, through the terminal, of the following parameters⁴:

- code of the redelivery point (PdR)
- date and time

The connection to the SAC foresees that HM has the references of the SAC to which it must be connected: these references can be pre-configured at the factory or be configured using X-Term; through X-Term, you must force HM to make a connection to SAC; SAC, if aware of the security credentials, can connect HM by configuring, if necessary, other parameters⁵

⁴ The introduction of parameters indicated below is optional, in case it was expected that these are configured by the SAC. However it is advisable to proceed with the configuration of the parameters indicated in the field so as to leave the measuring group fully operational, for the purposes of the contract.

⁴ The introduction of parameters indicated below is optional, in case it was expected that these are configured by the SAC. However it is advisable to proceed with the configuration of the parameters indicated in the field so as to leave the measuring group fully operational, for the purposes of the contract.

⁵ Upon the first connection it is recommended to change the operational and maintenance keys to different values than the default factory configuration

5.3 Power supply

The HM meter can be powered exclusively by batteries.

The standard configuration foresees a single battery

The battery is proportionate to ensure the HM operation for at least 15 (fifteen) years if you comply with the reference operating conditions (see par. 2.3)

HM implements and manages service quality logs, available only through the communication channels (not on the display) able to verify the deviation of the actual operating conditions from the reference ones.

5.3.1 Connecting the Batteries

HM comes with the battery already inserted in the special compartment already connected and therefore HM is ready for operation. However, to minimize consumption of the meter when it is not yet connected to the process at the factory before shipment, the system is placed in an operating state in which communication is prevented through HMCom

5.3.2 Supply status

Power status shows the level of the main battery and the battery HMCom.

It is calculated the charge status of the batteries as a function of the operations performed. The estimate of consumption also provides a correction according to the measured ambient temperature and aging (self-discharge).

The time of use data are indicated in hours and are only available through the communication channels (not on the display).

The remaining time of the two batteries (as a percentage) is visible on the display in two different menu pages

if the level of the main battery is low, the icon appears on the display



The icon has two states

- Icon lit in fixed mode. At least one battery is exhausted (remaining range <10% of the stated time)
- Lit icon is flashing. Main battery exhausted to be replaced (time below the critical point; interrupted measurement)

The status of exhausted battery is also reported in the battery diagnostics page and registered as an event and it results in the interruption of the measurement functions (see user interface).

The low battery icon will appear along with the other indications on the display only when you press the operator key

Two thresholds of charge for the main battery are defined (not applicable to the operation of the communication device battery) with respect to which the following functions are provided:

thr1: stop of remote communications functions, and repetition of the pulses; recording of an event (code 37h) with indication of the remaining battery level.

thr2: stop of the measurement and data recording functions; recording an event (37h code) indicating the residual level of autonomy and event of interruption of the measurement functions (4Bh code).

The status of the battery below the threshold *thr2* is indicated on the display by the related icon.

Below the threshold *thr2* the following remain in effect: on-screen display functions and local communication until the complete discharge of the battery. The anti-fraud functions are never interrupted (except that of blinding the optical sensors).

In addition to the autonomy verification it is forecast a verification of the main battery status through the measurement of the battery voltage itself. If the battery voltage is below a critical value considered as critical, the system behavior, (functions and signalings on the display) is the same as provided for by exceeding the threshold *thr2*. This malfunction condition (voltage lower than the cut-off limit before exceeding the estimated threshold *thr2*) determines the generation of a fault event (code 35h) and the interruption of the measurement functions (4Bh code).

5.3.3 Replacing the batteries

The HM battery is sized to assure an autonomy of more than 15 years under normal environmental and operating conditions and, therefore, it is not necessary to replace it.

If the equipment is used in operating and/or environmental conditions very different than the reference (see pf 5.3) it might happen that the battery runs out before the expected life, so you need to replace it (see section 9.2.3)

5.4 Security and Fraud prevention

HM implements all security policies defined by the reference standards and, in particular, by UNI-TS 11291-10. In detail:

- access to the electronics is not possible without removing the mechanical seal and without permanently and clearly damaging the container;
- access to the memory device is not possible without permanently and patently damaging the container;
- access to the battery is not possible without permanently and patently damaging the container;
- using interface equipment usually available to the User it is only possible to read the data and it is not possible to perform any configuration;
- the configurations that can be performed only through the communication channels with which the device is equipped - which can be carried out only by authorized personnel - leave in any case a track as they are stored in the relevant memory log, which is not erasable (Metrological Log);
- attempts to tamper with the proper functioning of the meter are detected and recorded in the Metrological Log;
- attempts to access the meter through the communication channels with which it is equipped by unauthorized personnel are detected and recorded in the Metrological Log;
- the commands sent by external devices through the communication channels with which the device is equipped are verified in terms of the source authenticity;
- the messages transmitted through the communication channels conveying sensitive information are all efficiently encrypted (AES 128)
- attempts to access the meter through the communication channels made with wrong passwords or encryption keys are detected, listed and made available to the control center;
- the duration of the operating conditions is monitored and recorded.

6 User Interface

The user interface consists of an operator key and a display. The following paragraphs describe the modes of interaction with the operator and navigation through the user interface pages.

6.1 Keyboard

The interaction occurs via a single key on the front of the device, which, as a function of the pressure duration and of the currently displayed page, can take different meanings (see subsequent sections).

6.2 Display





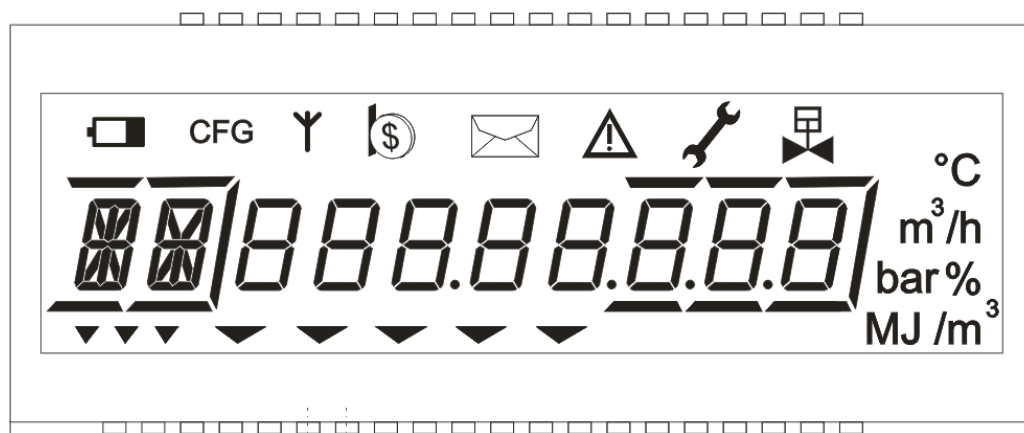

The display type is black and white LCD with 1 line consisting of 2 British flag characters, of 13 and 12 segments respectively, and 8 7-segment characters. There are also a series of icons and symbols, the meaning of which is shown below.

The size of the digits represented by the 8 7-segment characters are compatible with the requirements of MID and EN 12405-1

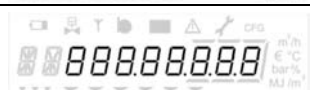
The construction technology of the LCD element (display) is such as to assure a lifetime of over 15 years under operating conditions which include also prolonged exposure to sunlight.



The meaning of the graphical elements is outlined in the following table:

	Explanation field	2 Characters in British flag (the first in 13 segments, the second in 12 segments) and 5 highlighters
	Numeric Field	8 Figures 7-segment
	Flag Field	5 Arrow indicators
	Flow Rate Field	3 Arrow indicators
	Decimal points	3 points in correspondence of the least significant digits (to the right) 1 point in correspondence of the fifth digit
	Highlighters of decimal digits	3 lines in correspondence of least significant digits
	Icons field	See table for Icons
	Units of measurement Field	See Unit of Measure table and other symbols

To allow a long battery life, the display is usually kept OFF. To use it, simply press the operator button for at least 3 seconds (configurable).

6.2.1 Display testing capabilities

On the main page, after the key is pressed for a long time, a test sequence is displayed to check the presence of defective segments or icons. The test sequence simultaneously illuminates all segments of the display, and then turns them off.

6.2.2 Explanation field







It consists of two alphanumeric characters (a British flag, the first 13-segment, the second 12 segment). Its content varies depending on the displayed page and, in case of data pages, it synthetically indicates the meaning of the numeric field; in the case of pages related to the chapters, it indicates an abbreviation of the numeric field.

6.2.3 Data field

It consists 8 7-segment digits. In case of pages related to chapters, it shows the title of the chapter itself, while in the data pages it reports the value of the corresponding data.



6.2.4 Icons and symbols

The following tables describe the icons and symbols on the display.

Icon	Description	ON	Flashing
	Low battery	Battery to be replaced as soon as possible (residual charge $\leq 10\%$)	Low battery to be replaced (stop of the measurement functions)
	Communication	Active communication	Communication error or insufficient field level
	On-off valve	Not used	
	Payment	Used only for the "pre-payment" option	
	Envelope		Message to the user ⁶
	Diagnostics	In the presence of diagnostic signals ⁷	
	Maintenance	System in a state of "Maintenance"	System in a state of "Replacement"
CFG	Configuration		System in a state of "Not Configured" or "Factory"



6.2.5 Measurement units and other symbols

Icon		Meaning	Remarks
bar		When a pressure value is displayed	
°C		When a temperature value is displayed	
m ³		When a volume value is displayed	
/h		When displaying a flow rate (together with m ³)	
MJ		When an energy rate is displayed	

/m ³		When a PCS is displayed (along with MJ)	
€		When a monetary value is displayed	Used only in the "prepayment" option
%		When a percentage is displayed	
	1, 2, 3 (Flow rate range)	Normally lit, they flash if the measured flow rate is different from zero	Icons are placed under the explanatory field
	1..5 (Flag field)	If on alternatively, they indicate the number of the upper chapter	Icons are placed under the numeric field

⁶ the flashing is removed when the message has expired or has been read

⁷ the icon is activated in the presence of new alarms and remains activated until its reset

	1, 2, 3, 5 (decimal points)	When lit alternatively, they indicate the position of the decimal point relative to the numeric field	Between one digit and the other of the numeric field each in its decimal place
	1, 2, 3	Highlighters of decimal digits, they are lit concurrently with the decimal point of equal or greater position.	Segments above and below (for the first one also from the side to the right) of the corresponding digits of the numeric field

7 Menu structure

This section shows the hierarchy of the pages making up the user interface.

Under normal operating conditions, the display is completely off. Pressing the single button, the display turns on and performs a lamp test in which all segments and icons are lit simultaneously and subsequently switched off. After the test, it displays the contents of the main page.

The absence of a key activation for more than 20 seconds (configurable by means of object CTR – FioTec®) returns the status display to off.

The information is organized in "chapters"; each chapter consists of "pages." During the display of pages of a particular chapter, the flag field indicates to which chapter, from 1 to 5, the pages being displayed do refer.

The interaction occurs through the single button on the front of the system. By activating the button, with long or short press, you can follow the page hierarchy. The duration threshold that discriminates the long pressure from the short one is configurable via the proprietary CTR object (FioTec®)

Depending on the pressure and duration of the currently displayed page, the activation of the button can take on different meanings, summarized in the following table:

Key	Main page	Chapters Pages	Data pages
Short press	Change view of the totalizer between V and Vb	Next chapter page	Next data page
Long press	First chapters page	First below data page	Back to the top chapter

7.1 Main page

Pressing the front button activates the display of the main page, described below.

Explanation field	Numeric field	Flag Field	Remarks
Vb	6 integers and 2 decimals		Totalizer of Vb volumes (converted to thermodynamic conditions of reference) (m.u. = m3)
V	6 integers and 2 decimals		Totalizer of volumes V (corrected through flow rate correction function) (m.u. = m3)

The Vb and V magnitudes are displayed in the order shown above, after briefly pressing the button.

The long press of the button in correspondence of one of the two pages activates the display of the subsequent chapters.

7.2 Chapters

The 5 chapters provided by the operator interface, are indicated in the explanatory field (indication of Chapt ) in the numeric field (chapter title) and in the flag field (chapter number) as follows:

Explanation field	Numeric field	Flag Field	Remarks
GE	GE _n	GEN	General parameters chapter
PC	Pt-corr	PTC	Chapter of data related to the period of the current Billing
PP	Pt-PrEc	PTP	Chapter of data related to the period of the previous billing
AP	APPArAt0	APP	System chapter
SE	SEr	CFG	Service chapter

The brief activation of the key causes the transition to the next chapter. Once the last chapter is reached, the sequence resumes from the main page. The long activation of the key causes the display of the first page below the chapter.

The pages of each chapter are shown in the sequences indicated in the following paragraphs, that can be listed with a short press of the button. Once the last page of each chapter has been reached, it resumes from the first one of the same chapter.

On any page of a chapter, the flag field indicates to which chapter the page belongs, by illuminating that of the 5 graphic elements that corresponds to it.

On each page of a chapter, the long press of the key allows you to return to the home page of the chapter in which it is located.

REMARK: Since HM foresees the possibility to configure the sequence of chapters and pages belonging to them, and to define new pages containing other information, selected from among those present on the unit itself, the following is the default sequence of pages and chapters. The menu configuration can also be made remotely using CTR objects in the proprietary area (FioTec®). For information on the menu configurability, see Annex A3

7.2.1 Chapter of General Parameters (GEn)

Explanation field	Numeric field	Flag Field	Remarks
RS	Company Name of the end customer (the 30 characters scroll from right to left with an interval of 0.3 sec)	GEN	If the field Company Name is empty because not configured, the page does not appear
Mn/Mo*	Message (the 24 characters scroll from right to left with an interval of 0.3 sec)	GEN	Mn if the message is new; Mo if the message was displayed earlier; if there is no message or the message as already expired or it is not to display yet, the page does not appear
Id	14 digits that scroll from right to left with an interval of 0.3 sec)	GEN	Redelivery Point (PDR) ID
dc	dd-mm-yy	GEN	Current date: date format (dd), month (mm), year (yy); e.g.: 15-07-11 for 15 July, 2011
Hc	hh-mm-ss	GEN	Current time; hour format (hh) .Minutes (mm) seconds (.ss); e.g. : 09-58-45 for 09h,58' and 45" that, if configured, considers daylight saving time
Sd	CnF FAb nC SEr SoS	GEN	It indicates the operating status of the device including: CnF = normal (configured) FAb = factory status nC = not configured SEr = status of service or maintenance SoS = status of replacement
EV	xxx-yyy	GEN	Events in the metrological log xxx= number of events present yyy= number of events still writable
bH	xx	GEN	Charge level of the battery of the HM measurement group as a percentage (e.g.: 30 → residual charge =30%)
bC	xx	GEN	Charge level of the battery of the communicator (HMCom) as a percentage
dG	See Table 2	GEN	Information on the diagnostics status: in this page and in the following ones any alarms present and coded according to Table 2 are presented
*) the message is considered already read when the appropriate page of the General chapter has been read			

Table 2

explanation field	numeric field	flag field	Meaning
DG	-----	Flg_1	No Alarm
DG	02-BAtt	Flg_1	Emergency battery (remaining capacity <10%)
DG	03-rE90	Flg_1	Logs event more than 90%
DG	04-MALFUNCTION	Flg_1	Generic meter failure
DG	05-rE100	Flg_1	Event log is full
DG	06-Orol	Flg_1	Clock disalignment
DG	08-Db	Flg_1	Corrupted database
DG	11-T-Fr	Flg_1	Gas temperature out of range
DG	12-P-Fr	Flg_1	Gas pressure out of range
DG	13-PrFr	Flg_1	Flow rate out of limit
DG	15-HP	Flg_1	Abnormal consumption
DG	18-ErrEC	Flg_1	Optical encoder failure
DG	19-PrL	Flg_1	Leakage
DG	20-Con	Flg_1	Failure of communication module

The alarm icon is present until the source of the alarm is present; even in the absence of alarm the icon remains on, until it is not carried out a long press of the button on the page "rESEtTA". The reset of alarms changes the text field (CN) of the page from "rESEtTA" to "Done"

This page appears at the end of the chapter GENErALI only if there are alarms and its related logical seal is disabled.

The alarm icon will remain on until the cause of such an alarm disappears, with the subsequent deletion of the alert.

7.2.2 Current Billing chapter (Pt-corr)

Explanatory field / Range Field	Numeric field	Flag Field	Remarks
Pt	aa-nnn	PTC	Identification of the tariff program in place (e.g.: 11-001)
F1, F2, F3	hh.00 (end time of the current Range)	PTC	Current tariff range and time when the field change will occur
Vb	6 integers and 2 decimals	PTC	Volumes totalizer Vb (udm= m ³)
V	6 integers and 2 decimals	PTC	Volumes totalizer V (udm= m ³)
Σ1	6 integers and 2 decimals	PTC	Volumes totalizer Vb in range 1 (udm= m ³)
Σ2	6 integers and 2 decimals	PTC	Volumes totalizer Vb in range 2 (udm= m ³)
Σ3	6 integers and 2 decimals	PTC	Volumes totalizer Vb in range 3 (udm= m ³)
ΣA	6 integers and 2 decimals	PTC	Volumes totalizer V in alarm (udm= m ³)
Qc	1 integer 3 decimals	PTC	Maximum conventional flow rate (m.u.. = m ³ /h)

7.2.3 Previous Billing chapter (Pt-PrEc)

Explanatory field / Range Field	Numeric field	Flag Field	Remarks
Pt	aa-nnn	PTP	Identification of the previous tariff program (ex.: 11-001)
DF	dd-mm-X	PTP	date (day-month) in which the previous billing period has been closed, X = 1-6, P,F,C,V,D,A indicates the reason for the closure; if 1-6 the closure is for normal periodicity every x months P= the closure was performed for entry into force of a new tariff plan C= the closing is due to change of supplier (switch) F= the closure is due to change of seller (switch) C= the closing is due to change of contract (switch) D= the closure is due to change of distributor V= the closure has been carried out for perfecting of the final customer A= other reasons
Vb	6 integers and 2 decimals	PTP	Volumes totalizer Vb (udm= m ³)
V	6 integers and 2 decimals	PTP	Volumes totalizer V (udm= m ³)
Σ1	6 integers and 2 decimals	PTP	Volumes totalizer Vb in range 1 (udm= m ³)
Σ2	6 integers and 2 decimals	PTP	Volumes totalizer Vb in range 2 (udm= m ³)
Σ3	6 integers and 2 decimals	PTP	Volumes totalizer Vb in range 3 (udm= m ³)
ΣA	6 integers and 2 decimals	PTP	Volumes totalizer V in alarm (udm= m ³)
Qc	1 integer 3 decimals	PTP	Maximum conventional flow rate (m.u.. = m ³ /h)

7.2.4 System (APPArAtO)

Explanation field	Numeric field	Flag Field	Remarks
SM	FIO-xxxxxxxxxxxx	APP	HM serial number, presented with the scroll technique
SC	FIO-xxxxxxxxxxxx	APP	HMCom serial number, presented with the scroll technique
Ck	CRC16	APP	CRC16 of HM Firmware 4 hexadecimal digits

FM	x.y.zz	APP	Firmware version HM x: major; y: minor; zz: revision
FC	xx.yy	APP	Firmware version HMCom xx: major; yy: minor
SP	xxxxxxxxxxxx	APP	Identifier of pressure sensor (12 digits). Presented with the scroll technique.
St	xxxxxxxxxxxx	APP	Identifier of temperature sensor (12 digits). Presented with the scroll technique.
FD	[id software] [Event date and time] [profile] [user]	APP	Update fw events completed successfully
FK	[id software] [Event date and time] [profile] [user]	APP	Update events completed with errors

7.2.5 Service (Ser)

Explanation field	Numeric field	Flag Field	Remarks
Vb	6 integers 2 decimal (including non significant zeros)	CFG	totalizer of volumes converted to thermodynamic conditions of reference (m.u. = m ³)
Rb	5 integers 3 decimal (including non significant zeros)	CFG	remainders of volumes: it represents the totalizer of volumes at reference conditions with a greater detail of decimal digits (m.u. = m ³)
V	6 integers 2 decimal (including non significant zeros)	CFG	corrected volumes totalizer (flow rare correction) (m.u. = m ³)
R	5 integers 3 decimal (including non significant zeros)	CFG	remainders of corrected volumes: it represents the totalizer of corrected volumes with a greater detail of decimal digits (m.u. = m ³)
Vm	6 integers 2 decimal (including non significant zeros)	CFG	measured volumes totalizer (m. u.= m ³)
Rm	5 integers 3 decimal (including non significant zeros)	CFG	remainders of volumes: it represents the totalizer of measured volumes with a greater detail of decimal digits (m.u. = m ³)
t	2 integers and 1 decimal	CFG	It is the temperature value of the gas in °C with sign
tb	2 integers and 1 decimal	CFG	It is the temperature value of reference in °C with sign
P	1 integers and 5 decimals	CFG	It is the pressure value of the gas in bars
Pb	1 integers and 5 decimals	CFG	It is the value of the reference pressure in bars
ISO12213-3		CFG	Formula used. ⁽¹⁾
Zi	1 integer 5 decimals	CFG	Compressibility Z posted, displayed only if ≠ 0.
Z	1 integer 5 decimals	CFG	Compressibility Z of measurement. ⁽¹⁾
Zb	1 integer 5 decimals	CFG	Compressibility Z of reference. ⁽¹⁾
C	1 integer 5 decimals	CFG	Conversion factor
Cf	1 integer 5 decimals	CFG	Correction coefficient
C0	2 integers and 2 decimals	CFG	Percentage of CO ₂ concentration. ⁽¹⁾
H2	2 integers and 2 decimals	CFG	Percentage of H ₂ concentration. ⁽¹⁾
d	1 integer 5 decimals	CFG	Relative density. ⁽¹⁾
HV	2 integers and 2 decimals	CFG	Superior calorific power (MJ/m ³). ⁽¹⁾
tH	2 integers and 2 decimals	CFG	Combustion temperature (°C). ⁽¹⁾

⁽¹⁾ Displayed only when Zi = 0.

7.3 Configurability of the pages and chapters

It is forecast the possibility to set up to 10 additional pages (through CTR objects) by specifying:

- Explanatory field (2 characters);
- Id of the CTR object to be displayed;
- Number of decimals
- Units of measurement.

For more details, see Annex 3

8 Configuration

The configuration of parameters necessary for the operation of the device takes place through the doors of local and remote communication. Changing parameters with metrological value is allowed either locally or remotely by authorized personnel through authenticated commands, with authentication algorithm based on AES128 and utilizing a 64-bits footprint.

Any change of the parameters with a metrological value is recorded in the event log metrology with the following information:

- progressive number of the event
- date and time of the event:
- operator's own identification code or center that generated the change
- totalizer value of volumes at the modification moment
- unique identifier of the changed parameter
- old parameter value (if provided)

The local and remote communication software made available to Fiorentini is as follows, respectively:

- 1) Xterm PC – local communication software for PC platform, Windows XP or higher
 - 2) SAC – Central Acquisition System - data collection center with IP communications support, GSM and SMS.
- Details of the two products in question are reported within the respective user manuals.

9 Maintenance

9.1 Ordinary Maintenance

Before any maintenance work, which interferes with normal functioning, HM should be placed in an appropriate state of "maintenance." The activation state of maintenance can be carried out ONLY from the terminal X-Term or equivalent starting from the NORMAL status. The status of "maintenance" is detectable both locally and remotely. During a maintenance session it is not possible to perform write operations remotely. The status of maintenance is also visible via the display icon.

In the maintenance status it is inhibited only the logging of process events abnormality (range P, T, Q, calculations, etc...). The other events (e.g. such as changing the parameters) are normally generated and recorded. Please refer to **Errore. L'origine riferimento non è stata trovata.** for details.

9.1.1 Battery Replacement

The HM battery is sized to assure an autonomy of more than 15 years under normal environmental and operating conditions and, therefore, it is not necessary to replace it.

9.1.2 Calibration in the field

The field calibration allows to correct errors due to aging of the meter and sensors.

Calibration is an activity protected by metric seal (software seal) removable only by authorized personnel.

Any calibration operation shall be recorded in the Events Log.

To calibrate the meter of gas volumes it is necessary to be connected to the system through the optical port and have the references for the flow rate measurement with a higher accuracy than that of the system (at least $\pm 0,5\%$ for flow rates going from Q_t to Q_{max} and 1% for flow rates from Q_{min} to Q_t).

Calibration is done by means of an appropriate software that calculates the correction coefficient to be applied to the counter in relation to the ratio between Q_{mis}/Q_{eff} , being Q_{mis} the flow rate value measured by the counter, and Q_{eff} the flow rate value measured by the reference meter

Calibration can be performed on field, on the scope of work while in the laboratory it should be performed on at least two points (Q_t and Q_{nom})

The on field calibration of the pressure transducer is allowed provided that its drift is contained within $\pm 10\%$ of the actual value The calibration of the pressure sensor can be performed on the field on at least two points selected in the nominal range of the sensor

The recalibration of the meter for gas volumes and the pressure sensor on field should be carried out by authorized and trained personnel, trained to operate with the correct procedure

9.1.3 Firmware update

In case of release of a new firmware version, the notes that describe the changes made since the previous version are distributed.

The firmware update can easily be performed also remotely. Contact Fiorentini for further details

9.2 Corrective maintenance

No corrective maintenance operation is executable by the user. In case of malfunction contact your service agency service@fiorentini.com

9.2.1 Status of Replacement

The status of "replacement" is triggered to allow the safe battery disconnection. All replacement operations (with the exception of the communication module) should occur at off system.

The status of replacement can be activated starting from the status of "maintenance" through the "execute" function of the CTR - FioTec® but after removing the special seal. The replacement status is deactivated after timeout or after a power on. The timeout output returns the system to "normal" status.

The entry into the state of "replacement" foresees:

- saving the status of the temporary key and the remaining activation time;
- saving all totalizers;
- saving the device status (replacement status);
- saving the time and date.

In the status of "replacement" all memory saving activities are inhibited. They are therefore excluded all data consolidation operations, trace saving and event generation.

9.2.2 Replacing the electronics section

HM allows the replacement, while operating, of the control electronic card housed within the plastic outer container. Replacing may be necessary for the following reasons:

- failure of one or more electronic components
- failure or malfunction of the display
- failure or malfunction of the button

The replacement is made possible because the temperature and pressure sensors and the DMP memory that contains all calibration and configuration parameters are located inside the plastic body on another electronic card and are not concerned by the replacement. In addition, the electronic cards are identical between, them not having components that have to be specifically calibrated to the metering activity.

The replacement of the card must be carried out by authorized and trained personnel, trained to operate with the correct procedure

The replacement procedure, if the electronics to be replaced is still functioning, must be activated via the terminal connected to the ZVEI port and it plans to place beforehand the HM in the "maintenance" status, then to prepare, with the appropriate command, the electronics replacement (replacement status). Thereafter, the HM command logs the event in the metrology log of the internal memory and then goes into a state of "idle", during which it inhibits all functions of measurement, communication and access to the internal memory: the status of inactivity is maintained for a user-defined time (default is 30 minutes), after which a new event is generated, and all normal functionalities are restored.

After replacing the electronic card the microprocessor that equips the new card, as soon as it is power supplied, performs the check procedure of the system codes that are contained in the card memory, with those contained in the DMP. The inconsistency of the data contained in the microcontroller memory determines the data update in DMP and the logging of the event "HM module replacement"; furthermore, once it has examined the previously saved replacement status, it resets the date and time and the duration of the maintenance key previously saved; then it reaches the maintenance status and restarts the regular measurement and control activities.

9.2.3 Replacing the battery

The HM battery is sized to assure an autonomy of more than 15 years under normal environmental and operating conditions and, therefore, it is not necessary to replace it.

If the equipment is used in very different operating and/or environmental conditions than normal, it may be that the battery runs out before the 15 years forecast. To avoid the fact that an early exhaustion of the battery requires a replacement of the entire HM, the replacement of the battery alone has been forecast

Replace the batteries only when the low battery icon appears on the display or the related event is intercepted.

Battery replacement must be performed by authorized and specialized personnel.

Battery replacement requires that HM is placed before in the "maintenance" status and then in "replacement" status.

Upon battery insertion and subsequent power-up, the battery replacement must be confirmed by the function execute F_SOSBAT, which determines:

- the reinitialization of the battery consumption data.
- Event logging of battery replacement.

Furthermore, upon power on, HM also examines the status of previously saved replacement; restores the maintenance status and the duration of the maintenance key previously saved.

9.2.4 Replacement of temperature and pressure probes

HM-M allows the replacement during the operation of the pressure and temperature transducers. Replacing may be necessary for the following reasons:

- failure
- drifting of the measurement beyond the permissible limits ($\pm 10\%$)

The replacement is possible because the temperature and pressure sensors are of a digital type and have inside a memory that contains all the calibration parameters performed at factory. The temperature and pressure sensors can be replaced with identical sensors produced and calibrated by Pietro Fiorentini SpA .

Sensors replacement must be performed by authorized and specialized personnel.

The replacement of sensors must be activated via the terminal connected to the ZVEI port and it foresees to place beforehand HM-M in "maintenance" status, then to prepare the electronics, with an appropriate command, ready for replacement, then to turn off the unit by unplugging the battery connector.

After replacing and re-supplying the system, the microprocessor that equips the card checks the change of one or more sensors, comparing the identifiers of the sensors with those recorded in the DMP; any difference will determine:

- saving in DMP the new codes of the replaced sensor;
- the reset to the default values of the calibration parameters of the replaced sensors;
- event logging of sensor replacement

Furthermore, upon power on, HM after examining the status of previously saved replacement; restores the date and time of the maintenance key previously saved, then returns to the maintenance status.

The identifier of the sensors in use is also visible on the display in the "system" page

10 Technical characteristics

10.1 General Features

Parameter	Features	
Enclosure	Main body	PC-ABS
	Transparent cover	Polycarbonate
Protection degree	IP 65	
Dimensions (overall)	Max 460(H) x 397(L) x 327 (P) mm	
Display	Black and white LCD type TN by 112 segments	
Keyboard	one front operator key	
Operating/storage temperature	-25°C to +55°C / -25°C to +60°C	
Humidity	≤ 93%	
Certifications	ATEX (Ex ib 2G IIB T3 Gb), MID	
Power supply	Type	3.6V lithium battery
	Format	Proprietary set
Autonomy	Main battery	> 15 years () (see par 10.3)
Microprocessor	type RISC at 16 bits	
Code memory	128 Kbyte of Flash type	
Data memory	Type	EEPROM 128Kbits
	Data retention	≥ 20 years
Processing cycle	< 300mS (ISO12213-3)	
Real Time Clock	RTC with management of daylight saving time and leap years Accuracy according to EN62054-21	
Accuracy	Reference conditions	± (1.5% + 0,5%) (according to MID)

10.2 Communication ports

Parameter	Features	
Local communication port	Physical layer	ZVEI (IEC 1107)
	Speed	9600baud
	Application layer	protocol CTR

10.3 Power Supply Devices

HM can ONLY be power supplied by a separate approved battery pack.

The battery pack is a proprietary assembly consisting of a lithium battery and a terminated cable with a special connector, coated by a protective sheath and called "LITHIUM BATTERY PACK".

The battery pack is a device certified for exclusive use with the HM-M device and it is the only permissible power supply device.

Caution!

Use only batteries of the type and model complying with the original

The connector of the battery pack is polarized in such a way as to fit only in the connector specifically provided for on the device, observing the correct polarity.

The following data are printed on the battery pack:

- Model
- Serial number

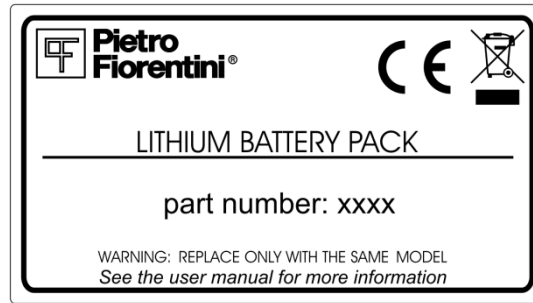

Fig. 12 - Battery pack Label

The battery is not replaceable in the hazardous area and its access is allowed only through the use of dedicated equipment.
The battery pack is sufficient to provide an autonomy of not less than 15 years in the following reference operating conditions:

<i>Conditions</i>		
<i>Room Temp.</i>	5% <i>weather @ -25°C;</i> 20% " @ -10°C; 50% " @ 22°C; 20% " @ 55°C; 5% " @ 70°C;	
<i>Communication</i>	<i>Once every 3 days</i>	<i>Registration to the GSM network = 20sec. ; Communication=25sec.</i>
<i>Display</i>	<i>activation 2 minutes every 3 days</i>	<i>or a full view of all the possible screens (excluding maintenance), each lasting for 10 sec.</i>
<i>Measure T and P and calculation of Vb</i>	<i>1 measurement every 30 sec</i>	
<i>Range</i>	<i>Qmax</i>	<i>Pulse repetition is active in mode: 1 pulse every 100 liters</i>
<i>Downloading</i>	<i>1/year</i>	
<i>Local Communication</i>	<i>5 minutes per month.</i>	

10.4 Output for communication to the User

The measurement groups of the family HM (HM-10, HM-16, and HM25) are all equipped with exit FOL (Fiorentini Opto Link) used to communicate with the user equipment. Depending on the type of option forecast (I = impulsive; DI = data) it is provided, upon request, the adapter that converts the optoelectronic interface of the FOL in the most appropriate electrical characteristics for the connection to user devices.

The functional mode ("I" or "D") is selectable and configurable from both local (port ZVEI) and remotely with proprietary v protocol objects(FioTec®).

10.4.1 Interface of Pulse Emitter

In the modality "I" the output FOL can be configured to operate in the following modes:

- a) off (default)
- b) pulse repetition
- c) repeating of diagnostic status

In the "pulse repetition" mode, it is possible to configure at what size, Vb (default) or Ve, is associated the function, the division factor (2-1000, default 100) (see Annex A4)

In c) mode it is possible to configure a "mask" that indicates which bits of the diagnostic status (see reference DiagnR object of the CTR), when active, generate a pulse of 50ms repeated every 30 seconds until the alarm is active (see Annex A4)

The FOL interface of "I" type has the following electrical characteristics compatible with UNITS11291-6:

Max applicable voltage	< 15 Vdc
Minimum operating voltage	> 3.3 Vdc
Resistance in "closed" status	< 20 ohm @ Ic<10 mA
Resistance in "open" status	> 100 Kohm
Pulse duration	50÷ 100 ms

Here below the connection diagram follows

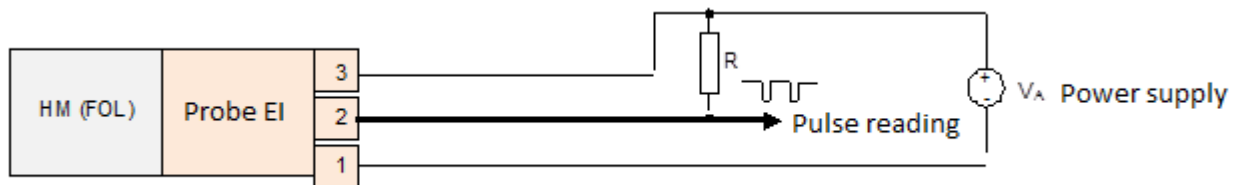

10.4.2 Serial Communication Interface

The operation mode "D" of the output allows two-way serial communication between HM and a user system that is able to communicate via this interface with CTR Protocol (UNITS 11291-3 to R131). A suitable interface (COMM) transforms the FOL output into a serial output according to RS 485 standard. It is forecast both the mono-directional communication mode (default) in the direction from HM to the user system, and the bi-directional mode of communication.

It is possible to configure from local (via ZVEI port) or remotely:

functionality	range	Note
mode	<ul style="list-style-type: none"> deactivates unidirectional bidirectional 	the bidirectional mode foresees both the "master" mode (HM "originate") and "slave" ("originate" user device)
frequency of data transmitting/receiving	multiple of 30 sec (max 240)	it is the frequency with which HM transmits or receives, awaiting a request from the user device
retry number	< 3	in bidirectional mode, it is the maximum number of repetitions in the absence of confirmation of HM; after each spontaneous HM transmission it awaits for 1 second the response of the user device
waiting time	1-10 seconds	in bidirectional mode "slave", it indicates the time in which HM awaits a command from the user's device at each frequency
data type	default=DECU (see CTR)	it is the data structure among those forecast by the CTR protocol that are transmitted spontaneously by HM to every periodicity

In case of FOL interface, type "D", the electrical characteristics and of transmission are the following:

Signal	Type	Description
VDC	Power supply	from 4.5Vdc to 15Vdc
GND	Mass	Negative reference
A	RS485	Asynchronous transmission signal with voltage levels according to standard RS485
B	RS 485	Asynchronous transmission signal with voltage levels according to standard RS485
Baud rate	1200 bps	
Format	asynchronous 1,8, N, 1	1 start bit, 8 data bit, no parity, 1 stop bit

Below follows the connection diagram:

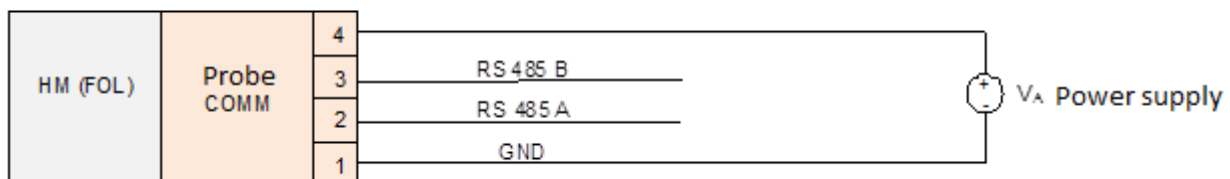

We indicate below the barrier models forecast for connecting the FOL interfaces:

-For FOL interface type "I": GM International D1031D

-For FOL interface type "D" : STAHL 9185/11-35-10 or alternatively GM international D1061-077

-For Power section: STAHL 9143/10-065-150-10 or alternatively STAHL 9143/10-065-200-10 or: STAHL 9143/10-065-200-20

10.5 Value added services (VAS)

These are the services implemented in the HM systems family not forecast by Del. 155-08 of AEEG, nor specified by UNITS 11291 but which, defined in the FioTec® scope create useful functions for distribution/sale of gas.

The measurement groups of family HM-10, HM-16, HM-25, implement the following VAS:

- Calculation of the maximum monthly conventional flow rate
- Flow rate overload detection
- Management of leaks
- Negative volume detection
- Time management in the collection range
- Consumption management in the collection range
- Check of the SLA (Service Level Agreement)

10.5.1 VAS - Calculation of the maximum monthly conventional flow rate

The 12 values of the maximum monthly conventional flow rate processed each month (one for each month of the year) with an indication of the day-time of the occurrence is made available through the proprietary CTR (FioTec®) objects. The calculation of the maximum monthly conventional flow rate is carried out at the end of the month.

10.5.2 VAS - Flow rate overload detection

When the conventional flow rate, calculated every 5', exceeds the meter overload Qr value, an alarm signal is generated (bit10 of diagnostics) and an event (31h code) is generated. If the conventional flow rate returns below the overload value, the current diagnostic is reset and the corresponding event is generated. The Qr overload is not a configurable parameter but it depends on the size of the system.

The service is useful to understand if the measuring group is correctly proportioned in relation to the plant's capacity and to detect any attempts of fraud

10.5.3 VAS - Leaks Management

During normal operation, a FioTec® service can be activated, which allows to detect any leaks (measurable) in the downstream plant of the metering unit (user plant). The service uses three algorithms developed by Pietro Fiorentini S.p.A. and it can be activated and configured using a special object (Qleak) of CTR in private domain (FioTec®)

If the service is active, every 5' HM checks for the existence of any leaks. When a leak is detected, it is activated the bit 26 of diagnostics; the bit stays on until the leak continues to be detected

10.5.4 VAS - Negative volume detection

Although the mechanical meter is provided with a mechanism for stopping the reverse gear⁸, HM is capable of measuring "negative" volumes, i.e. volumes that flow in the opposite direction to that of the meter. These volumes are not deducted from the volume totalizer with direct flow but are counted in a dedicated totalizer. This totalizer (not resettable) is available with an object CTR *Tot_Vn (obj.id B5.2.0)* in a private domain (FioTec®).

The service is helpful to understand if there are problems in the plant where it is installed the metering group (high amount of negative volumes), to identify any attempt of fraud, properly compute the user's consumption.

10.5.5 VAS - Time management in the collection range

During normal operation and every 5', HM enumerates (in multiples of 5') the time in which the conventional flow rate (at the measurement conditions) remained within 4 flow rate ranges as defined by configurable limits. The flow rate ranges and the time totalizer are available with CTR objects in private domain (FioTec®)

The service is useful to understand if the measuring group is correctly proportioned in relation to the plant's capacity and to detect any attempts of fraud. The service is also useful for profiling properly the user consumption modalities

10.5.6 VAS - Consumption management in the collection range

HM can count the consumption of gas in four different totalizers in relation to the instantaneous flow rate of the gas, according to the following

⁸ In the presence of negative gas flows it is possible to see a limited reverse rotation of the meter.

scheme:

Limits	Totalizer
$\leq Q_{min}$	Tot_Vm_Q1 (obj.id B0.1.6)
$Q_{min} < Q \leq Q_t$	Tot_Vm_Q2 (obj.id B0.1.7)
$Q_t < Q \leq Q_{max}$	Tot_Vm_Q3 (obj.id B0.1.8)
$Q > Q_{max}$	Tot_Vm_Q4 (obj.id B0.1.9)

Being Q_{min} , Q_t , and Q_{max} respectively the minimum flow rate, the transition flow rate and the maximum flow rate of the counter; Tot_Vm_Qx are 4 CTR items in private domain (FioTec®)

The service is useful to understand if the measuring group is correctly proportioned in relation to the plant's capacity and to detect any attempts of fraud. The service is also useful for profiling properly the user consumption modalities

10.5.7 VAS - Check of the SLA

The main battery is forecast to ensure the operation of the HM for 15 years under "average" operational conditions linked to "standard" conditions (see pf **Errore. L'origine riferimento non è stata trovata.**).

The remaining power of the main battery is estimated by HM according to the tasks accomplished: the estimate also provides for the assessment of the ambient temperature and aging (self-discharge) of the battery.

An abnormal activity of the system due to external demands (display power, number of remote broadcasts, configuration of the output for pulses retransmission, local communications), however, can reduce battery life significantly, even theoretically under 15 years of life provided by the system. If the equipment is used in operating and/or very different environmental conditions than normal, it may be that the battery runs out before the 15 years forecast.

For this reason we have forecast a CTR object (Diag_svc) in private domain (FioTec®) that can provide the information needed to assess the compliance of service SLA

HM constantly checks the consumption trend of the main battery: the diagnostic flag (bit24 of Diagn.) reports consumer conditions that exceed those expectations. The consumption test is performed by HM every month. In case of detection of an abnormal consumption it is also foreseen the generation of an event that is not metrological but in any case HM does not alter, nor stops any functionality.

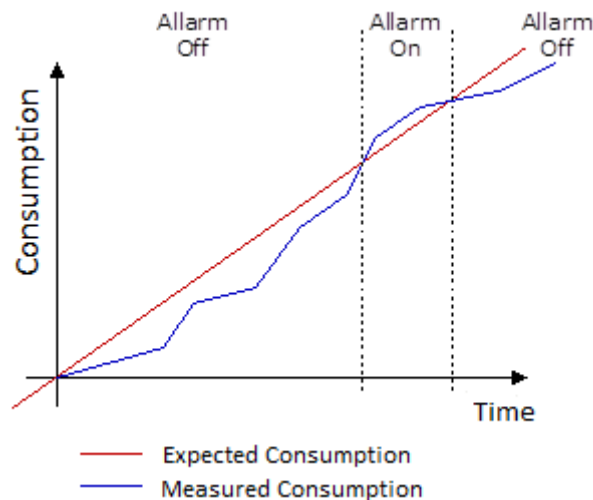

Object CTR - FioTec® : Diag_svc

N° Byte	Attribute	Value	Units of Measurement	Domain
2	.id	A0.0.0		
1	.qlf	xxh [-k]		
2	.val (tot_connections)	BIN		
4	.val (time_connection)	BIN	seconds	
2	.val (gprs_conn_duration_1)	BIN	seconds	
2	.val (gprs_conn_duration_2)	BIN	seconds	
2	.val (gprs_conn_duration_3)	BIN	seconds	
2	.val (gprs_conn_duration_4)	BIN	seconds	
4	.val (display_on_time)	BIN	seconds	
2	.val (display_on_times)	BIN		
4	.val (time_local_connection)	BIN	seconds	
2	.val (tot_local_connections)	BIN		
4	.val (time_temp_high)	BIN	seconds	
4	.val (time_temp_low)	BIN	seconds	
4	.val (tot_sms_sent)	BIN		
4	.val (time_tot_reg)	BIN	seconds	
4	.val (time_tot_conn)	BIN	seconds	
4	.val (time_tot_comm)	BIN	seconds	
4	.val (time_tot_modem_on)	BIN	seconds	
1	.access	00001111b		
54	.def	0		

name	description
tot_connections	total number of remote data connections performed (incoming and outgoing)
time_connection	total time spent in data remote communication (seconds)
gprs_conn_duration_1	number of GPRS connections made within 20 seconds
gprs_conn_duration_2	number of GPRS connections made between 20 seconds and 1 minute
gprs_conn_duration_3	number of GPRS connections made between 1 minute and 2 minutes
gprs_conn_duration_4	number of GPRS connections made in more than 2 minutes
display_on_time	total time for lighting the display (seconds)
display_on_times	number of display ignitions
time_local_connection	total time spent in communication
tot_local_connections	total number of local connections made
time_temp_high	time spent with ambient temperature > 40 ° C
time_temp_low	time spent with ambient temperature < -20 ° C
tot_sms_sent	counter of total number of sms sent
time_tot_reg	total elapsed time during recording
time_tot_conn	total time elapsed in the process of data connection
time_tot_comm	total time elapsed during data communication
time_tot_modem_on	total time elapsed with the modem turned on

Object CTR - FioTec® : TEMP_PROF

N° Byte	Attribute	Value	Units of Measurement	Domain
2	.id	A0.1.1		
1	.qlf	xxh		
4	.val (temp_profile1)	BIN	seconds	
4	.val (temp_profile2)	BIN	seconds	
4	.val (temp_profile3)	BIN	seconds	
4	.val (temp_profile4)	BIN	seconds	
4	.val (temp_profile5)	BIN	seconds	
1	.acces	00001111b		
3	.def	0		

name	description
temp_profile1	time in seconds elapsed at a temperature ≤ -17 °C
temp_profile2	time in seconds elapsed at a temperature > -17 °C and ≤ 6 °C
temp_profile3	time in seconds elapsed at a temperature > 6 °C and ≤ 38 °C
temp_profile4	time in seconds elapsed at a temperature > 38 °C and ≤ 62 °C
temp_profile5	time in seconds elapsed at a temperature > 62 °C

Annex A1

The following are the details of the events managed by HM. The events marked with the symbol (♣) are "metrological" events, the other events are "non-metrological"

Code	Meaning	HM	Remarks HM
30h	Generic		
31h (♣)	Out of limit	x (*)	The event is generated in correspondence of a conventional flow rate over the meter limit (Qsovrac) or of an ambient temperature over the operating limits provided by the system.
32h (♣)	Out of range	x (*)	The event is generated in correspondence of a reading of the temperature or the pressure outside the range allowed by the manufacturer.
33h	Programming	x	
34h (♣)	Editing of a relevant parameter	x	The event is recorded upon modification of the parameters used for the volumes compensation.
35h	General fault	x (*)	Refer to UNITS 11291-3 for fault codes
36h	Primary supply OFF		
37h	Battery low	x	An event generated on the occasion of exceeding the planned charging thresholds for both the HM battery and HMCom
38h (*)	Change date&time	x	
3Ah (♣)	Calculation error	x (*)	Error in compressibility v
3Bh (♣)	Reset database	x	An event generated on the occasion of execute F_RDB to restore to factory conditions and of the execute F_RDEF to restore the default values.
3Ch (♣)	Relevant seal de-activated	x	
3Dh (♣)	Synchronism error	x	
3Eh (♣)	Reset events queue	x	
3Fh (♣)	Daylight time programming	x	
40h (♣)	Events buffer is full	x	
41h (♣)	Configuration of tariff program	x	
42h (♣)	Entry into force of a new tariff plan	x	
43h (♣)	Configuring a new software	x	
44h (♣)	Entry into force of a new software	x	
45h	Reserved		
46 h	Attempted fraud	x (*)	Refer to UNI TS11291-3 for fraud codes
47h (♣)	Change of status	x	
48h	Programming failed	x	
49h	Flow rate cut-off		
4Ah	Pressure cut-off		
4Bh	Stopping the calculation of the volumes at reference term. conditions	x	
4Ch	Editing a safety parameter	x	
4Dh	Battery replacement	x	

(*) Events that are inhibited during the maintenance status.

Annex A2

Objects CTR (UNITS 11291-3 v. R131) implemented in HM

Description	ID	Mnem.	Trace	Sect Mem	Remarks
Category Flow Rate/Volume					
Flow Rate at conditions of measurement					
Measured instantaneous flowrate	1.0.0	Qm		N.A.	
Measured average flow rate in 1h	1.0.2	Qm_h	TRACE(h)	B3	
Flow rate at conditions of measurement					
In 1 day	1.1.3	Vm_g	TRACE(g)	B3	
Flow rate converted at basic conditions					
Average in 1 hour	1.2.2	Qb_h	TRACE(h)	B3	
Conventional	1.2.3	Qbc		N.A.	
Converted volume at basic conditions					
In 1 day	1.3.3	Vb_g	TRACE(g)	B3	
Conventional maximum flow rate converted to the basic conditions					
Conventional maximum flow rate in 1 day	1.A.3	Qbc_max_g	TRACE(g)	B3	
Maximum monthly converted conventional flow rate	1.A.4	Qbc_max_m	TRACE(m)	B3	
Maximum converted conventional flow rate during the current billing period	1.A.5	Qbc_max_pf		A1	
Maximum converted conventional flow rate during the previous billing period	1.A.6	Qbc_max_pfp		A2	
Volume at metering conditions into error					
In 1 day	1.F.2	Ve_g	TRACE(g)	B3	
Totalizers Category					
Totalizer of volumes at measurement conditions					
Current	2.0.0	Tot_Vm (♣)		A1	
Recorded at the end of 1 day	2.0.3	Tot_Vm_g	TRACE(g)	B3	
Recorded at the end of the billing period	2.0.6	Tot_Vm_pf		A2	
Totalizer of converted volumes at basic conditions					
Current	2.1.0	Tot_Vb (♣)		A1	
Recorded at the end of 1 day	2.1.3	Tot_Vb_g	TRACE(g)	B3	
Recorded at the end of the billing period	2.1.6	Tot_Vb_pf		A2	
Totalizer of volumes at measurement conditions in alarm condition					
Current	2.3.0	Tot_Vme (♣)		A1	
Recorded at the end of 1 day	2.3.3	Tot_Vme_g	TRACE(g)	B3	
Recorded at the end of the billing period	2.3.6	Tot_Vme_pf		A2	
Totalizer of volumes at reference thermodynamic conditions of in alarm condition					
Totalizer of converted volumes at basic conditions of range					
Current in range 1	2.5.0	Tot_Vcor_f1		A1	
Current in range 2	2.5.1	Tot_Vcor_f2		A1	
Current in range 3	2.5.2	Tot_Vcor_f3		A1	
Recorded at the end of the billing period in range 1	2.5.3	Tot_Vpre_f1		A2	
Recorded at the end of the billing period in range 2	2.5.4	Tot_Vpre_f2		A2	
Recorded at the end of the billing period in range 3	2.5.5	Tot_Vpre_f3		A2	
Energy category					
Energy totalizer					
Current	3.1.0	Tot_E		A1	
Category of absolute pressure					

Description	ID	Mnem.	Trace	Sect Mem	Remarks
Measurement pressure					
Instantaneous	4.0.0	P		N.A.	5 decimal digits
Average in one hour	4.0.2	P_h	TRACE(h)	B3	
Reference pressure for the conversion of volumes	4.9.1	Pb (♣)		B1	5 decimal digits
Preset pressure	4.9.5	Ppre (♣)		B1	automatic change at the entrance and exit of the maintenance status.
Temperature Category					
Measurement temperature					
Instantaneous	7.0.0	T		N.A.	2 decimal digits
Average in one hour	7.0.2	T_h	TRACE(h)	B3	
Day Degrees					
Calculated in 1 day	7.9.3	GG_g	TRACE(g)	B3	
Reference temperature for volumes conversion	7.B.1	Tb (♣)		B1	2 decimal digits
Combustion temperature of PCS	7.B.3	Tcb (♣)		B1	2 decimal digits
Preset temperature	7.B.6	Tpre (♣)		B1	automatic change at the entrance and exit of the maintenance status.
Operating ambient temperature	7.C.0	Tamb_fun		B2	
Other Temperatures					
Instantaneous ambient temperature:	7.2.0	Tamb		N.A.	
Category of Date & Time					
Date in extended format	8.0.0	Data&OraL		Info	
Date of reduced size	8.0.1	Data&OraS		N.A.	Drift from the extended
Closing date of Billing Period	8.0.2	Data&OraP		A2	
Shift of remaining time	8.1.2	Shift		B2	
Hour of Gas Day	8.1.3	OFG (♣)		B1	
Summertime	8.2.0	OL (♣)		B1	
Synchronization data	8.5.0	DSO		B2	
system Parameters Category					
All parameters	9.0.0	ALL_PA		B6	
System Manufacturer Code	9.0.1	CCODE		B6	Also saved in the internal Flash memory for card replacement verification
system identification code:	9.0.2	CIA		B6	
system Configuration Code	9.0.3	CCA		B6	
Firmware version	9.0.4	VF		C1	
system Class	9.0.5	ZIP code		B6	
Supported protocol version	9.0.7	VS_PRO		C1	
Synchronism type	9.0.9	SYNCT		C1	
Amplitude of events buffer	9.1.1	EMsize		C1	
Amplitude of alarm events buffer	9.1.2	EAsize		C1	
Amplitude of trigger events buffer	9.1.3	ETsize		C1	
Device serial number	9.2.0	NSA		B6	
Software identifiers	9.2.5	ID-SFTW		C1	
Network address	9.4.0	ADD		B2	
Parameters for Download	9.5.0	PADL		N.A.	
Category of Volumes Converter					
Conversion factor to the thermodynamic conditions of reference	A.0.0	C		N.A.	5 decimal digits
Compressibility Z of measurement	A.1.0	Z1		N.A.	5 decimal digits
Compressibility Z imputed	A.1.6	Z_i (♣)		B1	5 decimal digits
Compressibility Z at reference thermodynamic conditions (Zb)	A.1.7	Zb		N.A.	5 decimal digits
Instantaneous volume mass of current gas	A.3.0	pbgas		N.A.	5 decimal digits

Description	ID	Mnem.	Trace	Sect Mem	Remarks
Volume mass of gas entered	A.3.6	pbgas_i		B1	5 decimal digits
Instantaneous volume mass of current air	A.4.0	pbaer		N.A.	5 decimal digits
Volume mass of air entered	A.4.6	pbaer_i		B1	5 decimal digits
Density related to instantaneous air	A.5.0	Dgas		N.A.	5 decimal digits
Density related to entered parameter	A.5.6	Dgas_i(♣)		B1	5 decimal digits
Current instantaneous concentration N ₂	A.6.0	N ₂		N.A.	2 decimal digits
Current instantaneous concentration CO ₂	A.7.0	CO ₂		N.A.	2 decimal digits
Current instantaneous concentration HG ₂	A.8.0	H ₂		N.A.	2 decimal digits
Supported methods for calculating Z	A.B.1	Met_sp_Z		B6	
Active method for calculating Z	A.B.2	Met_Z(♣)		B1	Uneditable
Supported methods for calculating V	A.B.3	Met_sp_V		B6	
Active method for calculating V	A.B.4	Met_V(♣)		B1	Uneditable
Percentage of Hydrogen (H ₂) - entered	A.C.0	H ₂ _i(♣)		B1	2 decimal digits
Percentage of CO - Entered	A.C.1	CO_i(♣)		B1	2 decimal digits
Percentage of N ₂ – Entered	A.C.3	N ₂ _i(♣)		B1	2 decimal digits
Concentration of CO ₂ – Entered	A.C.4	CO ₂ _i(♣)		B1	2 decimal digits
Gross Calorific Value - Entered	A.C.8	PCS_i(♣)		B1	2 decimal digits
Category of Gas Analysis					
Current Superior Calorific Power	B.1.0	PCS		N.A.	2 decimal digits
Category of Plant Master Data					
Identification Code of Measurement Point	C.0.0	PDR(♣)		B1	
Number of managed channels	C.0.1	NCG		N.A.	
Company Name	C.0.6	RagSoc		B2	
Meter Master Data	C.2.0	An_CONT(♣)		B1	
Converter Master Data	C.2.1	An_CORR		B6	
Replaced Meter Master Data	C.2.2	An_con_old		B2	
Safety category					
Password of profile "0" (administrator)					
Administrator profile password	D.0.1	PSSW0_0		B2	
Password user #1	D.0.2	PSSW0_1		B2	
Password user #2	D.0.3	PSSW0_2		B2	
Password user #3	D.0.4	PSSW0_3		B2	
Password user #4	D.0.5	PSSW0_4		B2	
Password user #5	D.0.6	PSSW0_5		B2	
Password user #6	D.0.7	PSSW0_6		B2	
Password user #7	D.0.8	PSSW0_7		B2	
Password user #8	D.0.9	PSSW0_8		B2	
Password user #9	D.0.A	PSSW0_9		B2	
Server PUK	D.6.3	PUK_S		N.A.	
PIN of DCE					
PIN of DCE 1	D.7.1	PIN_0		B2	
PIN of DCE 2	D.7.2	PIN_1		B2	
KEY for encryption (profile "0")	D.8.1	KEYC_0(♣)		B2	
Factory KEY for encryption	D.8.6	KEYF(♣)		B2	
Temporary KEY for Encryption	D.8.A	KEYT(♣)		B2	
Status of Seals	D.9.0	S_Stat		B2	Saved only in case of activation of the seal.
Anti-fraud totalizer	D.A.0	T_antif		A1	
Communication category					
Periodicity and connection strategy to the Clients	E.0.1	PTXS_I		B2	

Description	ID	Mnem.	Trace	Sect Mem	Remarks
Mode of communication supported	E.1.5	CMODE		B6	
Server telephone references (DCE)					
Telephone Reference of DCE 1	E.2.1	Ntlf_S_1		B2	
Telephone Reference of DCE 2	E.2.2	Ntlf_S_2		B2	
Telephone references of the Clients with profile "0"					
Ref. #1	E.3.1	Ntlf_CO_1		B2	
Ref. #2	E.3.2	Ntlf_CO_2		B2	
Ref. #3	E.3.3	Ntlf_CO_3		B2	
Ref. #4	E.3.4	Ntlf_CO_4		B2	
Ref. #5	E.3.5	Ntlf_CO_5		B2	
Parameters for the Wake Up function	E.7.0	WU		B2	
Timeout of Communication Session (profile "0")	E.9.1	TOses_0		B2	
Maximum time between two consecutive messages from the sender	E.A.0	TOtrama		B6	
Maximum time of response to a message	E.A.1	TOresp		B6	Default = 30s
GSM/GPRS field strength					
Average GSM field for the DCE 1 - Instantaneous	E.C.0	GSM1		N.A.	
Average GSM field for the DCE 2 - Instantaneous	E.C.4	GSM2		N.A.	
Voluntary parameters	E.D.0	Spont_0		B2	
Status of communication with remote client	E.F.0	SCC		N.A.	
GPRS references of server					
GPRs reference of DCE 1	E.E.1	GPRS_S_1		B2	
GPRs reference of DCE 2	E.E.2	GPRS_S_2		B2	
Maintenance Category					
Battery Remaining time	F.5.0	TresBatt		A1	
Battery seconds of use	F.5.4	SuBatt		A1	Defined in Appendix B of the CTR
Events category					
Events	10.0.1	EventiS		B4	
Events	10.0.2	EventiA		B7	
Events on Trigger	10.0.3	EventiT		B5	
Events Number					
Registered in the buffer	10.1.0	NEM		Info	
Recorded in the alarms buffer	10.2.0	NEA		Info	
Total Registered Trigger events	10.3.0	NET		Info	
Executive Functions Category					
Delete Events tail	11.0.0	F_RCE		N.A.	
Set Data & Time	11.0.1	F_SYNC		N.A.	
Changing the device status	11.0.2	F_SMOD		N.A.	
Restore factory conditions	11.0.4	F_RDB		N.A.	
Edit/Enable Password	11.0.5	F_PSW		N.A.	
Disabling IT seals	11.0.6	F_DSIG		N.A.	
Enabling IT seals	11.0.7	F_ASIG		N.A.	
Replacing the battery	11.0.A	F_SOSBAT		N.A.	
Tariff Program Configuration	11.0.B	F_PT		N.A.	
Activate temporary key	11.0.C	F_AKT		N.A.	
Encryption key edit	11.0.D	F_MKC		N.A.	
Temporary encryption key edit	11.0.E	F_MKT		N.A.	
View/Print message	11.1.2	F_Print		N.A.	24 characters
Run connection (call)	11.1.7	F_Call		N.A.	
STATUS category					

Description	ID	Mnem.	Trace	Sect Mem	Remarks
Status of the device	12.0.0	SD		Info	
Diagnostics - Reduced size					
Diagnostics - extended current size	12.1.0	Diagn		N.A.	
Diagnostics - Reduced current size	12.2.0	DiagnR		N.A.	
Diagnostics- Reduced size recorded at the end of the billing period	12.2.6	DiagnR_pf		A2	
Historical Diagnostics - Reduced size					
Historical Diagnostics - Reduced size recorded at the end of 1 day	12.6.3	DiagnRS_g	TRACE(g)	B3	
Historical Diagnostics- Reduced size recorded at the end of the billing period	12.6.6	DiagnRS_pf		A2	
Message status	12.7.1	S_MSG		Info	
Category: I/O					
Digital outputs - Configuration	13.4.1	Conf_DO_1		B2	
Trace category					
Trace supported by the device					
Hourly	15.0.2	Trace_h		B6	
Trace active in the device					
Hourly	15.1.2	TraceA_h		B6	
Commercial Parameters Category					
Tariff program					
Current	17.0.0	PT_cor (♣)		B1	
Future	17.0.1	PT_fut (♣)		B1	
Billing Period	17.0.2	PerFat (♣)		B1	
Data Switch	17.0.3	Data_SW (♣)		B1	
ID-Tariff Program	17.0.4	ID-PT		A2	

CTR objects implemented in private area (FioTec®)

Description	ID	Mnem.	Trace	Sect Mem	Remarks
DCE Serial	8C.2.2	AN_DCE		B2	
Preparation for distributor switch	91.0.0	F_PSD		N.A.	
Edit all safety parameters	91.0.1	F_MAPS		N.A.	
Preparation for maintenance status	91.0.2	F_PSM		N.A.	
Input of Calibration status	91.3.0	F_SDP		N.A.	
Activate sensors replacement procedure	91.3.3	F_SostSens		N.A.	
Distributor code	97.0.0	DISCO		B2	
Territorial Unit of relevance	97.0.1	UOT		B2	
Service quality diagnostics	A0.0.0	Diag_svc		A1	
Private diagnostic	A0.0.1	DiagnP		N.A.	
CCID of SIM – DCE1	A0.0.6	SIMCCID_DCE_1		B2	
CCID of SIM – DCE1	A0.0.7	SIMCCID_DCE_2		B2	
Flow rate ranges	B0.0.1	Qsoglia_min (♣)		B1	
	B0.0.2	Qsoglia_t (♣)		B1	
	B0.0.3	Qsoglia_max (♣)		B1	
Totalizer by flow rate ranges	B0.1.1	TPF_1		A1	

Description	ID	Mnem.	Trace	Sect Mem	Remarks
	B0.1.2	TPF_2		A1	
	B0.1.3	TPF_3		A1	
	B0.1.4	TPF_4		A1	
Display Configuration - chapters	B2.0.0	CD_C		B2	
Display Configuration - page descriptors	B2.1.1	CD_DP_1		B2	
	B2.1.2	CD_DP_2		B2	
	B2.1.3	CD_DP_3		B2	
	B2.1.4	CD_DP_4		B2	
	B2.1.5	CD_DP_5		B2	
Display Configuration - pages configuration	B2.2.1	CD_CP_1		B2	
	B2.2.2	CD_CP_2		B2	
	B2.2.3	CD_CP_3		B2	
	B2.2.4	CD_CP_4		B2	
	B2.2.5	CD_CP_5		B2	
	B2.2.6	CD_CP_6		B2	
	B2.2.7	CD_CP_7		B2	
	B2.2.8	CD_CP_8		B2	
	B2.2.9	CD_CP_9		B2	
	B2.2.A	CD_CP_10		B2	
Start Calibration	B3.0.0	F_STARTCALI B		N.A.	
Stop Calibration	B3.0.1	F_STOPCALIB		N.A.	
Save Calibration	B3.0.2	F_SAVECALIB		N.A.	
Read Calibration	B3.0.3	READ_CALIB		B1	
Card serial number	B5.0.0	NSS		N.A.	Written in the testing of the microcontroller flash
Serial number of meter body	B5.0.1	NSC		B6	Written in testing
Flow rate for correction of the measured volumes	B5.0.2	Par_corr		B6	Written in testing
Date & time of calibration	B5.0.3	Data&OraT		B6	Written in testing
Cyclic volume	B5.0.4	Vol_cic		B6	Written in testing
Measured volumes	B5.0.7	Tot_VmP		B6	Written in testing
ID of temperature sensor	B5.1.0	I_Tsens		B2	
Identifier of pressure sensor	B5.1.1	I_Psens		B2	
Leakage management	B5.1.5	Qleak		B2	
Totalizer of volumes by flow rate ranges	B5.1.6	Tot_Vm_Q1		A1	
	B5.1.7	Tot_Vm_Q2		A1	
	B5.1.8	Tot_Vm_Q3		A1	
	B5.1.9	Tot_Vm_Q4		A1	
Totalizer of negative volumes	B5.2.0	Tot_Vn		A1	
High-resolution converted volumes	B5.2.2	Tot_Vbr		Info	
High-resolution measured volumes (corrected for the instantaneous flow rate)	B5.2.3	Tot_Vmr		Info	
Maximum time for synchronization without event	B5.2.5	S_SYNC		B2	
Spontaneous towards the user	B5.2.7	Par_Spont_U		B2	
Totalizer of incorrect volumes measured	B6.0.0	Tot_Vc		A1	
Measured volumes not high-resolution correct	B6.0.1	Tot_Vcr		Info	
Correction factor of measured volumes	B6.0.2	Cf		N.A.	

Annex A3

Req Id-001: [Menu configuration for the display](#)

It is possible to configure the display menus also remotely. The configuration allows you to change:

- *The sequence of chapters*
- *The sequence of pages within chapters*
- *The presence/absence of chapters*
- *The presence/absence of pages*
- *The explanatory fields of the pages*
- *The functional timeouts (persistence, for determining long-short activation of the button, etc.) "*

The Object CTR - *CD_C* in private domain (FioTec®) defines the sequence of the chapters display and at the same time which chapters are enabled.

The long press of the button allows you to enter the layer below the current chapter pages. The chapter number allows to detect the corresponding object CTR *CD_DP_x* (descriptor of pages) that defines the list of pages that are part of it. At the input of the chapter the first page displayed will always be the one corresponding to the zero index of the sequence. A long press of the button causes the return to the top level of the chapters.

The object *CD_DP_x* only defines the ID of the page to display. The page composition (explanation field, numeric field, etc.) cannot be changed.

It is also forecast the possibility to set up to 10 additional pages (through CTR – FioTec® objects) by specifying:

- Explanatory field (2 characters);
- Id of the CTR object;
- Number of decimals
- Flag of unit of measure

The fixed pages have an identifier from 1 to 100 while those variables range from 101 to 110. The configuration of pages with no displayable objects (example: tariff program) is not allowed

Example:

to display the value of the object *OFG* with *id=8.1.3*, you can define the page 101, configuring the object *B2.2.1 CD_CP_1*, for example, writing the value:

.val(id)	BIN	OFG	0x0813
.val(nd)		No decimals	0
.val(udm)	Bit justified	No units of measurement	0
.val(ce)	STRING	Mnemonic	"FG"

You must then program the sequence of pages of the chapter in which you want to view this page, so as to report the page 101. If you want to add this page to the chapter General (Chapter 1), you should program the object *B2.1.1 CD_DP_1* writing, in the 25 value fields, the identifiers of the pages (the 16 by default, the new 101 and 3 zeros to fill):

1, 2, 3, 4, 5, 6, 7, 8, 9, 10, 11, 12, 13, 14, 15, 16, **101**, 0, 0, 0

Annex A4

Configuration of FOL output as pulse emitter:

Table A4-1: object CTR *Conf_DO_1* (*obj.id 13.4.1*)

val	CTR Description	HM implementation
name	Output tag name.	„DOUT_1“
type	Bit 7: 0 = normally open; 1 = normally closed. Bit 0-6: 0 = Disable; 1 = Count; 2 = Alarm; 3 = Diagnostic Status; 4-5 = Reserved (=0); 6 = Available	Bit 7 = 0: the output, for reasons relating to the system consumption, is normally open (the field is not configurable). Bit 0-6: the values allowed by HM are 0, 1, 3 and 6. The bit 6 is used for the output configuration as bi-directional serial interface.
CAN	It is the channel number to which obj.id refers (1-24).	CAN = 1 (unchangeable fixed value).
obj.id	It is the identifier of the object whose .val attribute generates the status or count.	Applicable only with output configured with type = x1h. The CTR objects allowed for the generation of the count are: Tot_Vb; Tot_Vm Tot_Vme
prescaler	It is a divisor used only in the count type.	The value of the prescaler can be configured between a minimum of 10 and a maximum of 1000. The default value is 100 (a pulse every 100 liters).
mask	It is a mask whose bits at "1" indicate which active bits of the object DiagnR generate the activation of the output signal.	Applicable only with configured output, type 3. In the presence of an alarm the system generates a pulse every 30 seconds until its resolution.

Table A4-2: Pulses output - default values

val	N° Byte	Default	Remarks
name	10	“DOUT_1”	
type	1	00h	Normally open output; Deactivate status.
CAN	1	01h	Channel 1.
obj.id	2	0210h	Object CTR Tot_Vb.
prescaler	3	000064h	Prescaler equal to 100 liters.
mask	2	FFFFh	Enabling on all diagnostic bits.

The pulse output, if properly configured, is active in all states provided by the CTR protocol.

Configuration of FOL output as a serial data output:

The FOL output configuration to be used as a mono or bi-directional communication channel to the user system is realized by placing at 6 the "type" field of the object CTR - *Conf_DO_1* (*obj.id 13.4.1*).

One specific object CTR – *Par_Spont_U* (*obj.id B5.2.7*) in private domain (FioTec®) specifies the parameters and the functional mode of the serial output

Here below follows the structure of the object *Par_Spont_U*

N° Byte	Attribute	Value	Units of Measurement	Domain
2	.id	B5.2.7		
-	.qlf	0		
1	.val(mode)	BIN		see prospectus A4-1
2	.val(periodo)	BIN	seconds*30	
2	.val(struct)	BIN		see prospectus A4-2
2	.val(obj.id)	BIN		see prospectus A4-2
1	.acces	00000000b		
7	.def	-		

Prospectus A4-1:

val(mode) bit 0-3	val(mode) bit 4-7	Meaning	action
0 (default)	0	none	serial communication to the User shall not be carried out
1	0	unidirectional	the transmission of the structure does not await an answer
2	retry (1-3) (advised=1)	Bidirectional with confirmation	after forwarding it is awaited the confirmation within 1 sec; in the absence of a confirmation, the transmission is repeated for a maximum number of times indicated by "retry"
3	Time_rx (1-16) (advised=2)	"Inbound" mode	upon expiration of the period, the GdM enables the reception for "time_rx" seconds awaiting a Q() of one of the structures allowed for the function

Prospectus A4-2:

Attribute		Events	Array	Trace_C	TABLE	Private
val(struct)	Code of the structure to be transmitted spontaneously	56h	51h	53h	01-4Fh	81h – 82h
val(obj.id)	Identifier of the object	0	OBJ.id	OBJ.id	0	0